

Panasonic[®]

使用说明书
Operating Instructions

(家用) 电吹风
(Household) Hair Dryer

型号
Model No. EH-ND32/EH-ND21

中文	2
English	6

在使用本产品前，请仔细阅读本说明书并妥善保管，以备将来参考。
Before operating this unit, please read these instructions completely and save them for future use.

感谢您购买 Panasonic 电吹风。使用前请仔细阅读说明书所有内容。

部件名称

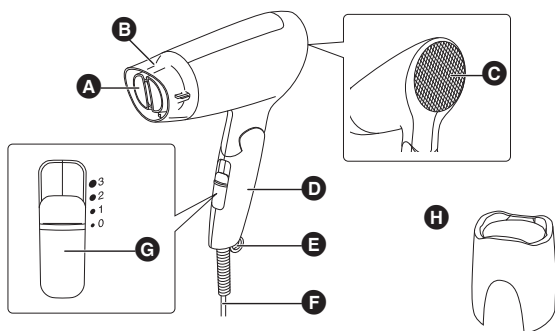

- A 出风口
- B 快干风嘴
- C 入风口
- D 手柄
- E 挂环
- F 电源线

- G 电源开关
- 3: 强风
- 2: 柔风
- 1: 冷风
- 0: 关

H 放置台 **EH-ND32 专用**

注意事项

使用电吹风前请先阅读安全说明。该安全说明能帮助您安全正确地使用电吹风，避免您伤害自己或他人。

警告：如果不遵守下列说明，可能会造成火灾、烫伤、短路或触电事故。

- 电吹风必须使用标准的家用电源插座，并且检查插座的输出电压，同时要与其它电器分开使用。
- 要确保所使用的电压与本产品标明的额定电压相符合。
- 绝对不能在电吹风启动的情况下离开。
- 使用完毕或使用中遇到停电时，必须从插座上拔下插头。拔出插头时，必须捏住插头从插座上拔出。
- 假如电吹风在运转时出现断断续续的情况，这时请立即停止使用。
- 不要用力拉扯电源线，不要损坏或改装电源线。将电源线缠绕在电吹风上可能会导致火灾或触电。假如电源线或插头损坏或变热，请立即停止使用。

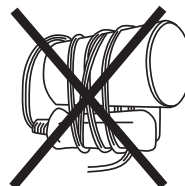

- 避免摔落电吹风或让电吹风受到强烈的撞击。
- 不要在石油气或其它易燃品（例如挥发剂、涂料稀释剂、喷雾剂等）附近使用电吹风。
- 电吹风必须安装固定在洗澡或淋浴时触及不到的地方并且电吹风的安装固定须保证手持部分在完全拉直时，洗澡和淋浴仍无法触及。

- 在浴室内使用时，使用后拔下插头，因为即使电吹风断电后，接近水仍存在危险，为了保障您的安全，建议在浴室供电的电气回路中安装一个额定漏电动作电流不超过 30mA 的漏电保护装置（RCD）。向 RCD 安装商咨询。
- 不要在手湿的情况下使用电吹风。不要把电吹风放置或存放在靠近水槽、有水或其它盛有液体、高度潮湿的地方。



不要在盛水的浴缸、淋浴、洗脸盆或其它器皿附近使用本电吹风。禁止在洗澡和淋浴时使用。

警告：电吹风上的该标志表示“请勿在洗澡或淋浴时使用本电吹风”。请勿在盛水的浴缸、淋浴、洗脸盆或其它器皿附近使用本电吹风。

- 不要使用稀释剂、苯和其它溶解剂来清洁电吹风。
- 在使用中小心不要让头发卷入入风口，不要把外物插入出风口和入风口，否则会导致机械损坏或触电。如在使用过程中入风口或出风口被堵塞时，可能导致加热器或者电吹风不能工作。假如出现这种情况，请立即停止使用，关闭电源开关并拔下插头，清除入风口或出风口的堵塞物。让电吹风冷却几分钟后，如果再次接通电源不能恢复正常工作时，请联系 Panasonic 授权维修中心修理。
- 在使用过程中，快干风嘴可能会变热，使用时请勿用手触摸快干风嘴。
- 不要直接将气流吹向眼睛或其它敏感部位。
- 请妥善处理本产品的包装袋，避免婴幼儿窒息等意外发生。请将电吹风置于儿童触摸不到的地方。请对儿童进行监督，避免其将本品视为玩具，引发危险。

- 本产品不宜供肢体、感官或精神上有残疾者、或缺乏经验和知识者（包括儿童）使用，必须有监护者从旁监督并对本产品的使用加以指导，且对使用者的安全能承担责任。
- 如果快干风嘴或电吹风受损，请勿使用。
- 不要将电吹风用于吹干头发和整发以外的其他用途。（如：吹干鞋子和衣物等用途，否则可能会引起外壳受热变形）
- 不要把非本公司提供的任何附件与本电吹风连用。
- 请注意电吹风的朝向并且不要使入风口距离头发太近。
- 使用时请让头发距离入风口 10 厘米以上。
* 否则可能会导致头发被吸入电吹风内。（图 1）
- 出风口和头发之间请保持 3 厘米以上的距离。（图 2）
* 否则可能会导致头发灼伤。
- 请妥善保管本使用说明书。



（图 1）

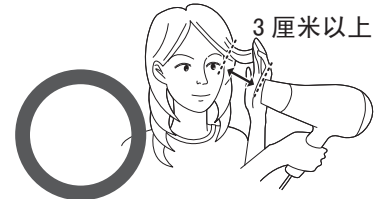

（图 2）

如何使用电吹风

1 用电源开关选择气流的强度。

● 注意

- 在使用电吹风之前，请先将电源开关设置在 [0] 位置，然后插入电源插头，并启动电源开关。
- 如想将头发迅速吹干，请按照下图所示的方向调整快干风嘴。

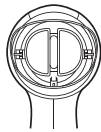

电吹风的保管方法

将带有快干风嘴的电吹风手柄折叠好放置在放置台上。

- 不要在接通电源的情况下将电吹风放置在放置台上。

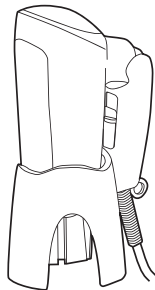

电吹风的修理和维护

- 请勿自行修理、拆卸或改装电吹风。

4

- 如果电源线或插头损坏，为避免危险，请立即停止使用，并联系 Panasonic 授权的维修中心进行更换。
- 如果使用热风时吹出的风经常变冷，并且电吹风内部时见到火花。请咨询或者联系 Panasonic 授权的维修中心进行维修。

● 出风口与入风口的保养（每月 1 次以上）

- 将电源开关置于 [1] 的位置上，边吹冷风边用牙刷清除出风口上的附着物。
- 将电源开关置于 [0] 的位置上，在关闭电源开关的状态下，用牙刷或吸尘器清除入风口上的灰尘或头发等附着物。

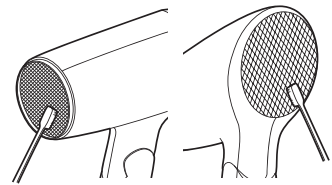

- 因为灰尘等会飘散，请注意。
- 如果灰尘等堵塞网眼，电吹风内部的温度控制开关将会启动，启动时常常会吹出冷风，导致干发和定型性能降低。
- 电吹风内部的温度控制开关是一种保护装置。操作时有时会出现火花，但是不会有危险。

型号规格

产品名称	电吹风	
产品型号	EH-ND32/EH-ND21	
额定电压	220V~ 50Hz	
额定功率	1200W	
尺寸	73(宽)×172(深)×202(高) 毫米	
附件	EH-ND32	快干风嘴、放置台
	EH-ND21	快干风嘴
原产地	中国	
生产日期	请见商品上刻印	
执行标准	中国国家标准	GB4706.1 GB4706.15 GB4343.1 GB17625.1
	企业标准	Q/SXDGWB 7

本产品仅适合家庭使用。

注意!

若不遵守以下安全措施可能会导致手指受伤。

展开手柄时

握住手柄或使用电吹风时，切勿接触下图中的阴影部分。

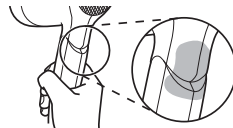

折叠手柄时

折叠手柄时，切勿接触下图中的阴影部分。

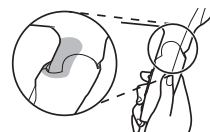

中文

Thank you for choosing a Panasonic hair dryer.
Please read all instructions before use.

Parts identification

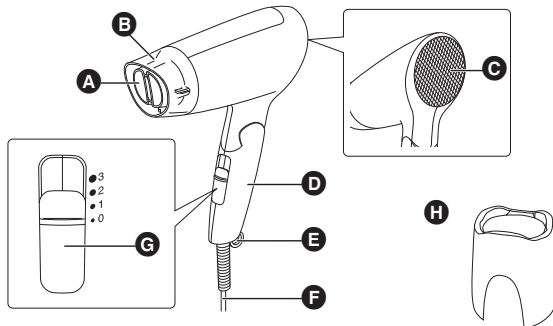

- A** Air outlet
- B** Quick-dry nozzle
- C** Air inlet
- D** Handle
- E** Ring for hanging
- F** Cord

- G** Main Switch
 - 3: Dry (Strong airflow)
 - 2: Set (Gentle airflow)
 - 1: Cool (Cool airflow)
 - 0: Off
- H** Stand **EH-ND32 only**

Important

Please read the safety instructions before using this hair dryer. The safety instructions explained here help you to use this hair dryer safely and correctly, and also to prevent you from injuring yourself or others.

WARNING: Not following the instructions below may cause fire, burns, explosion, short circuiting or electric shock.

- The electric power supply should come from a properly wired outlet. Also, check the capacity of the outlet and use the dryer separately from other equipment.
- Always ensure the voltage to be used corresponds to the voltage stated on the unit.
- Never leave the dryer running.
- After use or power cut, unplug it from the outlet. When unplugging, always grasp the plug and unplug it from the outlet.
- If the dryer blows air intermittently, discontinue use immediately.
- Do not pull the cord with unnecessary force. Do not damage or modify the cord. Wrapping the cord around the hair dryer may cause fire and/or electric shock. If the cord or plug is damaged or gets hot, discontinue use of the dryer immediately.

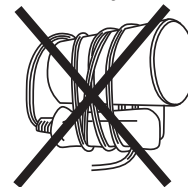

- Avoid dropping the dryer or subjecting it to other excessive shock.
- Do not use the dryer near gas or other inflammable materials (such as benzine, paint thinner, sprays, etc.).

- The hair dryer should be installed in places where it will not come into contact with water when the bath or shower is in use. This is necessary also when the handle of the dryer is extended.
- When the hair dryer is used in a bathroom, unplug it after use since the proximity of water presents a hazard even when the hair dryer is switched off.
- For additional protection, the installation of a residual current device (RCD) having a rated residual operating current not exceeding 30 mA is advisable in the electrical circuit supplying the bathroom. Ask your installer for advice.
- Do not use the dryer with wet hands or in the bath or shower. Do not use this hair dryer near water contained in bath-tubs, basins or other vessels. Do not leave or store the dryer near a tub, sink or other place where it will be exposed to water and other liquids or high humidity.



Do not use the dryer in a bath or shower.

WARNING: This symbol on the hair dryer means “Do not use this hair dryer near water”. Do not use this hair dryer near bathtubs, showers, basins or other vessels containing water.

- Do not use thinner, benzene or other solvents when cleaning the dryer.

- Be careful that hair is not sucked into the air inlet during use. Never insert foreign objects into the air inlet or outlet. Mechanical damage or shock can result. If the air inlet or outlet is blocked during use, the heater block or dryer may not operate. After removing the blockage from the air inlet or outlet, wait several minutes and the hair dryer should operate again. If not, please contact an authorized Panasonic service center.
- Avoid touching the quick-dry nozzle as it becomes hot during use.
- Do not direct the airflow towards the eyes or other sensitive areas.
- Please properly handle the product packaging bags to avoid accidents, such as infant and child choking. This appliance is not intended for use by persons (including children) with reduced physical, sensory or mental capabilities, or lack of experience and knowledge, unless they have been given supervision or instruction concerning use of the appliance by a person responsible for their safety. Children should be supervised to ensure that they do not play with the appliance.
- If the quick-dry nozzle or hair dryer is damaged, stop using it.
- Do not use the hair dryer for purposes other than drying and styling human hair.
- Do not use any attachments with this dryer other than those supplied by Panasonic.
- Be careful of how you point the hair dryer and do not get the air inlet too close to your hair.**

• **Keep your hair over 10 cm away from the air inlet during use.**

* Failure to do so may result in your hair becoming sucked in and trapped in the hair dryer. (Fig. 1)

• **Please keep a distance of over 3 cm between the air outlet and your hair. (Fig. 2)**

* Failure to do so may result in your hair being burned.

• Please keep the instructions well.



(Fig. 1)



(Fig. 2)

How to use the hair dryer

1 Select the intensity of the airflow with the main switch.

● **Notes**

• Before using the hair dryer, first set the main switch to position "0", then plug into a power outlet and turn on the main switch.

• If you want to dry your hair quickly, set the quick-dry nozzle in the direction shown in the illustration.



How to store the hair dryer

Place the dryer on the stand with the handle folded and quick-dry nozzle still mounted.

• Do not place the dryer on the stand with the power on.

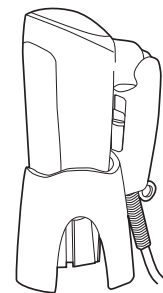

Repair and maintenance of the hair dryer

- Only qualified personnel should repair or disassemble the hair dryer.
- If the cord is damaged, it must be replaced by the manufacturer, its service agent, or similarly qualified persons in order to avoid a hazard.
- If air frequently becomes cold when using hot air, or sparks are sometimes seen inside the hair dryer, please seek advice or contact an authorized Panasonic service center for repair.

● Maintenance of air outlet and air inlet (once a month or more)

- To clean the air outlet, set the main switch to "1", and rake out with a brush while cool air is blowing out.
- To clean the air inlet, set the main switch to "0" and, with the airflow stopped, remove dust and hairs using a brush or vacuum cleaner.
- Be careful since dust may spray out.
- When dust clogs the mesh, the thermostat switch will operate, frequently switching to cool airflow and reducing the drying/set performance.
- The thermostat switch is a protective device. Sparks may be seen during operation but these do not present any danger.

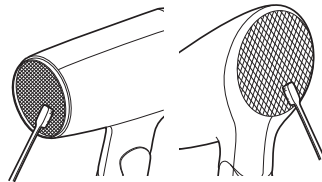

Specifications

Product name		Hair Dryer
Product model		EH-ND32/EH-ND21
Power source		220V ~ 50Hz
Power consumption		1200W
Dimensions		73 (W) × 172 (D) × 202 (H) mm
Accessory	EH-ND32	Quick-dry nozzle, Stand
	EH-ND21	Quick-dry nozzle
Place of origin		China
Date of production		See engraving on the commodity.
Execution Standard	Chinese standard	GB4706.1 GB4706.15 GB4343.1 GB17625.1
	Company standard	Q/SXDGWB 7

This product is intended for household use only.

CAUTION!

Failure to follow these safeguards could result in injury to fingers.

When extending the handle

DO NOT TOUCH the shaded area in the diagram below when holding the handle or using the hair dryer.

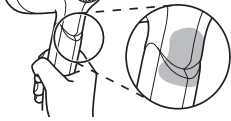

When folding the handle

DO NOT TOUCH the shaded area in the diagram below when folding the handle.

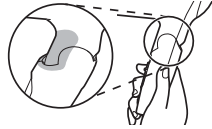

保修证

保修条款

有关保修期内Panasonic商品的保修（无偿修理），从购入之日起开始实施。

1. 保修期内的商品只可在Panasonic认定维修店进行保修；保修时，请出示本保修证及购机发票。
以下两点需特别注意：

- a. 本保修证遗失后不再补发，请妥善保管。
 - b. 本保修证仅限于中华人民共和国内有效(香港、澳门、台湾三地区暂不可使用)。
2. 自购入之日起在以下期间内，在正常使用中发生故障的情况下进行保修。

- 整机（除商用产品）.....2年内无偿
- 整机（商用产品）.....6个月
- 内刀头、外刀网、刀头、辅助装置、附件.....有偿提供

3. 属下列情况之一者，即使在保修期内，也不能以保修对待，但是可以实行收费修理：

- a. 未按商品使用说明书要求使用、维护、保管而造成损坏的；
- b. 因不正确操作、电源不正常、破损（如：摔落等）而造成损坏的；
- c. 不经Panasonic认定维修店维修人员拆卸造成损坏的；
- d. 不能出示本保修证及有效购机发票的；
- e. 保修证上记录的信息与商品实物标识不符或者涂改的；
- f. 因不可抗力因素（如雷电、地震、火灾、水灾等）造成损坏的。

4. 本保修条款只适用于消费者个人为生活消费需要而购买使用的场合，不适用于经营性使用。

【商品信息】

商品名称: **电吹风** 产地: 中国·广州

商品型号: EH-ND32/EH-ND21 制造编号:

【保修回执】 以下回执是保修的重要依据，请勿自行撕下

保修结算 4

商品型号: EH-ND32/EH-ND21 制造编号:

保修结算 3

商品型号: EH-ND32/EH-ND21 制造编号:

保修结算 2

商品型号: EH-ND32/EH-ND21 制造编号:

保修结算 1

商品型号: EH-ND32/EH-ND21 制造编号:

促销员留存

商品型号: EH-ND32/EH-ND21 制造编号:

保修证管理编码印刷处：

本保修证内容如有变更恕不另行通知

[销售记录] 不完整记录以下信息将无法进行保修

销售日期：_____ 发票号码：_____

安装调试日期：_____

销售店
(盖章)

顾客姓名：_____ 联系电话：_____

邮 编：_____

顾客地址：_____

邮 编：_____

销售店名称：_____ 销售店电话：_____

邮 编：_____

销售店地址：_____

邮 编：_____

[维修记录]

维修店名称：_____ 联系电话：_____

送修日：_____

维修店地址：_____

邮 编：_____

故障内容：_____

故障原因：_____

维修内容：_____

交验日期：_____

维修员签字：_____

交验日期：_____

维修店名称：_____ 联系电话：_____

送修日：_____

维修店地址：_____

邮 编：_____

故障内容：_____

故障原因：_____

维修内容：_____

交验日期：_____

维修员签字：_____

交验日期：_____

维修店名称：_____ 联系电话：_____

送修日：_____

维修店地址：_____

邮 编：_____

故障内容：_____

故障原因：_____

维修内容：_____

交验日期：_____

维修员签字：_____

交验日期：_____

Panasonic客户咨询服务中心：
400-810-0781；800-810-0781 (固定电话)
Panasonic官方网站：<http://panasonic.cn>

松下电器(中国)有限公司

松下电工 • 万宝电器(广州)有限公司 (PEWWBG)
Panasonic Electric Works Wanbao (Guangzhou) Co., Ltd.

工厂地址: 广州市番禺区市广路万宝基地
(Address): Wanbao Base, Shiguang Road,
Panyu District, Guangzhou

电话(Tel): (020)84770333

传真(Fax): (020)84773033

邮政编码(Post Code): 511495

原产地: 中国

中国印刷
Printed in China
EH921ND32211 S0810-0
发行: 2010年8月

© CH, EN