



imageCLASS

MF913w / MF912

User's Guide

Contents

Setting Up	2
Main Functions	3
Preparations Required Before Use	4
Preventing Unauthorized Access	5
Setting Up Using the Setup Guide	7
Setting the Date/Time	9
Setting Up the Network Environment	11
Selecting Wired LAN or Wireless LAN	13
Connecting to a Wired LAN	14
Connecting to a Wireless LAN	15
Setting Up Connection Using WPS Push Button Mode	17
Setting Up Connection Using WPS PIN Code Mode	19
Setting Up Connection by Selecting a Wireless Router	21
Setting Up Connection by Specifying Detailed Settings	23
Checking the SSID and Network Key	26
Setting IP Addresses	27
Setting IPv4 Address	28
Setting IPv6 Addresses	31
Viewing Network Settings	34
Configuring Settings for Communication with a Computer	36
Configuring Printing Protocols and WSD Functions	37
Configuring Printer Ports	39
Setting Up Print Server	43
Configuring the Machine for Your Network Environment	46
Configuring Ethernet Settings	47
Changing the Maximum Transmission Unit	49
Setting a Wait Time for Connecting to a Network	50
Configuring DNS	51
Monitoring and Controlling the Machine with SNMP	54
Configuring SNTP	58
Installing Drivers	60
Configuring Scan Settings	61
Preparing to Use the Machine as a Scanner	62
Basic Operations	64
Parts and Their Functions	67
Front Side	68
Back Side	70
Drawer	71
Operation Panel	72
Turning ON the Machine	74
Turning OFF the Machine	75

Using the Operation Panel	76
Basic Screens	77
Home Screen	78
<Status Monitor> Screen	79
Message Display	80
Basic Operation	81
Entering Text	83
Placing Originals	84
Loading Paper	86
Loading Paper in the Drawer	88
Loading Envelopes	92
Loading Preprinted Paper	94
Specifying Paper Size and Type	95
Specifying Paper Size and Type in the Drawer	96
Registering a Custom Paper Size	97
Limiting the Paper Sizes Displayed	98
Customizing the Display	99
Customizing the Home Screen	100
Changing the Default Settings for Functions	101
Entering Sleep Mode	102

Copying 104

Basic Copy Operations	105
Canceling Copies	108
Checking the Copying Status	109
Enhancing and Adjusting Copy Quality	110
Selecting the Type of Original for Copying	111
Adjusting Sharpness for Copying (Sharpness)	112
Useful Copy Functions	113
Copying Multiple Documents onto One Sheet (N on 1)	114
Collating Copies by Page	115
Making ID Card Copies	116

Printing 118

Printing from a Computer	119
Canceling Prints	121
Checking the Printing Status and Log	123

Scanning 126

Basic Operations for Scanning Originals	127
Scanning and Saving to a Computer	128
Scanning Using the Shortcut Key	130
Canceling Sending Documents	133
Using Your Computer to Scan (Remote Scan)	134

Scanning Documents from an Application	135
Using ScanGear MF	137

Linking with Mobile Devices 139

Connecting with Mobile Devices	140
Connecting via a Wireless LAN Router (LAN Connection)	141
Connecting Directly (Access Point Mode)	142
Utilizing the Machine through Applications	145
Using AirPrint	146
Printing with AirPrint	151
Scanning with AirPrint	154
If AirPrint Cannot Be Used	156
Using Google Cloud Print	157
Managing the Machine by the Remote Control	159

Managing the Machine 161

Setting Access Privileges	163
Setting the System Manager PIN	164
Setting a Remote UI PIN	166
Configuring the Network Security Settings	168
Restricting Communication by Using Firewalls	170
Specifying IP Addresses for Firewall Settings	171
Specifying MAC Addresses for Firewall Settings	174
Changing Port Numbers	176
Setting a Proxy	177
Configuring the Key and Certificate for TLS	179
Generating the Key and Certificate for Network Communication	181
Generating a Key and Certificate Signing Request (CSR)	184
Registering the Key and Certificate for Network Communication	187
Configuring IEEE 802.1X Authentication Settings	189
Restricting the Machine's Functions	193
Restricting USB Functions	194
Disabling HTTP Communication	195
Disabling Remote UI	196
Managing the Machine from a Computer (Remote UI)	197
Starting Remote UI	198
Checking the Status and Logs	201
Setting Up Menu Options from Remote UI	205
Updating the Firmware	208
Initializing Settings	210

Setting Menu List 213

<Network Settings>	214
<Preferences>	223

<Timer Settings>	227
<Copy Settings>	231
<Scan Settings>	233
<Printer Settings>	234
<Adjustment/Maintenance>	236
<System Management Settings>	241

Maintenance 249

Regular Cleaning	251
Cleaning the Exterior	252
Cleaning the Platen Glass	253
Cleaning the Fixing Assembly	254
Replacing the Toner Cartridge	255
Replacing the Drum Cartridge	258
Checking the Remaining Amount of Consumables	262
Relocating the Machine	263
Viewing the Counter Value	265
Printing Reports and Lists	266
Consumables	268

Troubleshooting 272

Common Problems	274
Installation/Settings Problems	275
Copying/Printing Problems	279
When You Cannot Print Properly	282
Printing Results Are Not Satisfactory	284
Paper Creases or Curls	292
Paper Is Fed Incorrectly	294
A Message or a Number Starting with "#" (an Error Code) Is Displayed	295
Countermeasures for Each Message	296
Countermeasures for Each Error Code	305
Clearing Paper Jams	306
Paper Jams inside the Machine	307
When a Problem Cannot Be Solved	310

Appendix 312

Third Party Software	313
Feature Highlights	314
Going Green and Saving Money	315
Improving Efficiency	316
Going Digital	317
So Much More	319
Specifications	321
Main Unit	322

Available Paper	325
Scan Function	327
Printer Functions	328
Management Functions	329
System Environment	330
Network Environment	331
Manuals and Their Contents	332
Using User's Guide	333
Screen Layout of User's Guide	334
Viewing User's Guide	337
Basic Windows Operations	338
Notice	346

Setting Up

Setting Up	2
Main Functions	3
Preparations Required Before Use	4
Preventing Unauthorized Access	5
Setting Up Using the Setup Guide	7
Setting the Date/Time	9
Setting Up the Network Environment	11
Selecting Wired LAN or Wireless LAN	13
Connecting to a Wired LAN	14
Connecting to a Wireless LAN	15
Setting Up Connection Using WPS Push Button Mode	17
Setting Up Connection Using WPS PIN Code Mode	19
Setting Up Connection by Selecting a Wireless Router	21
Setting Up Connection by Specifying Detailed Settings	23
Checking the SSID and Network Key	26
Setting IP Addresses	27
Setting IPv4 Address	28
Setting IPv6 Addresses	31
Viewing Network Settings	34
Configuring Settings for Communication with a Computer	36
Configuring Printing Protocols and WSD Functions	37
Configuring Printer Ports	39
Setting Up Print Server	43
Configuring the Machine for Your Network Environment	46
Configuring Ethernet Settings	47
Changing the Maximum Transmission Unit	49
Setting a Wait Time for Connecting to a Network	50
Configuring DNS	51
Monitoring and Controlling the Machine with SNMP	54
Configuring SNTP	58
Installing Drivers	60
Configuring Scan Settings	61
Preparing to Use the Machine as a Scanner	62

Setting Up

38CS-000

Before using the functions of the machine, the environmental conditions must be set in advance. To begin with, check the sequences of flow required to complete the setup, and then perform the actual settings. **▶Preparations Required Before Use(P. 4)**

NOTE

- The functions installed on the machine vary depending on the model you purchased. Before using the machine, see **▶Main Functions(P. 3)** and check the available functions.

Configuring Initial Settings of the Machine (Setup Guide)

- You can easily configure the initial settings required to use the machine, such as date, time, and network settings, by following the on-screen guidance. **▶Setting Up Using the Setup Guide(P. 7)**

Main Functions

This manual covers all the functions of the model series you purchased. Before getting started, check which functions are available on the model you purchased.

✓ : With function — : Without function

Function	MF913w	MF912
Copy	✓	✓
Print	✓	✓
Fax	—	—
Scan	✓	✓
2-sided printing	—	—
Wired LAN connection	✓	—
Wireless LAN connection	✓	—
Remote UI	✓	—
Keys and Certificates	✓	—
Linking with Mobile Devices	✓	—

NOTE

- For the available driver types, see the CD-ROM/DVD-ROM supplied with the machine, or see the Canon website (<http://www.canon.com/>).

LINKS

🔗 [Viewing User's Guide\(P. 337\)](#)

Preparations Required Before Use

38CS-002

Set up the machine following steps 1 to 4 in order. For more information about a particular step, click on the link to go to the corresponding section. In addition, to use the machine safely, also check **▶Preventing Unauthorized Access(P. 5)** .

Step 1 ▶Setting Up Using the Setup Guide(P. 7)



Step 2 ▶Setting Up the Network Environment(P. 11)

- Configure the network settings that are not covered in the Setup Guide. If you do not need to use the Setup Guide, configure the network settings from here.



Step 3 ▶Installing Drivers(P. 60)



Step 4 ▶Configuring Scan Settings(P. 61)



TIPS

Setting from the Remote UI

- When the network environment settings are complete, you can efficiently set the machine from a computer using Remote UI. **▶Starting Remote UI(P. 198)**

Preventing Unauthorized Access

38CS-003

This section describes the security measures on how to prevent unauthorized access from the external network. This is a must-read for all users and administrators before using this machine, other printers, and multifunction machines connected to the network. In recent years, a printer/multifunction machine connected to the network can offer you a variety of useful functions, such as printing from a computer, operating from a computer using the remote function, and sending scanned documents via the Internet. On the other hand, it is essential to take security measures to reduce the security risk for information leakage, as a printer/multifunction machine has become more exposed to threats, such as unauthorized access and theft, when it is connected to the network. This section explains necessary settings you need to specify to prevent unauthorized access before using a printer/multifunction machine connected to the network.

Security Measures to Prevent Unauthorized Access from the External Network

- ▶ **Assigning a Private IP Address(P. 5)**
- ▶ **Using Firewall to Restrict Transmission(P. 6)**
- ▶ **Specifying the TLS Encrypted Communication (P. 6)**
- ▶ **Setting PIN to Manage Information Stored in the Machine(P. 6)**

Assigning a Private IP Address

An IP address is a numerical label assigned to each device participating in a computer network. A "global IP address" is used for the communication connecting to the Internet, and a "private IP address" is used for the communication within a local area network, such as a LAN in the company. If a global IP address is assigned, your printer/multifunction machine is open to the public and can be accessed via the Internet. Thus, the risk of information leakage due to unauthorized access from external network increases. On the other hand, if a private IP address is assigned, your printer/multifunction machine is closed to a local area network and can be accessed by only users on your local area network, such as a LAN in the company.

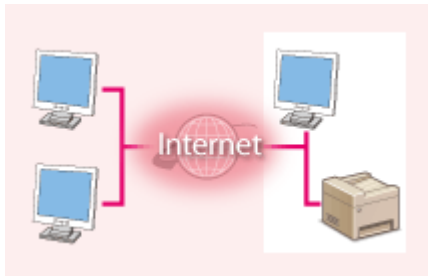

Global IP Address

Can be accessed from the external network

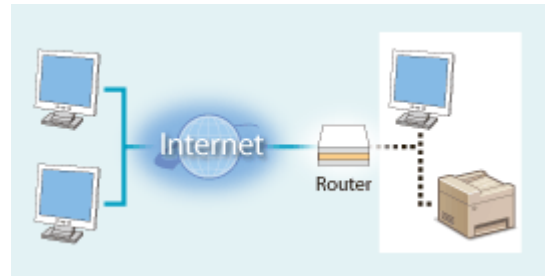

Private IP Address

Can be accessed from the users within a local area network

Basically, assign a private IP address to your printer/multifunction machine. Make sure to confirm the IP address, assigned to the printer/multifunction machine you are using, is a private IP address or not. A private IP address is found in one of the following ranges.

■ Ranges for Private IP addresses

- From 10.0.0.0 to 10.255.255.255
- From 172.16.0.0 to 172.31.255.255
- From 192.168.0.0 to 192.168.255.255

For information on how to confirm the IP address, see ▶ **Setting IPv4 Address(P. 28)** .

NOTE

- If a global IP address is assigned to a printer/multifunction machine, you can create a network environment to reduce the risk of unauthorized access by installing security software, such as a firewall that prevents

access from the external networks. If you want to assign a global IP address to and use a printer/multifunction machine, contact your network administrator.

Using Firewall to Restrict Transmission

A firewall is a system that prevents unauthorized access from the external networks and protects against attacks/intrusions to a local area network. You can use a firewall on your network environment to block access from the external network that appears to be dangerous, by restricting communication from specified IP address of the external network. The function installed to a Canon printer/multifunction machine enables you to set up the IP address filter. For information on how to set up an IP address filter, see [▶Specifying IP Addresses for Firewall Settings\(P. 171\)](#) .

Specifying the TLS Encrypted Communication

For information on the TLS Encrypted Communication, see [▶Configuring the Network Security Settings\(P. 168\)](#) , and on the procedures to specify, see [▶Configuring the Key and Certificate for TLS\(P. 179\)](#) .

Setting PIN to Manage Information Stored in the Machine

If a malicious third party attempts to gain unauthorized access to a printer/multifunction machine, setting PIN to information stored in the machine will reduce the risk of information leakage. Canon printers/multifunction machines enable you to protect various type of information by setting PIN.

■Setting PIN to Each Function

- Setting PIN for Using Remote UI
For more information, see [▶Setting a Remote UI PIN\(P. 166\)](#) .
- Setting PIN for the System Manager Settings
For more information, see [▶Setting the System Manager PIN\(P. 164\)](#) .

Listed above are some examples of security measures for preventing unauthorized access. For more information on the other security measures, see [▶Managing the Machine\(P. 161\)](#) and take necessary security measures for preventing unauthorized access to suit your environment.

Setting Up Using the Setup Guide

38CS-004

When the machine is turned on (**Turning ON the Machine(P. 74)**) for the first time, the Setup Guide starts up to assist you to configure the initial settings of the machine by following the on-screen guidance. In the Setup Guide, the setting screens are displayed in the following order.

Step 1

Setting the Display Language and the Country or Region

Set the language to be displayed on the operation panel screen or in reports, as well as the country or region where the machine will be used.

- 1 Select a language.
- 2 Select a country or region.

Step 2

Setting the Date and Time

Adjust the machine's date/time.

- 1 Select a time zone.

NOTE:

What is UTC?

- Coordinated Universal Time (UTC) is the primary time standard by which the world regulates clocks and time. The correct UTC time zone setting is required for Internet communications.

- 2 Enter the date and time, and press **OK**.

Step 3

Setting the Access Security Measures

Set a PIN to access the Remote UI. Because the Remote UI can be used to change the machine settings from a computer, setting of a PIN is recommended.

- 1 Select <Yes>.
 - If you select <No>, PIN is not set, and the Setup Guide proceeds to step 4.
 - You can also set the access security measure of the Remote UI later.
 - **Setting a Remote UI PIN(P. 166)**
- 2 Enter the PIN, and then select <Apply>.
- 3 Enter the same PIN, and then select <Apply>.

Step 4

Setting the Wireless LAN

Configure the settings to connect to the network using the wireless LAN.

- 1 Select <Yes>.
 - Select <No> to finish the Setup Guide without configuring the wireless LAN settings. Read the displayed message, and press **OK**.
- 2 Select <OK>.
- 3 Select the setting method.
 - For more information about the wireless LAN settings, see **Connecting to a Wireless LAN(P. 15)**.

- 4 Read the message that is displayed, and press **OK**.

⇒ When the Setup Guide is complete, the Home screen appears.

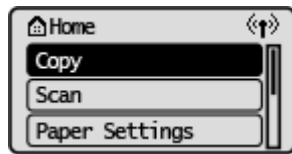

Setting the Date/Time

38CS-005

Set the date and time for the machine. The date and time are used as the reference for the functions specifying the time, therefore, they need to be set accurately.

- ▶ **Setting the Time Zone(P. 9)**
- ▶ **Setting the Current Date and Time(P. 9)**
- ▶ **Setting the Daylight Saving Time(P. 10)**

Setting the Time Zone

If the time zone setting is changed, the values set in <Current Date/Time Settings> are also changed accordingly.

- 1** Select <Menu> in the Home screen. ▶ **Home Screen(P. 78)**
- 2** Select <Timer Settings> ▶ <Date/Time Settings> ▶ <Time Zone>.
- 3** Select the time zone.

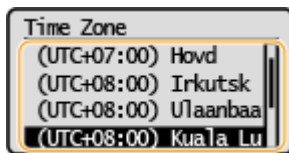

NOTE

What is UTC?

- Coordinated Universal Time (UTC) is the primary time standard by which the world regulates clocks and time. Time differences exist depending on the country or area where the machine is used. The correct UTC time zone setting is required for Internet communications.

Setting the Current Date and Time

- 1** Select <Menu> in the Home screen. ▶ **Home Screen(P. 78)**
- 2** Select <Timer Settings> ▶ <Date/Time Settings> ▶ <Current Date/Time Settings>.
- 3** Enter the date and time.
 - Use ◀ or ▶ to move the cursor, and enter the date and time using ▲ or ▼.

4 Press .**IMPORTANT**

- Set <Time Zone> before setting the current date and time. If the <Time Zone> setting is changed later, the current date and time are also changed accordingly.

NOTE

- The display format of the date and time can be changed, respectively.
 - ▶ <Date Format>(P. 227)
 - ▶ <Time Format>(P. 227)

Setting the Daylight Saving Time

If daylight saving time is enabled, specify the dates from which and to which daylight saving time is in effect.

- 1** Select <Menu> in the Home screen. ▶ Home Screen(P. 78)
- 2** Select <Timer Settings> ▶ <Date/Time Settings> ▶ <Daylight Saving Time Settings>.
- 3** Select <Off> or <On> in <Daylight Saving Time>.
 - When you select <On>, proceed to step 4.
- 4** Set the month and day for the start date, and then select <Apply>.
 - To set the day, specify "what day of which week."
- 5** Set the month and day for the end date, and then select <Apply>.
 - To set the day, specify "what day of which week."

NOTE

- This setting may be unavailable depending on the country or region of purchase.

Setting Up the Network Environment

38CS-006

When connecting the machine to a wired or wireless local area network (LAN), you need to set an IP address unique to the selected network. Select "wired" or "wireless" depending on your communication environment and networking devices. For specific IP address settings, contact your Internet service provider or Network Administrator.

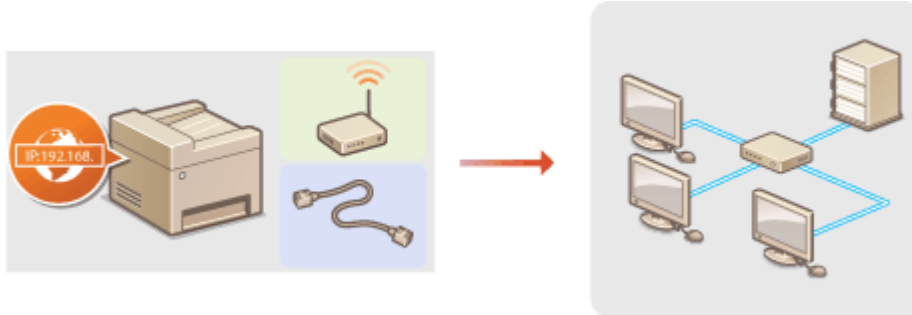

IMPORTANT

- If the machine is connected to an unsecured network, your personal information might be leaked to a third party.

NOTE

- The machine cannot connect to both wired and wireless LANs at the same time.
- The machine does not come with a LAN cable or router. Have them ready as necessary.
- For more information about your networking devices, see the instruction manuals for the devices or contact your manufacturer.

■ Before You Start

Follow these steps to connect the machine to a network.



Check your computer settings.

- Make sure that the computer is correctly connected to the network. For more information, see the instruction manuals for the devices you are using, or contact the device manufacturers.
- Make sure that the network settings have been completed on the computer. If the network has not been set up properly, you will not be able to use the machine on the network, even if you perform the rest of the procedure below.

NOTE:

- Depending on the network, you may need to change settings for the communication method or the Ethernet type ([▶Configuring Ethernet Settings\(P. 47\)](#)). For more information, contact your Internet service provider or Network Administrator.
- To check the MAC address of the machine.
 - ▶[Viewing the MAC Address for Wired LAN\(P. 34\)](#)
 - ▶[Viewing the MAC Address and Information for Wireless LAN\(P. 35\)](#)

- To connect to an IEEE 802.1X network, see [▶Configuring IEEE 802.1X Authentication Settings\(P. 189\)](#) .



2



Select wired or wireless LAN.

- ▶[Selecting Wired LAN or Wireless LAN\(P. 13\)](#)



3



Connect to a wired or wireless LAN.

- Proceed to the section that corresponds to the setting you selected in step 2.
 - ▶[Connecting to a Wired LAN\(P. 14\)](#)
 - ▶[Connecting to a Wireless LAN\(P. 15\)](#)



4



Set the IP address as necessary.

- At the time of purchase, the machine is set to automatically acquire an IP address. Change this setting if you want to use a specific IP address. ▶[Setting IP Addresses\(P. 27\)](#)

LINKS

- ▶[Configuring Settings for Communication with a Computer\(P. 36\)](#)
- ▶[Configuring the Machine for Your Network Environment\(P. 46\)](#)

Selecting Wired LAN or Wireless LAN

38CS-007

After you decide on wired or wireless LAN to connect the machine to the computer, select wired LAN or wireless LAN using the operation panel. Note that if you change the setting from <Wired LAN> to <Wireless LAN> or vice versa, you will need to uninstall the drivers installed on your computer and then reinstall them. For more information, see the manuals for the relevant drivers on the online manual website.

1 Select <Menu> in the Home screen.  **Home Screen(P. 78)**

2 Select <Network Settings>.

- If the screen for entering a PIN appears, enter the correct PIN.  **Setting the System Manager PIN(P. 164)**

3 Select <Select Wired/Wireless LAN>.

4 Select <Wired LAN> or <Wireless LAN>.

LINKS

-  **Setting Up the Network Environment(P. 11)**
-  **Connecting to a Wired LAN(P. 14)**
-  **Connecting to a Wireless LAN(P. 15)**

Connecting to a Wired LAN

38CS-008

Connect the machine to a computer via a router. Use a LAN cable to connect the machine to the router.

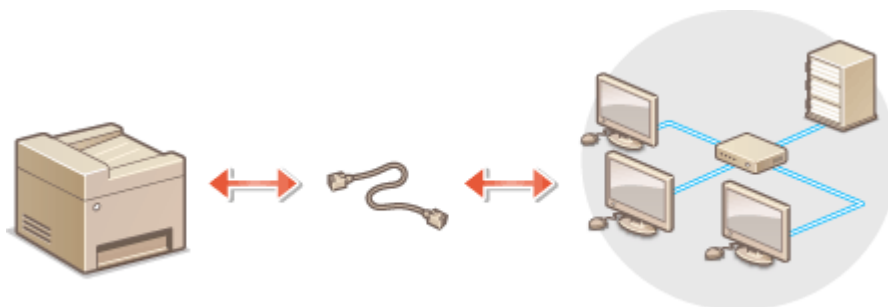

1 Connect a LAN cable.

- Connect the machine to a router by using a LAN cable.
- Push the connector in until it clicks into place.

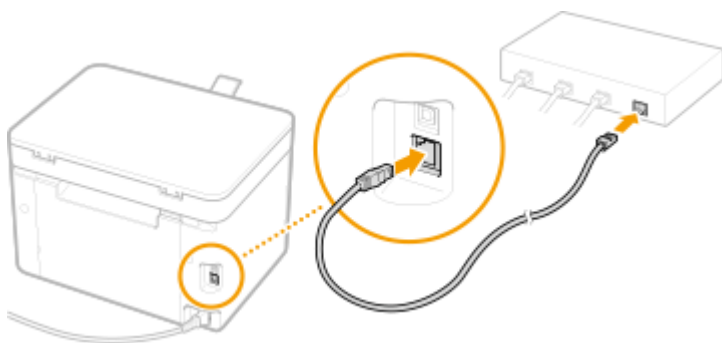

2 Wait for several minutes.

⇒ The IP address is set automatically.

NOTE:

- You can set the IP address manually. [▶Setting IP Addresses\(P. 27\)](#)

LINKS

[▶Setting Up the Network Environment\(P. 11\)](#)

Connecting to a Wireless LAN

38CS-009

Wireless routers (or access points) connect the machine to a computer via radio waves. If your wireless router is equipped with Wi-Fi Protected Setup (WPS), configuring your network is automatic and easy. If your networking devices do not support automatic configuration, or if you want to specify authentication and encryption settings in detail, you need to manually set up the connection. Make sure that your computer is correctly connected to the network.

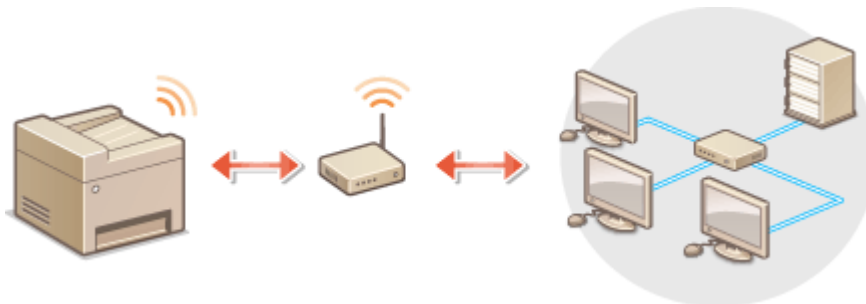

▶ **Setting Up Connection Using WPS(P. 15)**

▶ **Manually Setting Up Connection(P. 16)**

IMPORTANT

Risk of information leak

- Use wireless LAN connection at your own discretion and at your own risk. If the machine is connected to an unsecured network, your personal information might be leaked to a third party because radio waves used in wireless communication can go anywhere nearby, even beyond walls.

Wireless LAN security

- The wireless LAN function of this machine supports WEP, WPA-PSK, and WPA2-PSK. For the wireless security compatibility of your wireless router, see the instruction manuals for your networking devices or contact your manufacturer.

NOTE

Required devices for wireless LAN connection

- The machine does not come with a wireless router. Have the router ready as necessary.

Setting Up Connection Using WPS

When using WPS, two modes are available: push button mode and PIN code mode.

■ Push Button Mode

Find the WPS mark shown below on the package of your wireless router. Also make sure that there is a WPS button on your networking device. ▶ **Setting Up Connection Using WPS Push Button Mode(P. 17)**



■ PIN Code Mode

Some WPS routers do not support the push button mode. If WPS PIN code mode is mentioned on the package or in the instruction manuals of your networking device, set up the connection by entering the PIN code. [▶Setting Up Connection Using WPS PIN Code Mode\(P. 19\)](#)

NOTE

- If the wireless router is set to use WEP authentication, you may not be able to set up connection using WPS.

Manually Setting Up Connection

When manually setting up a wireless connection, you can either select a wireless router or manually enter the required information. Regardless of the method, make sure that you have the required setup information, including the SSID and network key. [▶Checking the SSID and Network Key\(P. 26\)](#)

■ Selecting a Wireless Router

Select this setup option if you need to manually set up the connection but want to complete the setup as easily as possible. [▶Setting Up Connection by Selecting a Wireless Router\(P. 21\)](#)

■ Manually Entering the Setup Information

If you want to specify security settings in detail, such as authentication and encryption settings, manually enter the SSID and network key to set up the connection. [▶Setting Up Connection by Specifying Detailed Settings\(P. 23\)](#)

LINKS

[▶Setting Up the Network Environment\(P. 11\)](#)

[▶Selecting Wired LAN or Wireless LAN\(P. 13\)](#)

Setting Up Connection Using WPS Push Button Mode

38CS-00A

If your wireless router supports WPS push button mode, you can easily set up a connection with a WPS button.

IMPORTANT

- How to operate the wireless router may vary on each device. See the instruction manuals for your networking device for help.

1 Select <Menu> in the Home screen. ▶Home Screen(P. 78)

2 Select <Network Settings>.

- If the screen for entering a PIN appears, enter the correct PIN. ▶Setting the System Manager PIN(P. 164)

3 Select <Wireless LAN Settings>.

- If the <Enable the wireless LAN?> message is displayed, select <Yes>.
- If the <Direct Connection will be disabled. Is it OK?> message is displayed, select <Yes>.

4 Read the message that is displayed, and select <OK>.

5 Select <WPS Push Button Mode>.

6 Select <Yes>.

7 Press and hold the WPS button on the wireless router.

- The button must be pressed within 2 minutes after selecting <Yes> in step 6.
- Depending on the networking device, you may need to press and hold the button for 2 seconds or longer. See the instruction manuals for your networking device for help.

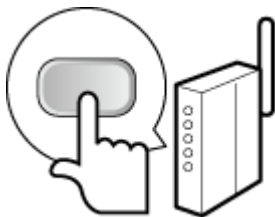

NOTE:

If an error message is displayed during setup

- Select <Close> and return to step 5.

8 Wait until message <Connected.> is displayed.

Wait several minutes until the IP address and other items are set automatically.

IMPORTANT:

Signal strength

- When more than one wireless router is available for connection, the machine connects to the device with the strongest signal. Signal strength is measured using RSSI (Received Signal Strength Indication).

NOTE:

- You can set the IP address manually. [▶Setting IP Addresses\(P. 27\)](#)
- While the machine is connected to the wireless LAN, the Wi-Fi icon is displayed in the Home screen. [▶Home Screen\(P. 78\)](#)

NOTE

Reducing power consumption

- You can set the machine to enter <Power Save Mode> based on signals emitted from the wireless router. [▶<Power Save Mode>\(P. 215\)](#)

If the IP address of the machine has changed

- In a DHCP environment, the IP address of the machine may be changed automatically. If this happens, the connection is maintained as long as the machine and the computer belong to the same subnet.

LINKS

- [▶Connecting to a Wireless LAN\(P. 15\)](#)

Setting Up Connection Using WPS PIN Code Mode

38CS-00C

If your wireless router supports WPS PIN code mode, generate a PIN code with the machine and register the code to the networking device.

IMPORTANT

- How to operate the wireless router may vary on each device. See the instruction manuals for your networking device for help.



From a Computer

1 Access your wireless router from a computer and display the screen for entering a WPS PIN code.

- For more information, see the instruction manuals for your networking device.



From the Operation Panel

2 Select <Menu> in the Home screen. ▶ Home Screen(P. 78)

3 Select <Network Settings>.

- If the screen for entering a PIN appears, enter the correct PIN. ▶ Setting the System Manager PIN(P. 164)

4 Select <Wireless LAN Settings>.

- If the <Enable the wireless LAN?> message is displayed, select <Yes>.
- If the <Direct Connection will be disabled. Is it OK?> message is displayed, select <Yes>.

5 Read the message that is displayed, and select <OK>.

6 Select <WPS PIN Code Mode>.

7 Select <Yes>.

⇒ The PIN code is generated and shown on the display.



From a Computer

8 Register the generated PIN code to the wireless router.

- Register the PIN code on the setup screen displayed in step 1.
- The PIN code must be registered within 10 minutes after selecting <Yes> in step 7.

NOTE:**If an error message is displayed during setup**

- Select <Close> and return to step 6.



From the Operation Panel

9 Wait until the message <Connected.> is displayed.

⇒ Wait several minutes until the IP address and other items are set automatically.

IMPORTANT:**Signal strength**

- When more than one wireless router is available for connection, the machine connects to the device with the strongest signal. Signal strength is measured using RSSI (Received Signal Strength Indication).

NOTE:

- You can set the IP address manually. ▶ **Setting IP Addresses(P. 27)**
- While the machine is connected to the wireless LAN, the Wi-Fi icon is displayed in the Home screen. ▶ **Home Screen(P. 78)**

NOTE**Reducing power consumption**

- You can set the machine to enter <Power Save Mode> based on signals emitted from the wireless router. ▶ **<Power Save Mode>(P. 215)**

If the IP address of the machine has changed

- In a DHCP environment, the IP address of the machine may be changed automatically. If this happens, the connection is maintained as long as the machine and the computer belong to the same subnet.

LINKS

- ▶ **Connecting to a Wireless LAN(P. 15)**

Setting Up Connection by Selecting a Wireless Router

38CS-00E

You can search the wireless routers (or access points) available for connection and select one from the display of the machine. For the network key, enter a WEP key or PSK. Before selecting a wireless router, check and write down the required setup information, including the SSID and network key ([▶Checking the SSID and Network Key\(P. 26\)](#)).

NOTE

Security settings

- If the wireless connection is set up by selecting a wireless router, the WEP authentication method is set to <Open System> or the WPA/WPA2 encryption method is set to <Auto> (AES-CCMP or TKIP). If you want to select <Shared Key> for WEP authentication or <AES-CCMP> for WPA/WPA2 encryption, you need to set up the connection using <Enter Manually>. [▶Setting Up Connection by Specifying Detailed Settings\(P. 23\)](#)

1 Select <Menu> in the Home screen. [▶Home Screen\(P. 78\)](#)

2 Select <Network Settings>.

- If the screen for entering a PIN appears, enter the correct PIN. [▶Setting the System Manager PIN\(P. 164\)](#)

3 Select <Wireless LAN Settings>.

- If the <Enable the wireless LAN?> message is displayed, select <Yes>.
- If the <Direct Connection will be disabled. Is it OK?> message is displayed, select <Yes>.

4 Read the message that is displayed, and select <OK>.

5 Select <SSID Settings>.

6 Select <Select Access Point>.

▢ The machine starts searching for available wireless routers.

NOTE:

- If a message is displayed telling that access point cannot be found, see [▶Countermeasures for Each Message\(P. 296\)](#) .

7 Select a wireless LAN router.

- Select the router whose SSID matches the one that you have written down, and press .

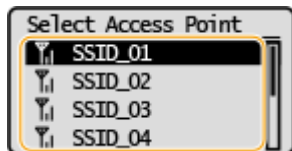
**NOTE:****If your wireless router is not found**

- Check whether the machine is properly installed and ready to connect to the network. ▶ **Installation/Settings Problems(P. 275)**

8 Enter the network key that you have written down.

- Enter the network key, and select <Apply>.
- On how to enter text, see ▶ **Entering Text(P. 83)** .

9 Select <Yes>.**NOTE:****If an error message is displayed during setup**

- Select <Close>, check whether the network key is correct, and return to step 5.

10 Wait until message <Connected.> is displayed.

⇒ Wait several minutes until the IP address and other items are set automatically.

IMPORTANT:**Signal strength**

- When more than one wireless router is available for connection, the machine connects to the device with the strongest signal. Signal strength is measured using RSSI (Received Signal Strength Indication).

NOTE:

- You can set the IP address manually. ▶ **Setting IP Addresses(P. 27)**
- While the machine is connected to the wireless LAN, the Wi-Fi icon is displayed in the Home screen. ▶ **Home Screen(P. 78)**

NOTE**Reducing power consumption**

- You can set the machine to enter <Power Save Mode> based on signals emitted from the wireless router. ▶ **<Power Save Mode>(P. 215)**

If the IP address of the machine has changed

- In a DHCP environment, the IP address of the machine may be changed automatically. If this happens, the connection is maintained as long as the machine and the computer belong to the same subnet.

LINKS

- ▶ **Connecting to a Wireless LAN(P. 15)**

Setting Up Connection by Specifying Detailed Settings

38CS-00F

If you want to specify the security settings in detail or cannot establish the wireless connection using the other procedures, manually enter all the required information for the wireless LAN connection. Before specifying detailed settings, check and write down the required information, including the SSID, network key, and wireless security protocols. [▶Checking the SSID and Network Key\(P. 26\)](#)

1 Select <Menu> in the Home screen. [▶Home Screen\(P. 78\)](#)

2 Select <Network Settings>.

- If the screen for entering a PIN appears, enter the correct PIN. [▶Setting the System Manager PIN\(P. 164\)](#)

3 Select <Wireless LAN Settings>.

- If the <Enable the wireless LAN?> message is displayed, select <Yes>.
- If the <Direct Connection will be disabled. Is it OK?> message is displayed, select <Yes>.

4 Read the message that is displayed, and select <OK>.

5 Select <SSID Settings> ▶ <Enter Manually>.

6 Enter the SSID that you have written down.

- Enter the SSID, and select <Apply>.
- On how to enter text, see [▶Entering Text\(P. 83\)](#) .

7 Specify the security settings based on the information that you have written down.

- If you do not need to specify the security settings, select <None>.

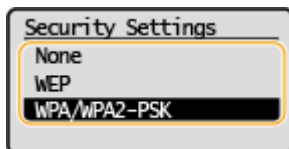

■ Using WEP

- 1 Select <WEP>.
- 2 Select an authentication method.

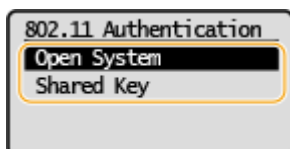

<Open System>

Sets open system authentication, which is also called "open authentication."

<Shared Key>

Uses the WEP key as a password.

NOTE:**When <Open System> is selected**

- When connecting to a wireless LAN, the machine experiences an authentication error if the shared key authentication is set on the wireless router. If this happens, the machine automatically changes the setting to <Shared Key> and retries the connection.

- 3 Select the WEP key you want to edit.
 - Select <Edit WEP Key> ► WEP key (1 to 4).
 - Up to four WEP keys can be registered.
- 4 Enter the network key that you have written down.
 - Enter the network key, and select <Apply>.
- 5 Select the desired WEP key.
 - Select <Select WEP Key> ► select the WEP key you have edited.

■ Using WPA-PSK or WPA2-PSK

- 1 Select <WPA/WPA2-PSK>.
- 2 Select an encryption method.

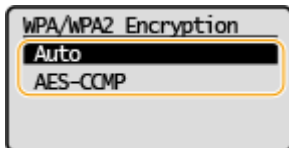
**<Auto>**

Sets the machine to automatically select AES-CCMP or TKIP to match the setting of the wireless router.

<AES-CCMP>

Sets AES-CCMP as the encryption method.

- 3 Enter the network key that you have written down.
 - Enter the network key, and select <Apply>.

8 Select <Yes>.**NOTE:****If an error message is displayed during setup**

- Select <Close>, check whether the specified settings are correct, and return to step 5.

9 Wait until message <Connected.> is displayed.

⇒ Wait several minutes until the IP address and other items are set automatically.

IMPORTANT:

Signal strength

- When more than one wireless router is available for connection, the machine connects to the device with the strongest signal. Signal strength is measured using RSSI (Received Signal Strength Indication).

NOTE:

- You can set the IP address manually. ▶ **Setting IP Addresses(P. 27)**
- While the machine is connected to the wireless LAN, the Wi-Fi icon is displayed in the Home screen. ▶ **Home Screen(P. 78)**

NOTE

Reducing power consumption

- You can set the machine to enter <Power Save Mode> based on signals emitted from the wireless router. ▶ **<Power Save Mode>(P. 215)**

If the IP address of the machine has changed

- In a DHCP environment, the IP address of the machine may be changed automatically. If this happens, the connection is maintained as long as the machine and the computer belong to the same subnet.

LINKS

▶ **Connecting to a Wireless LAN(P. 15)**

Checking the SSID and Network Key

38CS-00H

When manually setting up a wireless connection, you need to specify the SSID and network key of your wireless router. The SSID and network key may be indicated on these networking devices. Check your devices and write down the necessary information before setting up the connection. For more information, see the instruction manuals for your networking devices or contact your manufacturer.

SSID	A name given for identifying a specific wireless LAN. Some other terms used for SSID include "access point name" and "network name."
Network Key	A keyword or password used for encrypting data or authenticating a network. Some other terms used for network key include "encryption key," "WEP key," "WPA/WPA2 passphrase," and "preshared key (PSK)."
Wireless Security Protocols (Authentication/Encryption)	When manually setting up a wireless connection by specifying detailed settings, you need to specify security settings. Check the following information: <ul style="list-style-type: none"> • Security types (WEP/WPA-PSK/WPA2-PSK) • Authentication method (Open System/Shared Key) • Encryption method (TKIP/AES-CCMP)

■ Checking the SSID and Network Key from a Computer

The SSID or the network key may have been changed. If you do not know the SSID or the network key, you can check them by using the "Canon MF/LBP Wireless Setup Assistant." Download the "Canon MF/LBP Wireless Setup Assistant" from the Canon website (<http://www.canon.com/>), and start it up from a computer connected to a wireless LAN.

NOTE

- If no access point is displayed on the screen after startup of the "Canon MF/LBP Wireless Setup Assistant," check if the setup is completed both on the computer and the wireless LAN router.

LINKS

- ▶ **Connecting to a Wireless LAN(P. 15)**
- ▶ **Setting Up Connection by Selecting a Wireless Router(P. 21)**
- ▶ **Setting Up Connection by Specifying Detailed Settings(P. 23)**

Setting IP Addresses

38CS-00J

Connecting the machine to a network requires a unique network IP address. Two versions of IP addresses are available: IPv4 and IPv6. Configure these settings depending on the network environment. To use IPv6 addresses, you need to properly configure the IPv4 address settings.

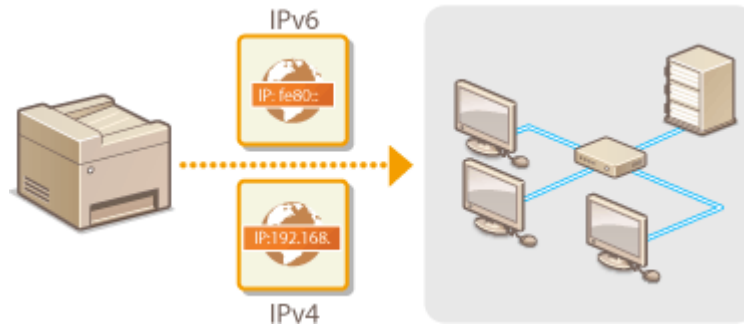

- ▶ [Setting IPv4 Address\(P. 28\)](#)
- ▶ [Setting IPv6 Addresses\(P. 31\)](#)

Setting IPv4 Address

38CS-00K



The machine's IPv4 address can be either assigned automatically by a dynamic IP addressing protocol, such as DHCP, or entered manually. When connecting the machine to a wired LAN, make sure that the connectors of the LAN cable are firmly inserted into the ports (**Connecting to a Wired LAN(P. 14)**). You can test the network connection if necessary.

- ▶ **Setting IPv4 Address(P. 28)**
- ▶ **Testing the Network Connection(P. 29)**

Setting IPv4 Address

- 1** Select **<Menu>** in the Home screen. ▶ **Home Screen(P. 78)**
- 2** Select **<Network Settings>**.
 - If the screen for entering a PIN appears, enter the correct PIN. ▶ **Setting the System Manager PIN(P. 164)**
- 3** Select **<TCP/IP Settings>** ▶ **<IPv4 Settings>** ▶ **<IP Address Settings>**.
- 4** Configure IP address settings.

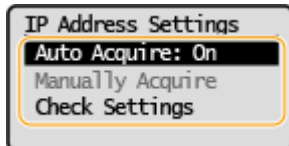

<Auto Acquire>

Select to automatically assign an IP address via DHCP protocol. When **<On>** is displayed, automatic addressing is enabled.

<Manually Acquire>

Select to configure the IP address settings by manually entering an IP address. In order to select this option, the automatic acquirement must be set to **<Off>**.

<Check Settings>

Select when you want to view the current IP address settings.

■ **Automatically assigning an IP address**

- 1** Select **<Auto Acquire>**.
- 2** Select the protocol.
 - Select **<Select Protocol>** ▶ **<DHCP>**.

NOTE:

If you do not want to use DHCP/BOOTP/RARP to assign an IP address

- Select <Off>. If you select <DHCP> when these services are unavailable, the machine will waste time and communications resources searching the network for these services.

- 3 Check that <Auto IP> is set to <On>.
 - If <Off> is selected, change the setting to <On>.

- 4 Select <Apply>.

NOTE:

- IP addresses assigned via DHCP override the address obtained via Auto IP.

■ Manually entering an IP address

- 1 Configure a setting to disable auto-acquisition.
 - Select <Auto Acquire>, and set both <Select Protocol> and <Auto IP> to <Off>.
- 2 Select <Manually Acquire>.
- 3 Specify the IP address, subnet mask, and gateway address (or default gateway).
 - Enter these values in each screen, and select <Apply>.
 - On how to enter text, see [▶ Entering Text\(P. 83\)](#) .

NOTE

Checking whether the settings are correct

- Make sure that the Remote UI screen can be displayed with your computer ([▶ Starting Remote UI\(P. 198\)](#)). If a computer is not available, you can check the connection by using the operation panel ([▶ Testing the Network Connection\(P. 29\)](#)).

When you have changed the IP address after installing the printer driver

- When the MFNP port is used, the connection is maintained as long as the machine and the computer belong to the same subnet; therefore, you do not need to add a new port. When the standard TCP/IP port is used, you need to add a new port. [▶ Configuring Printer Ports\(P. 39\)](#)

*If you do not know which port is used, see [▶ Checking the Printer Port\(P. 342\)](#) .

Testing the Network Connection

- 1 Select <Menu> in the Home screen. [▶ Home Screen\(P. 78\)](#)
- 2 Select <Network Settings>.
 - If the screen for entering a PIN appears, enter the correct PIN. [▶ Setting the System Manager PIN\(P. 164\)](#)
- 3 Select <TCP/IP Settings> ▶ <IPv4 Settings> ▶ <PING Command>.
- 4 Enter the IPv4 address of another device on the network, and select <Apply>.

▢ If a proper connection has been established, <Received response from host.> is displayed.

LINKS

- ▶ **Setting IPv6 Addresses(P. 31)**
- ▶ **Viewing Network Settings(P. 34)**

Setting IPv6 Addresses

38CS-00L



The IPv6 addresses of the machine can be configured via the Remote UI. Before setting IPv6 addresses, check the IPv4 address settings ([▶Viewing IPv4 Settings\(P. 34\)](#)). You need to set the correct IPv4 settings to use IPv6 addresses. Note that the scan function that uses the scanner driver or MF Scan Utility is not available in an IPv6 environment. The machine can use the following multiple IPv6 addresses:

Type	Description
Link-local address	An address that is only valid within a subnet or link and cannot be used to communicate with devices beyond a router. A link-local address is automatically set when the IPv6 function of the machine is enabled.
Manual address	An address that is entered manually. When using this address, specify the prefix length and default router address.
Stateless address	An address that is generated automatically using the MAC address of the machine and the network prefix that is advertised by the router. Stateless addresses are discarded when the machine is restarted (or turned ON).
Stateful address	An address obtained from a DHCP server using DHCPv6.

NOTE

- For more information about the basic operations to be performed when setting the machine from the Remote UI, see [▶Setting Up Menu Options from Remote UI\(P. 205\)](#) .

- 1 Start the Remote UI and log in to System Manager Mode. [▶Starting Remote UI\(P. 198\)](#)**
- 2 Click [Settings/Registration] on the Portal page. [▶Remote UI Screen\(P. 199\)](#)**
- 3 Select [Network Settings] ▶ [TCP/IP Settings].**
- 4 Click [Edit] in [IPv6 Settings].**
- 5 Select the [Use IPv6] check box and configure the required settings.**

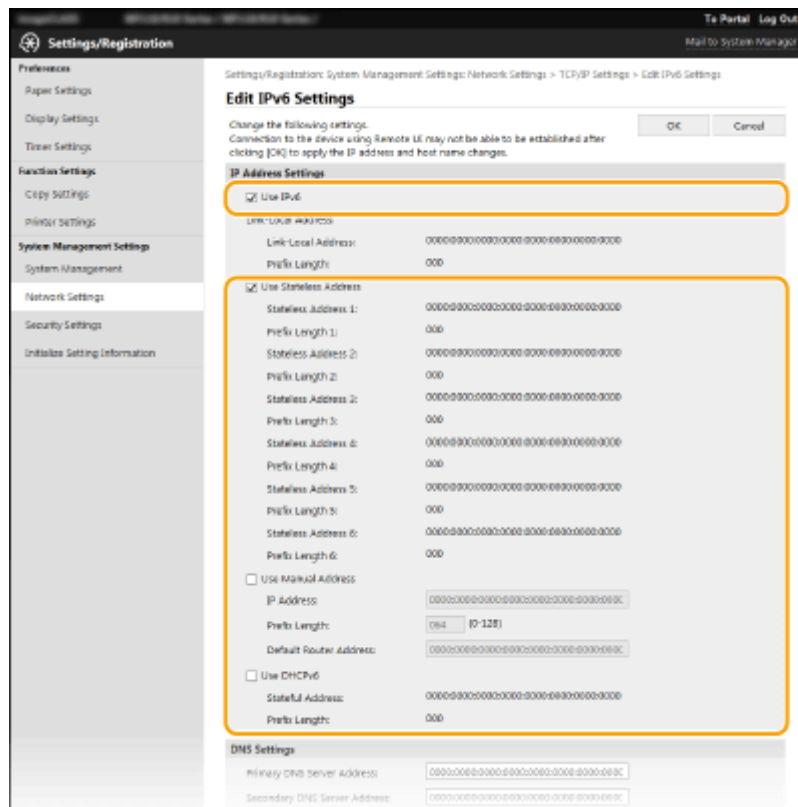
**[Use IPv6]**

Select the check box to enable IPv6 on the machine. When not using IPv6, clear the check box.

[Use Stateless Address]

Select the check box when using a stateless address. When not using a stateless address, clear the check box.

[Use Manual Address]

When you want to manually enter an IPv6 address, select the check box and enter the IP address, prefix length, and default router address in the corresponding text boxes.

[IP Address]

Enter an IPv6 address. Addresses that start with "ff" (or multicast address) and the loopback address (::1) cannot be entered.

[Prefix Length]

Enter a number that indicates how many bits are available for the network address.

[Default Router Address]

Specify the IPv6 address of the default router as necessary. Addresses that start with "ff" (or multicast address) and the loopback address (::1) cannot be entered.

[Use DHCPv6]

Select the check box when using a stateful address. When not using DHCPv6, clear the check box.

6 Click [OK].

NOTE

Checking whether the settings are correct

- Make sure that the Remote UI screen can be displayed with your computer by using the IPv6 address of the machine. [▶Starting Remote UI\(P. 198\)](#)

Selecting settings from the operation panel

- IPv6 settings can also be accessed from <Menu> in the Home screen. [▶<IPv6 Settings>\(P. 218\)](#)

When you have changed the IP address after installing the printer driver

- You need to add a new port. [▶Configuring Printer Ports\(P. 39\)](#)

LINKS

[▶Setting IPv4 Address\(P. 28\)](#)

[▶Viewing Network Settings\(P. 34\)](#)

Viewing Network Settings

38CS-00R

- ▶ Viewing IPv4 Settings(P. 34)
- ▶ Viewing IPv6 Settings(P. 34)
- ▶ Viewing the MAC Address for Wired LAN(P. 34)
- ▶ Viewing the MAC Address and Information for Wireless LAN(P. 35)

NOTE

- The IP address is not correctly configured if it is displayed as "0.0.0.0".
- Connecting the machine to a switching hub or bridge may result in a connection failure even when the IP address is correctly configured. This problem can be solved by setting a certain interval before the machine starts communicating. ▶ **Setting a Wait Time for Connecting to a Network(P. 50)**
- You can print a list of the current network settings. ▶ **User Data List(P. 266)**

Viewing IPv4 Settings



<Status Monitor> ▶ <Network Information> ▶ <IPv4> ▶ Select the setting to view ▶ Check the settings

Viewing IPv6 Settings



<Status Monitor> ▶ <Network Information> ▶ <IPv6> ▶ Select the setting to view ▶ Check the settings

Viewing the MAC Address for Wired LAN

- 1** Select <Menu> in the Home screen. ▶ **Home Screen(P. 78)**
- 2** Select <Network Settings>.
 - If the screen for entering a PIN appears, enter the correct PIN. ▶ **Setting the System Manager PIN(P. 164)**
- 3** Select <Ethernet Driver Settings>.
 - ▣ MAC address is displayed.

Viewing the MAC Address and Information for Wireless LAN

- 1 Select <Menu> in the Home screen. [▶Home Screen\(P. 78\)](#)
- 2 Select <Network Settings>.
 - If the screen for entering a PIN appears, enter the correct PIN. [▶Setting the System Manager PIN\(P. 164\)](#)
- 3 Select <Wireless LAN Settings>.
- 4 Read the message that is displayed, and select <OK>.
- 5 Select <Wireless LAN Information>.
- 6 Select the setting to view.

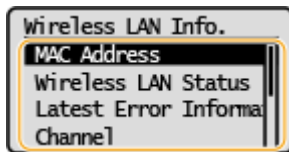

NOTE:

Viewing security information

- To view WEP and WPA/WPA2-PSK information, use the following procedure.
 <Security Settings> ▶ Select the displayed security protocol ▶ Select the setting to view

Viewing from the <Status Monitor> screen

- <Wireless LAN Status> and <Latest Error Information> can be viewed from <Status Monitor>.
 <Status Monitor> ▶ <Network Information> ▶ <Network Connection Method> ▶ <Connection Information> ▶ Select the setting to view

LINKS

- [▶Connecting to a Wireless LAN\(P. 15\)](#)
- [▶Setting IPv4 Address\(P. 28\)](#)
- [▶Setting IPv6 Addresses\(P. 31\)](#)
- [▶Configuring DNS\(P. 51\)](#)

Configuring Settings for Communication with a Computer

38CS-00S

Specify the protocol and port when operating the machine from a computer via the network. Before configuring the machine for printing from a computer, perform the basic setup procedures. For more information, see the manuals for the relevant drivers on the online manual website.

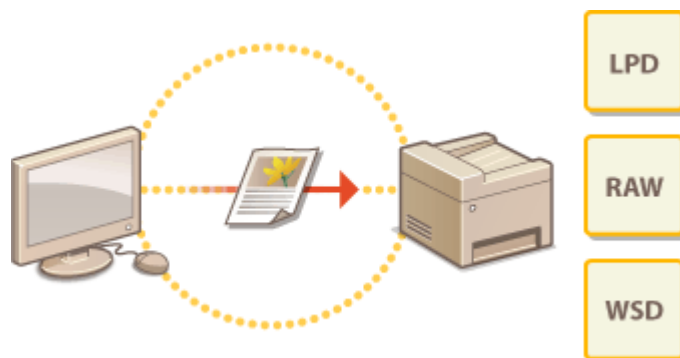

- ▶ [Configuring Printing Protocols and WSD Functions\(P. 37\)](#)
- ▶ [Configuring Printer Ports\(P. 39\)](#)
- ▶ [Setting Up Print Server\(P. 43\)](#)

NOTE

- Protocols explained here are rules for delivering document data between a computer and the machine, and can be selected according to intended purposes or the network environment.
- Ports are gateways for passing data between network devices. If a communication failure occurs in the network connection, the port settings may be the cause of the problem.

Configuring Printing Protocols and WSD Functions

38CS-00U

Configure the protocols that are used for printing documents from a networked computer.

NOTE

- For more information about the basic operations to be performed when setting the machine from the Remote UI, see [▶Setting Up Menu Options from Remote UI\(P. 205\)](#) .

- 1 Start the Remote UI and log in to System Manager Mode.** [▶Starting Remote UI\(P. 198\)](#)
- 2 Click [Settings/Registration] on the Portal page.** [▶Remote UI Screen\(P. 199\)](#)
- 3 Click [Network Settings] ▶ [TCP/IP Settings].**
- 4 Configure printing protocols.**

■Configuring LPD or RAW

- 1 Click [Edit] in [LPD Print Settings] or [RAW Print Settings].
- 2 Configure the settings as necessary.

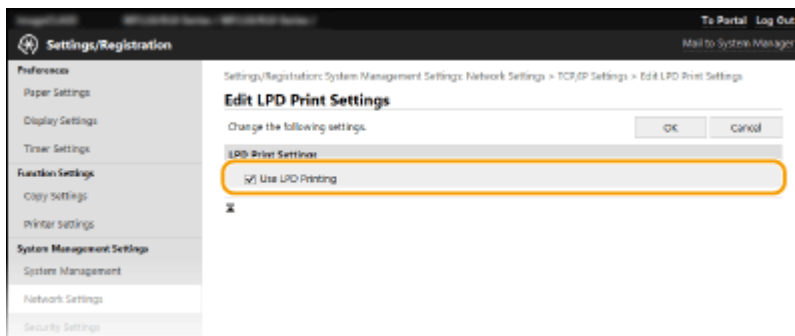

[Use LPD Printing]

Select the check box to print via LPD. When not using LPD printing, clear the check box.

[Use RAW Printing]

Select the check box to print via RAW. When not using RAW printing, clear the check box.

- 3 Click [OK].

■Configuring WSD

- 1 Click [Edit] in [WSD Settings].
- 2 Configure the settings as necessary.

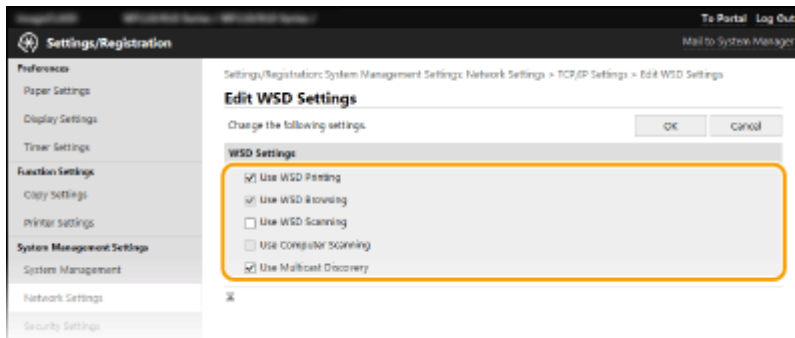

[Use WSD Printing]

Select the check box to print via WSD. When not using WSD printing, clear the check box.

[Use WSD Browsing]

Select the check box to obtain information about the machine from a computer via WSD. This check box is automatically selected when the [Use WSD Printing] check box is selected.

[Use WSD Scanning]

WSD scanning enables you to scan documents to a computer without installing the scanner driver. Select the check box to scan documents via WSD. When not using WSD scanning, clear the check box.

[Use Computer Scanning]

Select the check box to use WSD scanning by operating the machine with the operation panel. This check box can only be selected when the [Use WSD Scanning] check box is selected. To perform scanning, select <Scan> in the Home screen and specify a WSD-connected computer as a scan destination (**▶Scanning and Saving to a Computer(P. 128)**).

[Use Multicast Discovery]

Select the check box to set the machine to reply to multicast discovery messages. If the check box is cleared, the machine stays in sleep mode even when multicast discovery messages are flowing on the network.

3 Click [OK].

NOTE

Selecting settings from the operation panel

- LPD, RAW, and WSD settings can also be accessed from <Menu> in the Home screen.
 - ▶<LPD Print Settings>(P. 219)
 - ▶<RAW Print Settings>(P. 219)
 - ▶<WSD Settings>(P. 219)

Setting up WSD network devices

- The WSD network devices can be added from the printer folder. Open the printer folder (**▶Displaying the Printer Folder(P. 338)**) ▶ click [Add a device] or [Add a printer] and follow the on-screen instructions. For more information about how to install the driver for the WSD network, see the manuals for the relevant drivers on the online manual website.

To change the port number

- The same port number used for the machine and a computer must be used for printing protocol.
 - ▶<Configuring Printer Ports>(P. 39)
 - ▶<Changing Port Numbers>(P. 176)

LINKS

▶<Configuring Printer Ports>(P. 39)

Configuring Printer Ports

38CS-00W

Printing errors can occur when the IP address of the machine has been changed, or when a printer has been added via the Windows printer folder. These errors are typically caused by incorrect printer port settings. For example, an incorrect port number or port type may have been specified. In such situations, your attempt to print fails because the document data cannot reach the machine. To fix this type of problem, configure the printer port settings on the computer.

IMPORTANT

- To perform the following procedure, log in to your computer with an administrator account.

- 1 Open the printer folder. ▶ **Displaying the Printer Folder(P. 338)**
- 2 Right-click the driver icon for this machine, and click [Printer properties] or [Properties].
- 3 Click the [Ports] tab and configure the required settings.

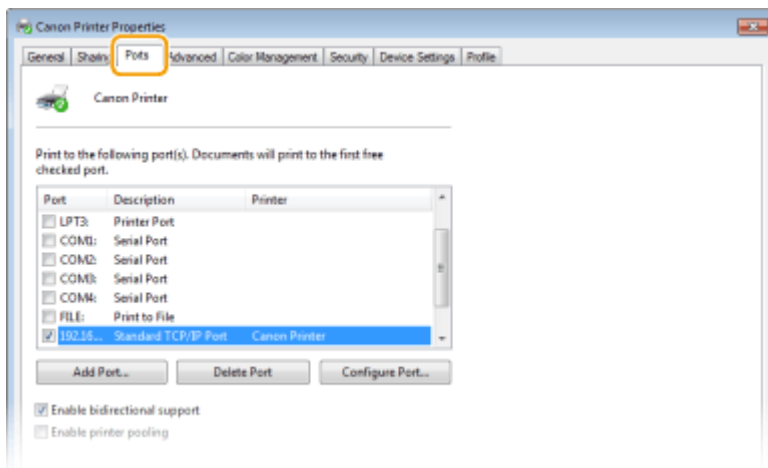

■ Adding a port

If you have changed the IP address of the machine or you have selected an incorrect port while installing drivers from the Windows printer folder, add a new port. There are two types of port: "MFNP Port" and "Standard TCP/IP Port." Select the port type according to your environment.

<p>MFNP Port (only for IPv4 environment)</p>	<p>This is a port that allows the IP address of the machine to be detected automatically. Even if the IP address of the machine is changed, the connection is maintained, provided that the machine and the computer are in the same subnet. You do not need to add a new port every time the IP address is changed. If you are using the machine in an IPv4 environment, you should normally select this type of port.</p> <p>IMPORTANT:</p> <ul style="list-style-type: none"> You can add an MFNP port only when you installed the driver from the provided CD-ROM/DVD-ROM, or when you downloaded and installed the printer driver from the Canon website.
--	--

Standard TCP/IP Port	This is a standard Windows port. When you use this type of port, you need to add a new port every time that the IP address of the machine is changed. Select this type of port when you are using the machine in an IPv6 environment and when you cannot add an MFNP port.
----------------------	--

Adding an MFNP port

- 1 Click [Add Port].
- 2 Select [Canon MFNP Port] in [Available port types] and click [New Port].
- 3 Select [Auto Detect] and select the machine when it is detected, and then click [Next].

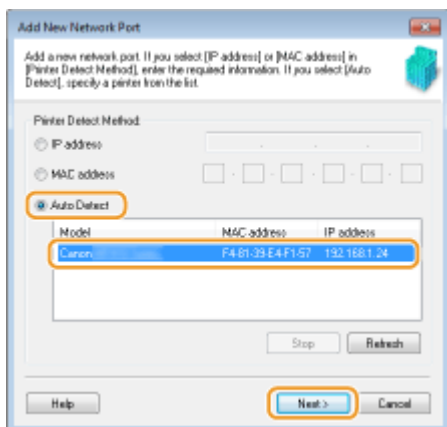

NOTE:

If the machine is not detected

- Click [Refresh]. If the problem persists, select [IP address] or [MAC address], enter the IP address or MAC address of the machine ([Viewing Network Settings\(P. 34\)](#)) and then click [Next].

- 4 Click [Add] ► [Finish].
- 5 Click [Close].

Adding a standard TCP/IP port

- 1 Click [Add Port].
- 2 Select [Standard TCP/IP Port] in [Available port types] and click [New Port].
- 3 Click [Next].
- 4 Enter the IP address or the DNS name of the machine, and click [Next].
 - The [Port Name] is entered automatically. If necessary, you can change it.

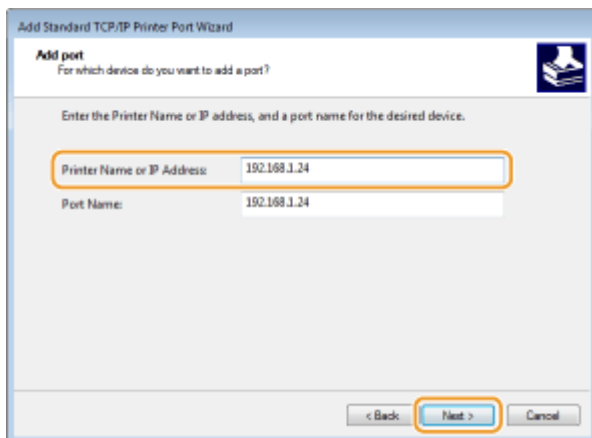

NOTE:

- When the next screen is displayed, follow the instructions on the screen.

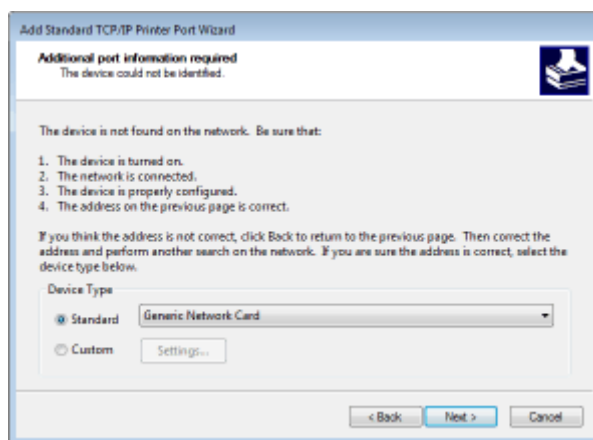

*When you select the [Device Type], select [Canon Network Printing Device with P9100] under [Standard].

- 5 Click [Finish].
- 6 Click [Close].

■ Changing the port type or number

If the printing protocol (LPD or RAW) has been changed on the machine side ([▶Configuring Printing Protocols and WSD Functions\(P. 37\)](#)) or the port number has been changed ([▶Changing Port Numbers\(P. 176\)](#)), the corresponding settings on the computer must also be configured. This operation is not needed for WSD ports.

MFNP port

- 1 Click [Configure Port].
- 2 Under [Protocol Type], select [RAW] or [LPR], and change the [Port Number].
- 3 Click [OK].

Standard TCP/IP port

- 1 Click [Configure Port].
- 2 Under [Protocol], select [Raw] or [LPR].

- If you selected [Raw], change the [Port Number].
- If you selected [LPR], enter "lp" in [Queue Name].

3 Click [OK].

4 Click [Close].

LINKS

🔗 [Setting Up Print Server\(P. 43\)](#)

Setting Up Print Server

38CS-00X

With a print server, you can reduce the load on the computer that you print from. The print server also makes it possible to install the drivers on each computer over the network, which saves you the trouble of installing the drivers on each computer by using the provided CD-ROM/DVD-ROM. To set up a computer on the network as a print server, configure the settings for sharing the printer.

IMPORTANT

- To perform the following procedure, log in to your computer with an administrator account.
- You may be unable to install drivers over the network depending on the operating system and the bit architecture (32-bit or 64-bit) of the print server and client computers.
- When implementing a print server in a domain environment, consult your Network Administrator.

1 Open the printer folder. ▶ **Displaying the Printer Folder(P. 338)**

2 Right-click the printer driver icon for this machine and click **[Printer properties]** or **[Properties]**.

3 Click the **[Sharing]** tab, select **[Share this printer]**, and enter the share name of the machine.

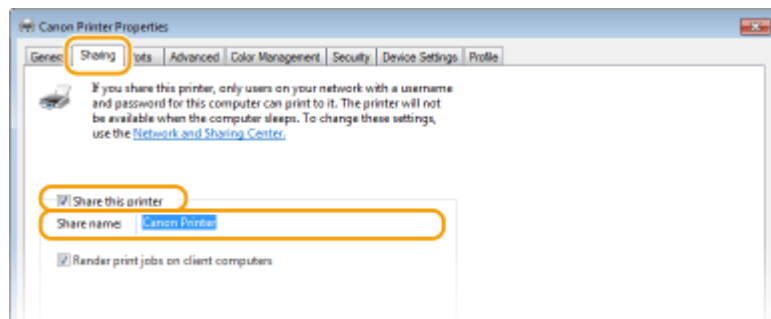

NOTE:

- Click the **[Change Sharing Options]** button if displayed.

4 Install additional drivers as necessary.

- This operation is required if you want to install the drivers in other computers running a different bit architecture via the print server.

1 Click **[Additional Drivers]**.

2 Select the check box for the bit architecture that other computers are running, and click **[OK]**.

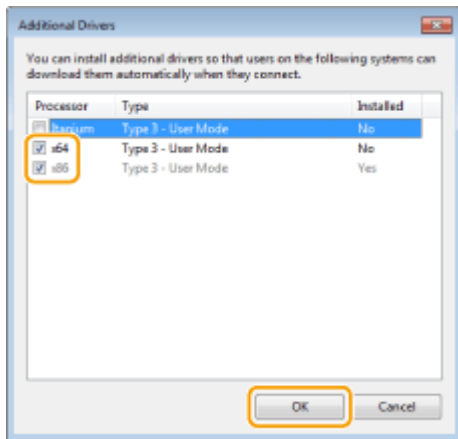

- Select additional drivers from the following, according to the operating system of the print server.

Print server	Select the check box for
32-bit operating systems	[x64]
64-bit operating systems	[x86] under [Processor]

NOTE:

- If you do not know whether your Windows operating system is a 32-bit or 64-bit version, see [▶ Checking the Bit Architecture\(P. 341\)](#) .

- 3 Insert the provided CD-ROM/DVD-ROM into the drive on the computer, click [Browse] to specify the folder that contains the drivers, and then click [OK].
 - If the print server runs a 32-bit operating system, select [intdrv] ▶ [UFRII] ▶ [uk_eng] ▶ [x64] ▶ [Driver] folders on the provided CD-ROM/DVD-ROM.
 - If the print server runs a 64-bit operating system, select [intdrv] ▶ [UFRII] ▶ [uk_eng] ▶ [32BIT] ▶ [Driver] folders on the provided CD-ROM/DVD-ROM.
- 4 Follow the on-screen instructions to install additional drivers.

5 Click [OK].

■ Installing the Drivers on a Computer via the Print Server

- 1 Locate the shared printer in the print server. [▶ Displaying Shared Printers in the Print Server\(P. 339\)](#)
- 2 Double-click the shared printer.
- 3 Follow the on-screen instructions to install the drivers.

▶ **Printing from a Computer(P. 119)**

Configuring the Machine for Your Network Environment

38CS-00Y

The configuration of a network varies depending on the purpose of the network. The machine has been designed to be compatible with as many network configurations as possible, and it is equipped with a variety of technologies. Consult your Network Administrator and set a configuration to suit your network environment.

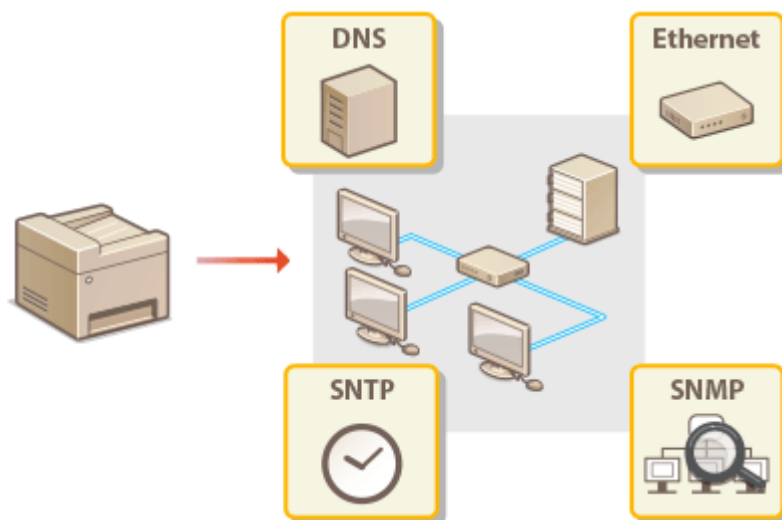

- ▶ **Configuring Ethernet Settings(P. 47)**
- ▶ **Changing the Maximum Transmission Unit(P. 49)**
- ▶ **Setting a Wait Time for Connecting to a Network(P. 50)**
- ▶ **Configuring DNS(P. 51)**
- ▶ **Monitoring and Controlling the Machine with SNMP(P. 54)**
- ▶ **Configuring SNTP(P. 58)**

Configuring Ethernet Settings

38CS-010

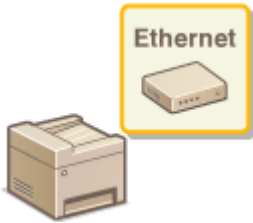

Ethernet is a standard for communicating data in a local area network (LAN). You can set the communication mode and the Ethernet type. In general, the machine can be used without changing the defaults (▶<Ethernet Driver Settings>(P. 222)), but you can change these settings to suit your network environment.

1 Select <Menu> in the Home screen. ▶<Home Screen>(P. 78)

2 Select <Network Settings>.

- If the screen for entering a PIN appears, enter the correct PIN. ▶<Setting the System Manager PIN>(P. 164)

3 Select <Ethernet Driver Settings> ▶ <Auto Detect>.

4 Select whether to configure Ethernet settings automatically or manually.

- If auto-detection is enabled, the machine detects and automatically sets the Ethernet communication mode and the type that can be used.

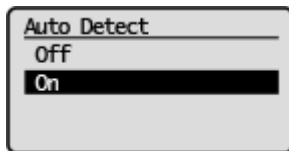

■ Configuring Ethernet settings automatically

Select <On>.

■ Configuring Ethernet settings manually

1 Select <Off>.

2 <Communication Mode> ▶ select the communication mode.

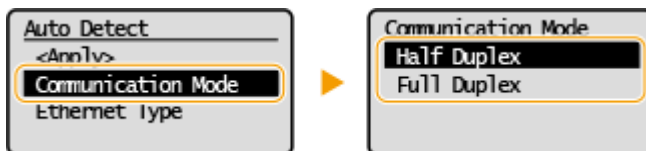

<Half Duplex>

Alternately sends and receives communication data. Select when the machine is connected to a networking device using half duplex.

<Full Duplex>

Simultaneously sends and receives communication data. Use this setting for most environments.

3 <Ethernet Type> ▶ select the Ethernet type.

- 4 Select <Apply>.

LINKS

- ▶ **Changing the Maximum Transmission Unit(P. 49)**
- ▶ **Setting a Wait Time for Connecting to a Network(P. 50)**

Changing the Maximum Transmission Unit

38CS-011

In most Ethernet networks, the maximum size of a packet that can be sent is 1500 bytes. A packet refers to a chunk of data into which the original data is divided before being sent. The maximum transmission unit (MTU) may vary on each network. Change the settings of the machine as necessary. For more information, contact your Network Administrator.

1 Select <Menu> in the Home screen. [▶Home Screen\(P. 78\)](#)

2 Select <Network Settings>.

- If the screen for entering a PIN appears, enter the correct PIN. [▶Setting the System Manager PIN\(P. 164\)](#)

3 Select <TCP/IP Settings> ▶ <MTU Size>.

4 Select the MTU.

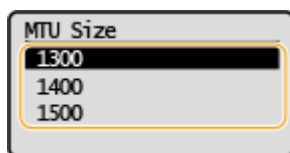

LINKS

[▶Configuring Ethernet Settings\(P. 47\)](#)

[▶Setting a Wait Time for Connecting to a Network\(P. 50\)](#)

Setting a Wait Time for Connecting to a Network

38CS-012

When a network is designed to enjoy redundant connectivity with multiple switching hubs or bridges, it must have a mechanism to prevent packets from looping. One effective solution is to define the role of each switch port. However, communication may still be disrupted for several tens of seconds immediately after you change the way that network devices are connected, or if you add a new device. If this type of problem occurs, set a wait time for connecting to the network.

- 1** Select <Menu> in the Home screen. [▶Home Screen\(P. 78\)](#)

- 2** Select <Network Settings>.
 - If the screen for entering a PIN appears, enter the correct PIN. [▶Setting the System Manager PIN\(P. 164\)](#)

- 3** Select <Waiting Time for Connection at Startup>.

- 4** Enter the waiting time required to start a communication with the network, and press .

LINKS

- [▶Configuring Ethernet Settings\(P. 47\)](#)
- [▶Changing the Maximum Transmission Unit\(P. 49\)](#)

Configuring DNS

38CS-013

DNS (Domain Name System) provides a service for name resolution that associates a host (or domain) name with an IP address. Configure the DNS, mDNS, or DHCP option settings as necessary. Note that the procedures for configuring DNS are different for IPv4 and IPv6.



NOTE

- For more information about the basic operations to be performed when setting the machine from the Remote UI, see [▶Setting Up Menu Options from Remote UI\(P. 205\)](#) .

- 1 Start the Remote UI and log in to System Manager Mode. ▶Starting Remote UI(P. 198)**
- 2 Click [Settings/Registration] on the Portal page. ▶Remote UI Screen(P. 199)**
- 3 Click [Network Settings] ▶ [TCP/IP Settings].**
- 4 Configure DNS settings.**

■Configuring IPv4 DNS

- 1** Click [Edit] in [IPv4 Settings].
- 2** Configure IPv4 DNS settings.

a [DNS Settings]

[Primary DNS Server Address]
Enter the IP address of a DNS server.

[Secondary DNS Server Address]
Enter the IP address of a secondary DNS server, if any.

[Host Name]
Enter alphanumeric characters for the host name of the machine that is to be registered to the DNS server.

[Domain Name]
Enter alphanumeric characters for the name of the domain the machine belongs to, such as "example.com."

[DNS Dynamic Update]
Select the check box to dynamically update the DNS records whenever the machine's IP address is changed. When specifying the interval between updates, enter the time in hours in the [DNS Dynamic Update Interval] text box.

b [mDNS Settings]

[Use mDNS]
Adopted by Bonjour, mDNS (multicast DNS) is a protocol for associating a host name with an IP address without using DNS. Select the check box to enable mDNS and enter the mDNS name in the [mDNS Name] text box.

c [DHCP Option Settings]

[Acquire Host Name]
Select the check box to enable Option 12 to obtain the host name from the DHCP server.

[DNS Dynamic Update]
Select the check box to enable Option 81 to dynamically update the DNS records through the DHCP server.

3 Click [OK].

■ Configuring IPv6 DNS

1 Click [Edit] in [IPv6 Settings].

2 Configure IPv6 DNS settings.

- The [Use IPv6] check box must be selected to configure the settings. **▶ Setting IPv6 Addresses(P. 31)**

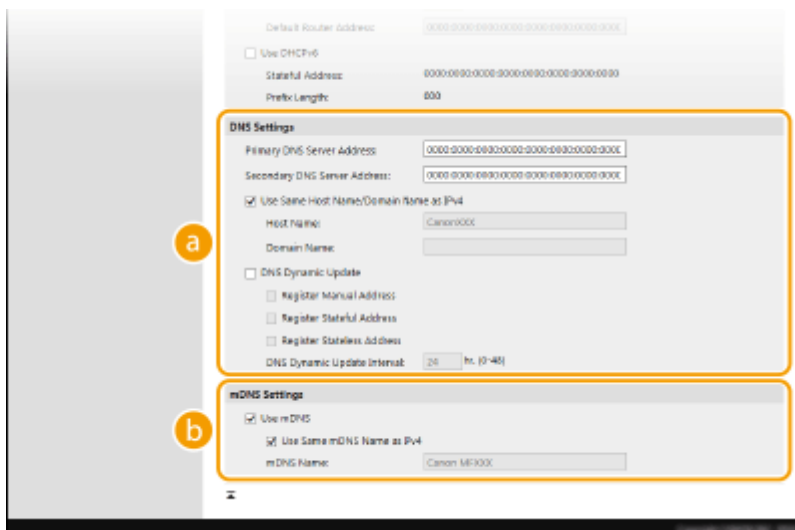

a [DNS Settings]**[Primary DNS Server Address]**

Enter the IP address of a DNS server. Addresses that start with "ff" (or multicast address) cannot be entered.

[Secondary DNS Server Address]

Enter the IP address of a secondary DNS server, if any. Addresses that start with "ff" (or multicast address) cannot be entered.

[Use Same Host Name/Domain Name as IPv4]

Select the check box to use the same host and domain names as in IPv4.

[Host Name]

Enter alphanumeric characters for the host name of the machine that is to be registered to the DNS server.

[Domain Name]

Enter alphanumeric characters for the name of the domain the machine belongs to, such as "example.com."

[DNS Dynamic Update]

Select the check box to dynamically update the DNS records whenever the machine's IP address is changed. To specify the type(s) of addresses you want to register to the DNS server, select the check box for [Register Manual Address], [Register Stateful Address], or [Register Stateless Address]. To specify the interval between updates, enter the time in hours in the [DNS Dynamic Update Interval] text box.

b [mDNS Settings]**[Use mDNS]**

Adopted by Bonjour, mDNS (multicast DNS) is a protocol for associating a host name with an IP address without using DNS. Select the check box to enable mDNS.

[Use Same mDNS Name as IPv4]

Select the check box to use the same mDNS name as in IPv4. To set a different name, clear the check box and enter the mDNS name in the [mDNS Name] text box.

3 Click [OK].**NOTE****Selecting settings from the operation panel**

- DNS settings can also be accessed from <Menu> in the Home screen.
 - ▶<IPv4 Settings>(P. 217)
 - ▶<IPv6 Settings>(P. 218)

LINKS

- ▶Setting IPv4 Address(P. 28)
- ▶Setting IPv6 Addresses(P. 31)
- ▶Viewing Network Settings(P. 34)

Monitoring and Controlling the Machine with SNMP

38CS-014

Simple Network Management Protocol (SNMP) is a protocol for monitoring and controlling communication devices in a network by using Management Information Base (MIB). The machine supports SNMPv1 and security-enhanced SNMPv3. You can check the status of the machine from a computer when you print documents or use the Remote UI. You can enable either SNMPv1 or SNMPv3, or both at the same time. Specify the settings for each version to suit your network environment and the purpose of use.

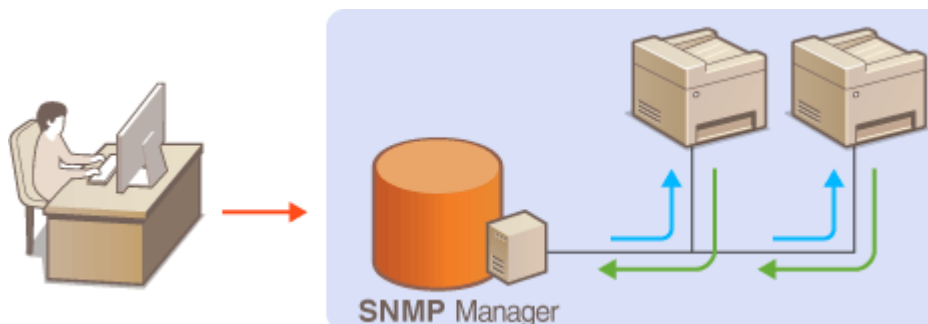

SNMPv1

SNMPv1 uses information called "community" to define the scope of SNMP communication. Because this information is exposed to the network in plain text, your network will be vulnerable to attacks. If you want to ensure network security, disable SNMPv1 and use SNMPv3.

SNMPv3

With SNMPv3, you can implement network device management that is protected by robust security features. Note that TLS must be enabled for the Remote UI before configuring SNMPv3 ([▶Configuring the Key and Certificate for TLS\(P. 179\)](#)).

NOTE

- The machine does not support the trap notification feature of SNMP.
- To change the port number of SNMP, see [▶Changing Port Numbers\(P. 176\)](#) .
- SNMP management software, when installed on a computer on the network, enables you to configure, monitor, and control the machine remotely from the computer. For more information, see the instruction manuals for your management software.
- For more information about the basic operations to be performed when setting the machine from the Remote UI, see [▶Setting Up Menu Options from Remote UI\(P. 205\)](#) .

- 1 Start the Remote UI and log in to System Manager mode.** [▶Starting Remote UI\(P. 198\)](#)
- 2 Click [Settings/Registration] on the Portal page.** [▶Remote UI Screen\(P. 199\)](#)
- 3 Select [Network Settings] ▶ [SNMP Settings].**
- 4 Click [Edit].**

5 Specify SNMPv1 settings.

- If you do not need to change SNMPv1 settings, proceed to the next step.

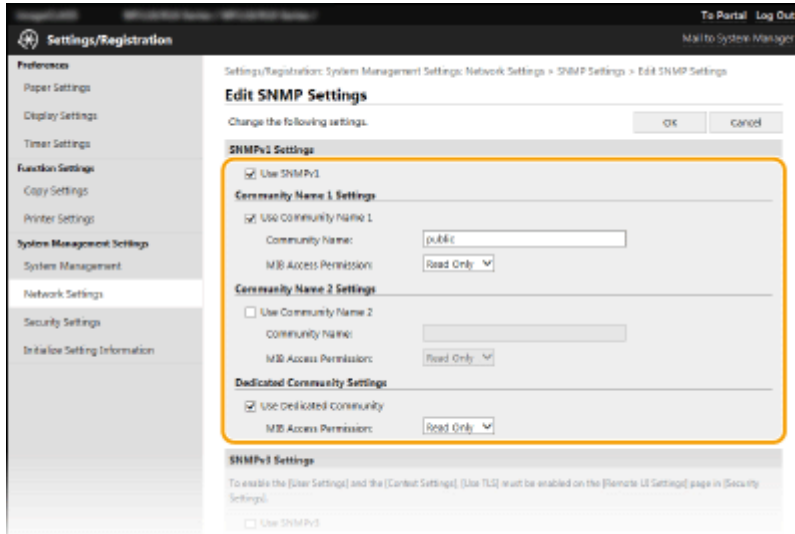

[Use SNMPv1]

Select the check box to enable SNMPv1. You can specify the rest of SNMPv1 settings only when this check box is selected.

[Use Community Name 1]/[Use Community Name 2]

Select the check box to specify a community name. If you do not need to specify a community name, clear the check box.

[Community Name]

Enter alphanumeric characters for the name of the community.

[MIB Access Permission]

For each community, select [Read/Write] or [Read Only] for the access privileges to MIB objects.

[Read/Write]	Permits both viewing and changing the values of MIB objects.
[Read Only]	Permits only viewing the values of MIB objects.

[Use Dedicated Community]

Dedicated Community is a preset community, intended exclusively for Administrators using Canon software. Select the check box to use Dedicated Community, and specify [MIB Access Permission]. If you do not need to use Dedicated Community, clear the check box.

6 Specify SNMPv3 settings.

- If you do not need to change SNMPv3 settings, proceed to the next step.

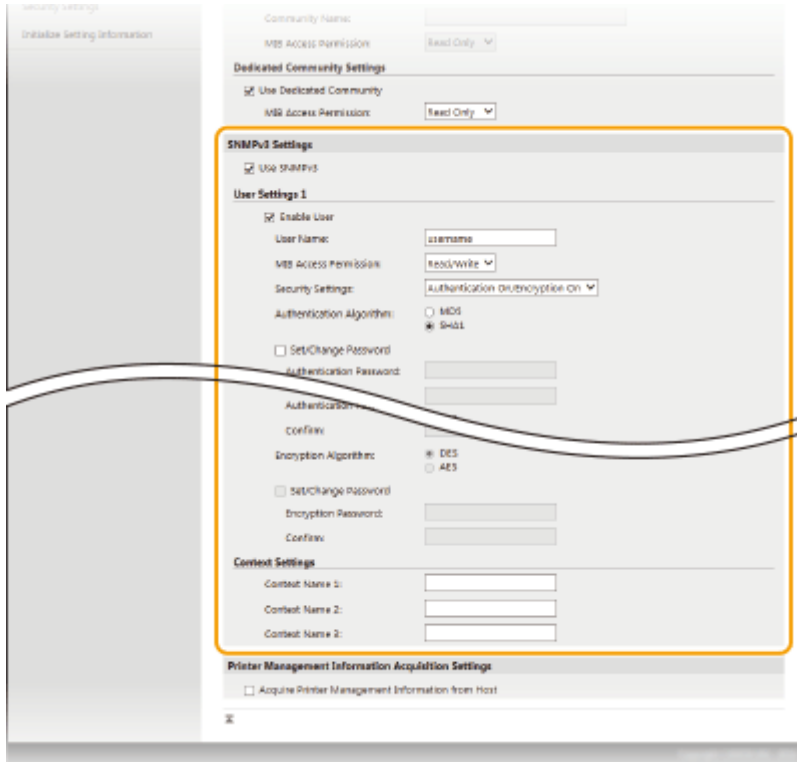

[Use SNMPv3]

Select the check box to enable SNMPv3. You can specify the rest of SNMPv3 settings only when this check box is selected.

[Enable User]

Select the check box to enable [User Settings 1]/[User Settings 2]/[User Settings 3]. To disable user settings, clear the corresponding check box.

[User Name]

Enter alphanumeric characters for the user name.

[MIB Access Permission]

Select [Read/Write] or [Read Only] for the access privileges to MIB objects.

[Read/Write]	Permits both viewing and changing the values of MIB objects.
[Read Only]	Permits only viewing the values of MIB objects.

[Security Settings]

Select [Authentication On/Encryption On], [Authentication On/Encryption Off], or [Authentication Off/Encryption Off] for the desired combination of authentication and encryption settings.

[Authentication Algorithm]

Click the [Authentication On/Encryption On] or [Authentication On/Encryption Off] for [Security Settings] for the algorithm that corresponds to your environment.

[Encryption Algorithm]

Click the [Authentication On/Encryption On] for [Security Settings] for the algorithm that corresponds to your environment.

[Set/Change Password]

To set or change the password, select the check box and enter alphanumeric characters for the password in the [Authentication Password] or [Encryption Password] text box. For confirmation, enter the same password in the [Confirm] text box. Passwords can be set independently for authentication and encryption algorithms.

[Context Name 1]/[Context Name 2]/[Context Name 3]

Enter alphanumeric characters for the context name. Up to three context names can be registered.

7 Specify Printer Management Information Acquisition Settings.

- With SNMP, the printer management information, such as printing protocols and printer ports, can be monitored and obtained regularly from a computer on the network.

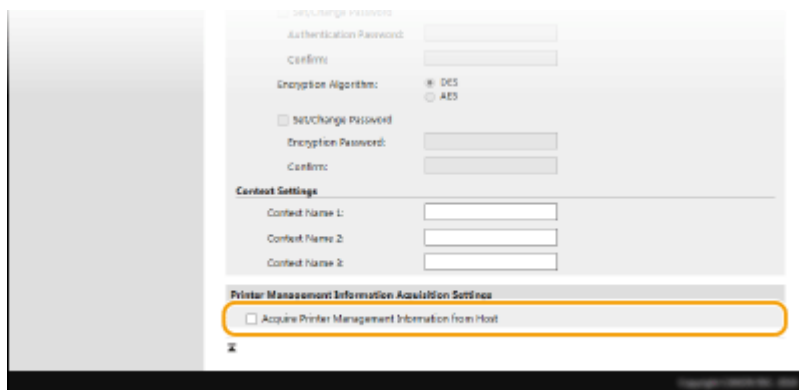

[Acquire Printer Management Information from Host]

Select the check box to enable monitoring of the printer management information of the machine via SNMP. To disable monitoring of the printer management information, clear the check box.

8 Click [OK].

NOTE

Disabling SNMPv1

- If SNMPv1 is disabled, some of the functions of the machine become unavailable, such as obtaining machine information via the printer driver.

Using the operation panel

- You can also specify SNMPv1 settings and enable/disable SNMPv3 settings from <Menu>. ▶<SNMP Settings>(P. 220)

Enabling Both SNMPv1 and SNMPv3

- If both versions of SNMP are enabled, it is recommended that MIB access permission in SNMPv1 be set to [Read Only]. MIB access permission can be set independently in SNMPv1 and SNMPv3 (and for each user in SNMPv3). Selecting [Read/Write] (full access permission) in SNMPv1 negates the robust security features that characterize SNMPv3 because most of the machine settings can then be controlled with SNMPv1.

LINKS

- ▶<Configuring the Key and Certificate for TLS(P. 179)

Configuring SNTP

38CS-015

Simple Network Time Protocol (SNTP) enables you to adjust the system clock by using the time server on the network. If SNTP is used, the time server is checked at the specified intervals; therefore, the correct time can always be maintained. The time is adjusted based on Coordinated Universal Time (UTC), so specify the time zone setting before configuring SNTP ([▶Setting the Date/Time\(P. 9\)](#)). SNTP settings can be specified via the Remote UI.

NOTE

- The SNTP of the machine supports both NTP (version 3) and SNTP (versions 3 and 4) servers.
- For more information about the basic operations to be performed when setting the machine from the Remote UI, see [▶Setting Up Menu Options from Remote UI\(P. 205\)](#) .

- 1 Start the Remote UI and log in to System Manager Mode. [▶Starting Remote UI\(P. 198\)](#)**
- 2 Click [Settings/Registration] on the Portal page. [▶Remote UI Screen\(P. 199\)](#)**
- 3 Select [Network Settings] ▶ [TCP/IP Settings].**
- 4 Click [Edit] in [SNTP Settings].**
- 5 Select the [Use SNTP] check box and specify the required settings.**

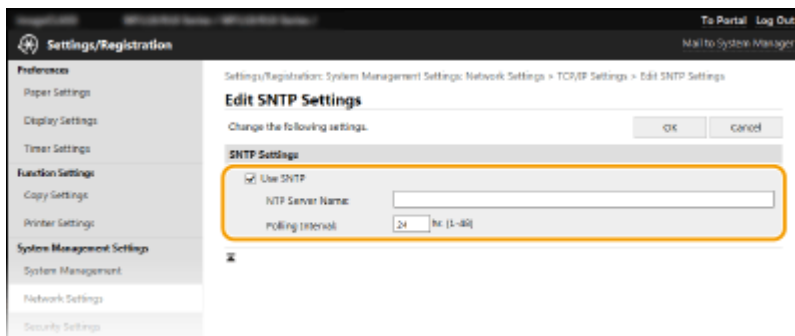

[Use SNTP]

Select the check box to use SNTP for synchronization. If you do not want to use SNTP, clear the check box.

[NTP Server Name]

Enter the IP address of the NTP or the SNTP server. If DNS is available on the network, you can enter a host name (or FQDN) consisting of alphanumeric characters instead (example: ntp.example.com).

[Polling Interval]

Specify the interval between one synchronization and the next.

- 6 Click [OK].**

NOTE

Testing communication with the NTP/SNTP server

- You can view communication status with the registered server by clicking [Settings/Registration] ► [Network Settings] ► [TCP/IP Settings] ► [Check NTP Server] in [SNTP Settings]. If a proper connection has been established, the result is displayed as shown below. Note that this operation does not adjust the system clock.

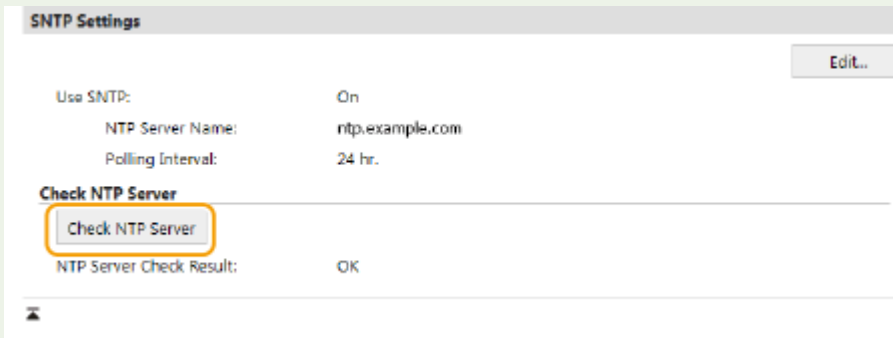

The screenshot displays the 'SNTP Settings' window. It includes an 'Edit...' button in the top right corner. The configuration is as follows:

Use SNTP:	On
NTP Server Name:	ntp.example.com
Polling Interval:	24 hr.

Below the configuration is a section titled 'Check NTP Server' which contains a button labeled 'Check NTP Server' (highlighted with a yellow box). Underneath this button, the 'NTP Server Check Result:' is shown as 'OK'.

Installing Drivers

38CS-016

Install the various drivers and associated software on your computer.

1 Make the necessary preparation before proceeding with the installation.

- If the machine is supplied with a CD-ROM/DVD-ROM, insert the CD-ROM/DVD-ROM into the drive on the computer.
- You can download drivers and software you are going to use from the Canon website (<http://www.canon.com/>).

NOTE:

- When new versions of drivers and software become available, they will be uploaded to the Canon website. You can download them as necessary after checking their system requirements.
- Depending on your machine or environmental conditions, some functions may not be available.
- Some of the drivers are not supported depending on the OS. For more information about the supported status of the latest OS, see the Canon website.

2 Proceed with the installation.

- For more information about the installation procedure, see the manuals for the drivers and software you are going to use.

IMPORTANT

- Installation of drivers is impossible if receiving of the IP address are not permitted in [IP Address Filter]. For more information, see [Specifying IP Addresses for Firewall Settings\(P. 171\)](#) .
- If receiving of the IP address of the computer on which drivers are installed become disabled by [IP Address Filter], it is no longer possible to perform printing from that computer.

Configuring Scan Settings

38CS-017

To save scanned originals to a computer, you need to complete preparations in advance, including installation of software to a computer. Set the necessary configuration depending on your network environment.

Saving to a Computer

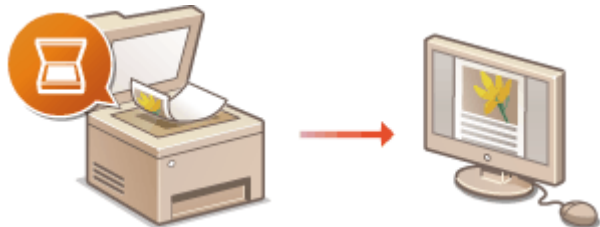

▶ [Preparing to Use the Machine as a Scanner\(P. 62\)](#)

LINKS

▶ [System Environment\(P. 330\)](#)

▶ [Scan Function\(P. 327\)](#)

Preparing to Use the Machine as a Scanner

38CS-018

To use this machine as a scanner, you must complete preparations in advance, including installation of software to a computer. For more information, see the manuals for the relevant drivers on the online manual website. In Windows, when connecting this machine to a computer via a wireless or wired LAN, you need to register this machine in "MF Network Scanner Selector" using the following procedure. This procedure is not required if the machine and your computer are connected via USB.

IMPORTANT

- The scan function is not available if the machine and your computer are connected in an IPv6 environment. Use IPv4 or a USB connection.

1 Click  in the system tray.

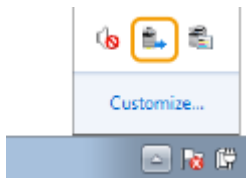

2 Select the check box for the machine, and click [OK].

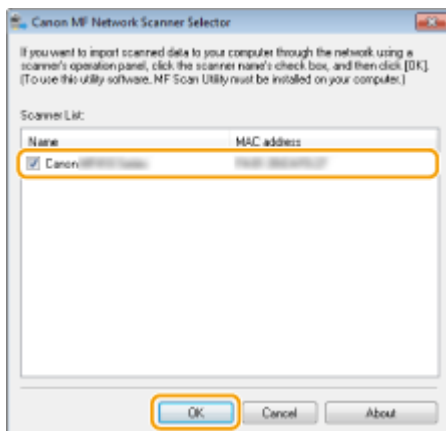

Basic Operations

Basic Operations	64
Parts and Their Functions	67
Front Side	68
Back Side	70
Drawer	71
Operation Panel	72
Turning ON the Machine	74
Turning OFF the Machine	75
Using the Operation Panel	76
Basic Screens	77
Home Screen	78
<Status Monitor> Screen	79
Message Display	80
Basic Operation	81
Entering Text	83
Placing Originals	84
Loading Paper	86
Loading Paper in the Drawer	88
Loading Envelopes	92
Loading Preprinted Paper	94
Specifying Paper Size and Type	95
Specifying Paper Size and Type in the Drawer	96
Registering a Custom Paper Size	97
Limiting the Paper Sizes Displayed	98
Customizing the Display	99
Customizing the Home Screen	100
Changing the Default Settings for Functions	101
Entering Sleep Mode	102

Basic Operations

38CS-019

This chapter describes basic operations, such as how to use the operation panel or how to load the paper, that are frequently performed to use the functions of the machine.

■ Parts and Their Functions

This section describes the exterior and interior parts of the machine and their functions, as well as how to use the keys on the operation panel and how to view the display. ▶ **Parts and Their Functions(P. 67)**



■ Turning ON the Machine

This section describes how to turn the machine ON and OFF. ▶ **Turning ON the Machine(P. 74)**



■ Using the Operation Panel

This section describes how to use the display for tasks such as selecting items and adjusting settings. Also, it describes how to enter characters and numbers. ▶ **Using the Operation Panel(P. 76)**

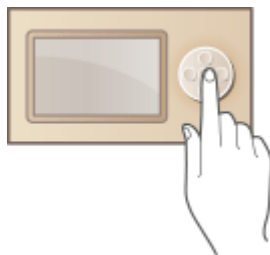

■ Placing Originals

This section describes how to place originals on the platen glass. ▶ **Placing Originals(P. 84)**



■ Loading Paper

This section describes how to load the paper into the drawer. ▶ **Loading Paper(P. 86)**

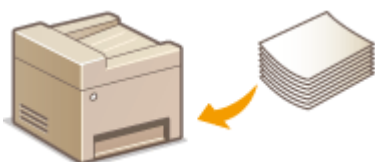

■ Customizing the Display

This section describes how to rearrange Home screen menu items. ▶ **Customizing the Display(P. 99)**



■ Changing the Default Settings for Functions

This section describes how to change the setting that is displayed initially when a function is selected. ▶ **Changing the Default Settings for Functions(P. 101)**

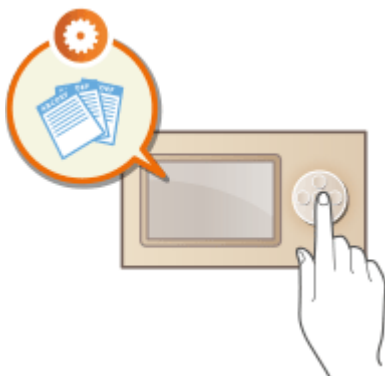

■ Entering Sleep Mode

This section describes how to set the sleep mode. ▶ **Entering Sleep Mode(P. 102)**

Basic Operations



Parts and Their Functions

38CS-01A

This section describes the parts of the machine (exterior, front side and back side) and how they function. In addition to describing the parts of the machine used for such basic operations as loading paper and replacing the toner cartridges, etc., this section also describes the keys on the operation panel. Read this section for tips on how to use the machine properly.

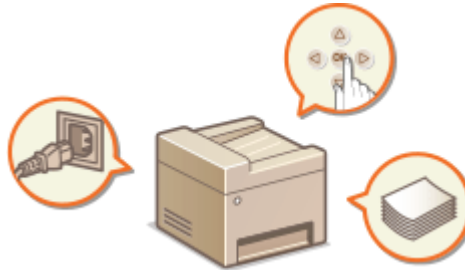

- ▶ **Front Side(P. 68)**
- ▶ **Back Side(P. 70)**
- ▶ **Drawer(P. 71)**
- ▶ **Operation Panel(P. 72)**

Front Side

38CS-01C

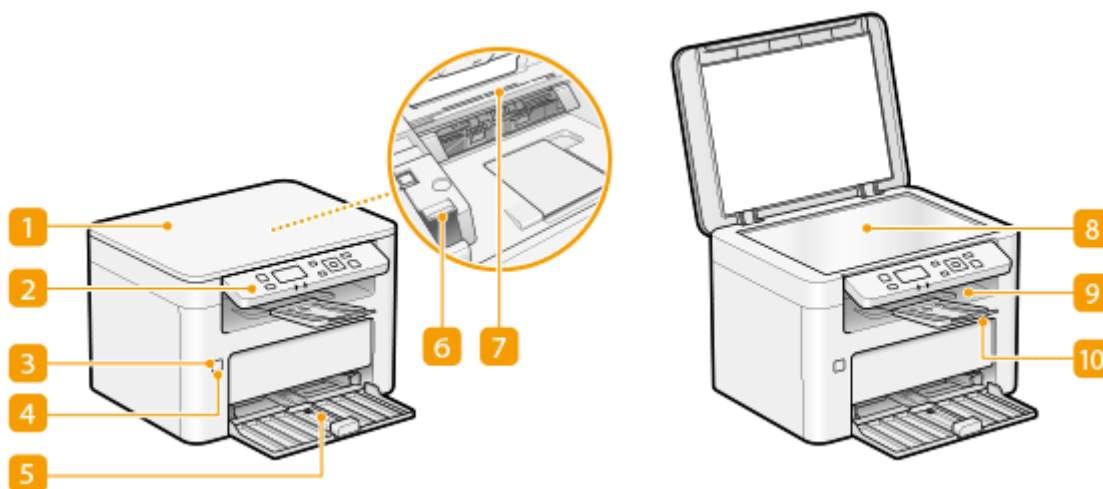

1 Platen glass cover

Open to place originals on the platen glass. ▶ **Placing Originals(P. 84)**

2 Operation panel

The operation panel consists of keys such as the [Home] key, [Stop] key, a display, and status indicators. You can perform all the operations and specify settings from the operation panel.

▶ **Operation Panel(P. 72)**

▶ **Basic Screens(P. 77)**

3 Power indicator

Lights up when the power is turned ON.

4 Power switch

Turns the power ON or OFF. To restart the machine, turn OFF the machine, wait for at least 10 seconds, and turn it back ON.

5 Drawer

Load the paper to print in this tray. ▶ **Loading Paper in the Drawer(P. 88)**

6 Toner cover

Open the toner cover when replacing toner cartridges or drum cartridges.

▶ **Procedure for Replacing the Toner Cartridge(P. 256)**

▶ **Procedure for Replacing the Drum Cartridge(P. 259)**

7 Ventilation slots

Air from inside the machine is vented out to cool down the inside of the machine. Note that placing objects on the ventilation slots prevents ventilation.

8 Platen glass

When scanning originals, place them on the platen glass. ▶ **Placing Originals(P. 84)**

9 Output tray

Printed paper is output to the output tray.

10 Paper stopper

Open the paper stopper when you want to prevent paper from falling out of the output tray.

Back Side

38CS-01E

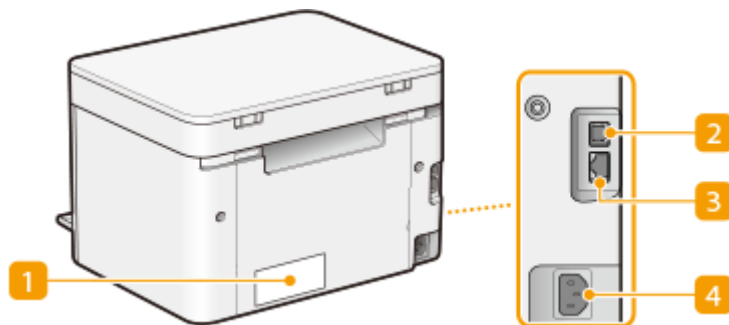

1 Rating label

The label shows the serial number, which is needed when making inquiries about the machine. ▶ **When a Problem Cannot Be Solved(P. 310)**

2 USB port

Connect a USB cable when connecting the machine and a computer.

3 LAN port

Connect a LAN cable when connecting the machine to a wired LAN router, etc. ▶ **Connecting to a Wired LAN(P. 14)**

4 Power socket

Connect the power cord.

Drawer

38CS-01F

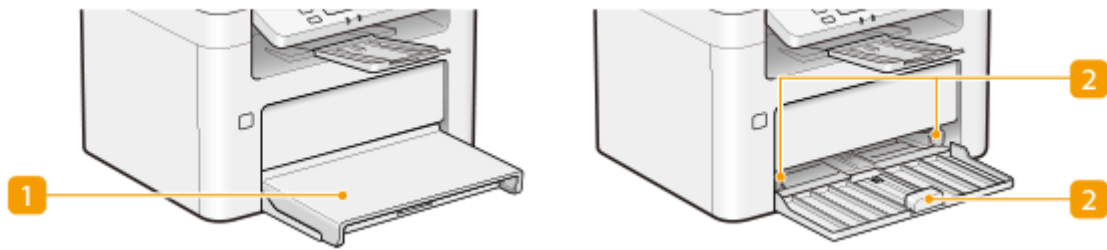

1 Paper cover

Remove this cover to load paper in the drawer.

2 Paper guides

Adjust the paper guides to exactly the size of the loaded paper to ensure that paper is fed straight into the machine.

LINKS

🔗 [Loading Paper in the Drawer\(P. 88\)](#)

Operation Panel

38CS-01H

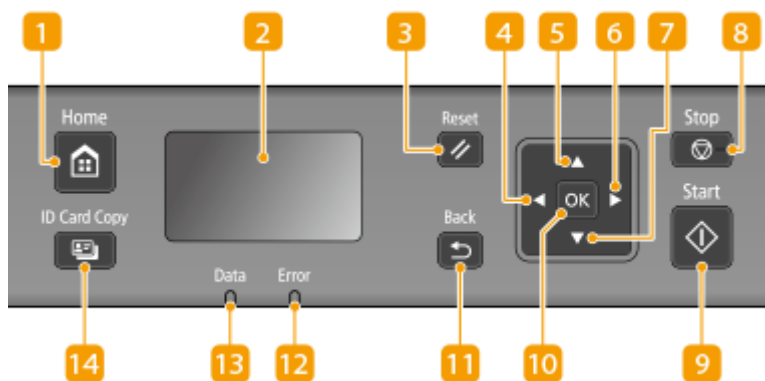

1 [Home] key

Press to display the Home screen, which provides access to the setting menu and functions such as copy and scan.

- ▶ **Home Screen(P. 78)**
- ▶ **Customizing the Home Screen(P. 100)**

2 Display (screen)

You can view the operation and error statuses of this machine, the amount remaining in the toner cartridges, etc.

- ▶ **Basic Screens(P. 77)**
- ▶ **Basic Operation(P. 81)**

3 [Reset] key

Press to cancel the settings and restore the previously specified settings.

4 [◀] key

- When specifying settings, press to return to the previous screen.
- When entering text, press to select the item you want to use.
- Press to decrease a setting value such as the contrast of the display.

5 [▲] key

- When specifying settings, press to select the item immediately above the currently selected item.
- When changing setting values, press to increase a value.

6 [▶] key

- When specifying settings, press to proceed to the next screen.
- When entering text, press to select the item you want to use.
- Press to increase a setting value such as the contrast of the display.

7 [▼] key

- When specifying settings, press to select the item immediately below the currently selected item.
- When changing setting values, press to decrease a value.

8 [Stop] key

Press to cancel printing and other operations.

9 [Start] key

Press to scan or copy originals.

10 [OK] key

Press to apply settings or specified details.

11 [Back] key

Press to return to the previous screen. If you press this key when specifying settings, for example, the settings are not applied and the display returns to the previous screen.

12 [Error] indicator

Blinks or lights up when an error such as a paper jam occurs.

13 [Data] indicator

Blinks while operations such as sending or printing are being performed. Lights up when there are documents waiting to be processed.

14 [ID Card Copy] key

Press to enter a mode for copying the front and back sides of a driver's license or other ID card onto the same side of a page at actual size. ▶ **Making ID Card Copies(P. 116)**

LINKS

▶ **Basic Operation(P. 81)**

Turning ON the Machine

38CS-01J

This section describes how to turn ON the machine.

1 Make sure that the power plug is firmly inserted into a power outlet.

2 Press the power switch.

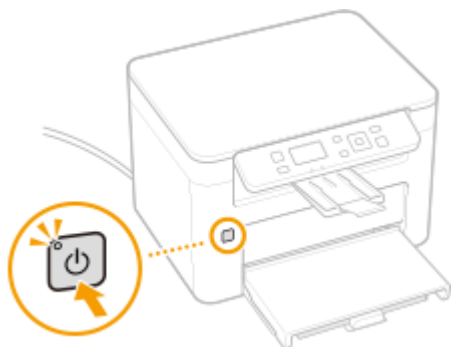

⇒ The power indicator lights and the machine is ready for printing.

NOTE

- You can select the screen that is displayed first after the machine is turned ON. ▶<Default Screen after Startup/Restoration>(P. 223)
- A blank sheet of paper may be output when you turn ON the power for the first time after purchasing the machine. This is not a malfunction.

LINKS

▶Turning OFF the Machine(P. 75)

Turning OFF the Machine

38CS-01K

This section describes how to turn OFF the machine.

1 Press the power switch.

- Make sure that the power indicator has gone out.

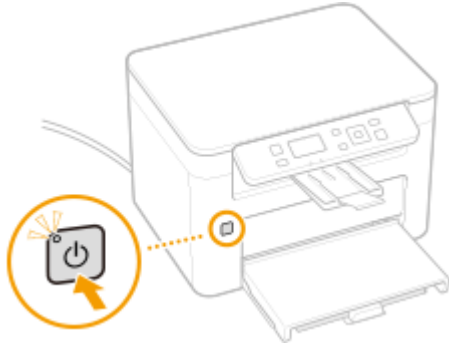

NOTE

- It may take some time for the machine to completely shut down. Do not unplug the power cord until the display turns off.
- To restart the machine, wait for at least 10 seconds after the machine is turned OFF.
- Even when the power is turned OFF, the machine continues to consume a small amount of power. To reduce power consumption to zero, unplug the power plug from the AC power outlet.

Using the Operation Panel

38CS-01L

You can use the display and keys of the operation panel to configure machine settings or operate functions. This section describes basic usage of the display and keys.



- ▶ **Basic Screens(P. 77)**
- ▶ **Basic Operation(P. 81)**
- ▶ **Entering Text(P. 83)**

TIPS

- If you want to invert the light and dark parts of the display: ▶ **<Invert Screen Colors>(P. 224)**
- If you want to adjust the contrast of the display: ▶ **<Contrast>(P. 223)**

LINKS

- ▶ **Operation Panel(P. 72)**

Basic Screens

38CS-01R

The Home screen or settings screen appears on the display, allowing you to initiate functions such as copy and scan. You can also use the display to check information such as error messages and the machine's operation status.

- ▶ **Home Screen(P. 78)**
- ▶ **<Status Monitor> Screen(P. 79)**
- ▶ **Message Display(P. 80)**

Home Screen

The Home screen is displayed when the power is turned ON or by pressing  on the operation panel. Use this screen to specify settings for and register functions.

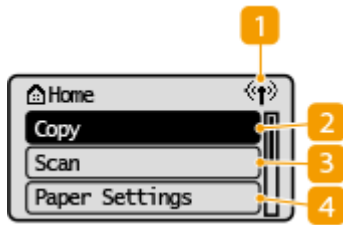

1 Wi-Fi icon

Displayed when the machine is connected to a wireless LAN.

2 <Copy>

Use this item to start copying. [▶ Copying\(P. 104\)](#)

3 <Scan>

Scans an original and converts it into an electronic file. [▶ Scanning\(P. 126\)](#)

4 <Paper Settings>

This item is used for specifying the size and type of paper loaded in the drawer. [▶ Specifying Paper Size and Type\(P. 95\)](#)

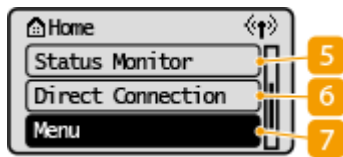

5 <Status Monitor>

Select this item to check the printing status, to view the usage history, or to view the network settings such as the IP address of the machine. You can also check the status of the machine, such as the amount remaining in the toner cartridge, etc., or whether any errors occurred. [▶ <Status Monitor> Screen\(P. 79\)](#)

6 <Direct Connection>

Select this item to connect the mobile device and the machine directly without using a wireless LAN router. [▶ Connecting Directly \(Access Point Mode\)\(P. 142\)](#)

7 <Menu>

<Network Settings>, <Preferences>, and many other machine settings start from this item. [▶ Setting Menu List\(P. 213\)](#)

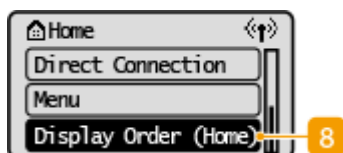

8 <Display Order (Home)>

Allows you to change the order that Home screen items are displayed in. [▶ Customizing the Home Screen\(P. 100\)](#)

LINKS

[▶ Customizing the Home Screen\(P. 100\)](#)

<Status Monitor> Screen

When you select <Status Monitor>, a screen appears in which you can check the progress of document processing as well as the status of the machine (the amount of toner remaining in the toner cartridges, etc.) and network settings such as the machine's IP address.

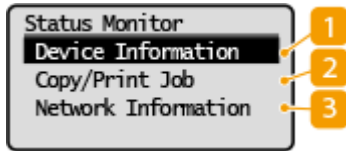

1 <Device Information>

Displays the status of the machine, such as the amount remaining in the toner cartridges, etc.

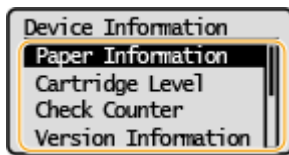

<Paper Information>

Displays the paper size specified in the drawer.

<Cartridge Level>

Displays the amount remaining in the toner cartridge and the drum cartridge. Other internal parts may reach the end of their lifetime before the amount remaining in the toner cartridge or the drum cartridge reaches its lifetime.

<Check Counter>

Displays the total for printouts. [▶Viewing the Counter Value\(P. 265\)](#)

<Version Information>

Displays firmware version information.

<Serial Number>

Displays the serial number.

2 <Copy/Print Job>

Displays the current copy/print statuses and the logs for printed documents. [▶Checking the Printing Status and Log\(P. 123\)](#)

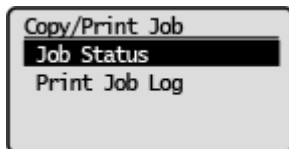

3 <Network Information>

Displays the network settings such as the IP address of the machine and status such as the condition of wireless LAN communications. [▶Viewing Network Settings\(P. 34\)](#)

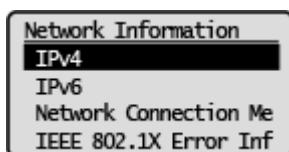

Message Display

38CS-01W

Messages are displayed on the screen in situations such as when paper runs out or when the expiration of the toner cartridge lifetime is reached. **▶ Countermeasures for Each Message (P. 296)**

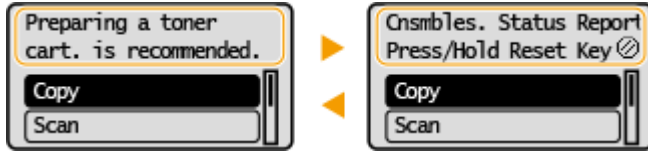

When an Error Occurs

In some cases when an error occurs, instructions on how to respond to the error are displayed. Follow the on-screen instructions to solve the problem. The screen displayed when a paper jam occurs is shown below as an example.

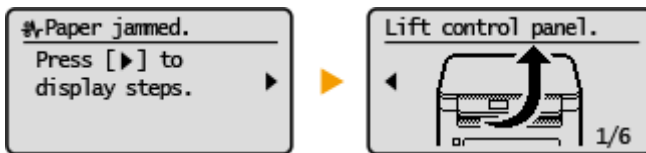

Basic Operation

38CS-01X

Use the keys shown below to specify settings and adjust values.



Using ▲ / ▼

■ Scrolling the Screen

The scroll bar is displayed on the right side of the screen when not all of the information fits on one screen. If the scroll bar is displayed, use ▲ / ▼ to scroll up or down. The text and background colors of an item are inverted when it is selected.

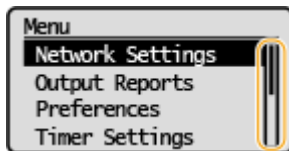

■ Changing Setting Values

Use ▲ / ▼ to enter values.

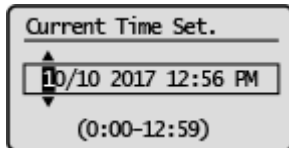

NOTE:

- Values in () displayed below the entry box are the enterable value range.
- You can also use ▲ / ▼ to select the item you want to use when entering text. ▶ [Entering Text\(P. 83\)](#)

Using ◀ / ▶

■ Proceeding to the Next Screen/Returning to the Previous Screen

Press ▶ to proceed to the next screen. Press ◀ to return to the previous screen.



NOTE:

- You can also proceed to the next screen by pressing **OK**, and return to the previous screen by pressing the [Back] key.

■ Changing Setting Values

Use ◀ / ▶ to adjust the slider scale.

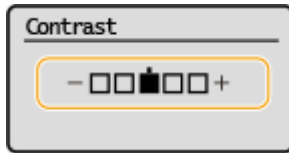

■ Moving the Cursor

Use ◀ / ▶ to enter values.

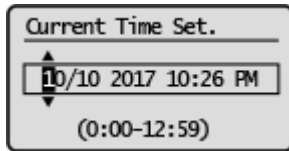

NOTE:

- When entering text, use <◀> / <▶> on the display to move the cursor. ▶ **Entering Text(P. 83)**

Using

Press  to apply a setting.

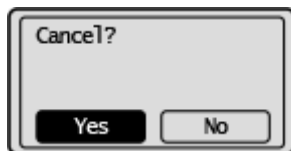

TIPS

- You can change a variety of display-related settings, such as the scrolling speed or the display language: ▶ **<Display Settings>(P. 223)**

Entering Text

Use the keys shown on the display to enter text and values. Select a character or number you want, and press **OK**.



Selecting the Type of Text

Select <Switch Entry Mode> and press **OK** to display the screen for selecting the type of text that is entered. Select the type of text and press **OK**.



Deleting Text

Select **<C>** on the screen, and press **OK** to delete the character you entered.

NOTE

- When **<◀>** and **<▶>** do not appear on the screen, you can select **<C>** on the screen and press **OK** to delete all of the characters you entered.

Entering a Space

Select **<Space>** and press **OK** to enter a space.

NOTE

- When the cursor is located at the last character, selecting **<▶>** and pressing **OK** allows a space to be entered.

Moving the Cursor

Select **<◀>** or **<▶>** on the screen, and press **OK** to move the cursor.

Placing Originals

38CS-020

Place originals on the platen glass. For information on loadable sizes, etc., see **Main Unit(P. 322)** .



IMPORTANT

Use originals that are completely dry

- When placing originals, make sure that any glue, ink, or correction fluid on the originals has completely dried.

1 Open the platen glass cover.

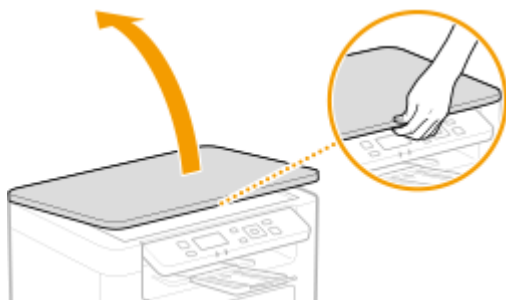

2 Place the original face down on the platen glass.

- Align the corner of the original with the top-left corner of the platen glass.

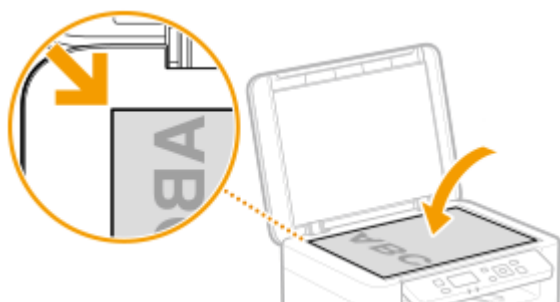

NOTE:

- To scan transparent originals (for example, tracing paper or transparencies), cover them with plain white paper.

3 Gently close the platen glass cover.

- ➡ The machine is ready to scan the original.

NOTE:

When scanning is complete

- Remove the original from the platen glass.

Loading Paper

38CS-021

You can load the paper into the drawer. See [▶Available Paper\(P. 325\)](#) for available paper sizes and types.

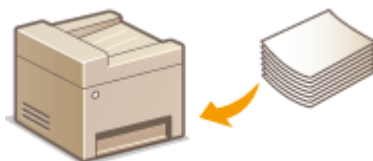

About Paper

- ▶ [Precautions for Paper\(P. 86\)](#)
- ▶ [Storing the Paper Printed with the Machine\(P. 87\)](#)

How to Load Paper

- ▶ [Loading Paper in the Drawer\(P. 88\)](#)
- ▶ [Loading Envelopes\(P. 92\)](#)
- ▶ [Loading Preprinted Paper\(P. 94\)](#)

Configuring the Settings for the Loaded Paper

- ▶ [Specifying Paper Size and Type\(P. 95\)](#)

Precautions for Paper

IMPORTANT

Do not use the following types of paper:

- A paper jam or printing error may occur.
 - Wrinkled or creased paper
 - Curled or rolled paper
 - Torn paper
 - Damp paper
 - Very thin paper
 - Thin coarse paper
 - Paper printed by a thermal transfer printer
 - Back side of paper printed by a thermal transfer printer
 - Highly textured paper
 - Glossy paper

Notes on use of paper

- Only use paper that has fully acclimatized to the environment in which the machine is installed. Using paper that has been stored under different temperature or humidity conditions may cause paper jams or result in poor print quality.

Paper handling and storage

- It is recommended that you use paper as soon as possible after unwrapping. Paper remaining unused should be covered with the original wrapping paper and stored on a flat surface.

- Keep the paper wrapped in its original package to protect the paper from moisture or dryness.
- Do not store the paper in such a way that may cause it to curl or fold.
- Do not store the paper vertically or do not stack too much paper.
- Do not store the paper in direct sunlight, or in a place subject to high humidity, dryness, or drastic changes in temperature or humidity.

NOTE

When printing on paper that has absorbed moisture

- Steam may emit from the paper output area, or water droplets may form around the paper output area. There is nothing unusual about any of these occurrences, which occur when the heat generated from fixing toner on the paper causes moisture in the paper to evaporate (most likely to occur at low room temperatures).

Storing the Paper Printed with the Machine

When handling/storing the paper printed with the machine, take the following precautions.

■ How to Store the Printed Paper

- Store on a flat surface.
- Do not store together with articles made of PVC (polyvinyl chloride) such as clear folders. Toner may melt, resulting in the paper's sticking to PVC articles.
- Take care that the paper does not get folded or creased. Toner may peel off.
- To store over a long period of time (two years or longer), store in binders or equivalent.
- When the paper is stored over a long period of time, it may become discolored and thus the print may seem to have undergone a change of color.
- Do not store in a place where the temperature is high.

■ Precautions When Applying Adhesive

- Always use insoluble adhesive.
- Before applying adhesive, perform a test using a printout no longer required.
- When putting adhesive-applied paper sheets one over another, make sure that the adhesive is completely dried out.

LINKS

- ▶ [Registering a Custom Paper Size\(P. 97\)](#)

Loading Paper in the Drawer

38CS-022

Load the paper into the drawer.

IMPORTANT

Always load paper in portrait orientation

- Paper cannot be loaded in landscape orientation. Be sure to load paper in portrait orientation, as shown in the illustration below.



1 Open the drawer.

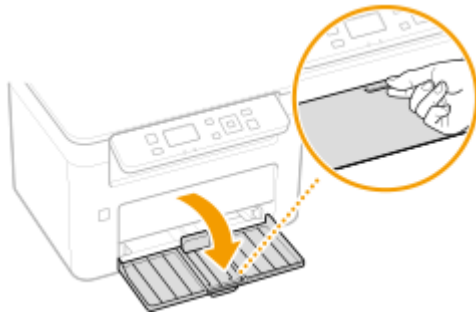

NOTE:

When replenishing paper

When the drawer is already opened and the paper cover is covered, remove the paper cover.

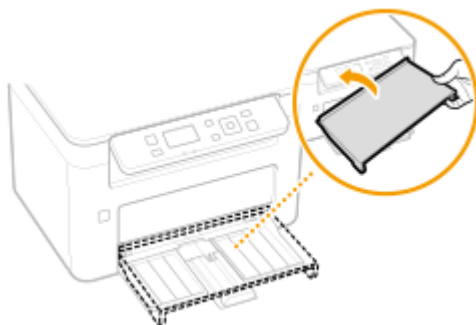

2 Spread the paper guides apart.

- Slide the paper guides outward.

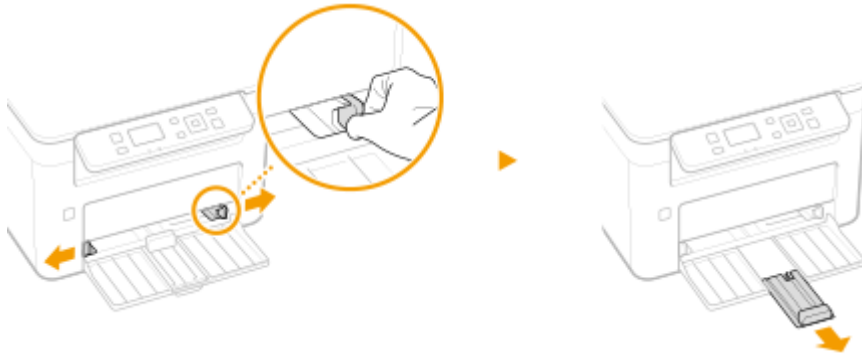

3 Load the paper and slide it all the way in, until it touches the back side.

- Load the paper in portrait orientation (with the short edge toward the machine) and the print side face up. Paper cannot be loaded in landscape orientation.
- Before loading it, fan the paper stack well, and tap it on a flat surface to align the edges.
- When you insert the paper with <Notify to Check Paper Settings> set to <On>, a confirmation screen is displayed. ▶<Notify to Check Paper Settings>(P. 224)



IMPORTANT:

Keep the paper stack within the load limit guides

Make sure that the paper stack does not exceed the load limit guides (a). Loading too much paper may cause paper jams.

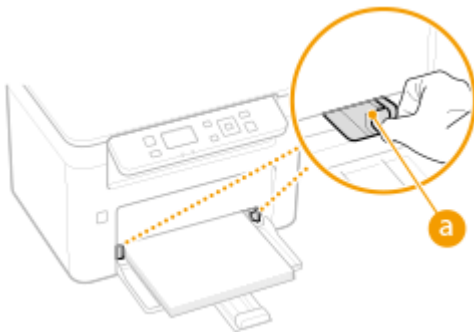

NOTE:

When loading envelopes or preprinted paper, see ▶<Loading Envelopes>(P. 92) or ▶<Loading Preprinted Paper>(P. 94) .

4 Align the paper guides against the edges of the paper.

- Align the paper guides securely against the edges of the paper.

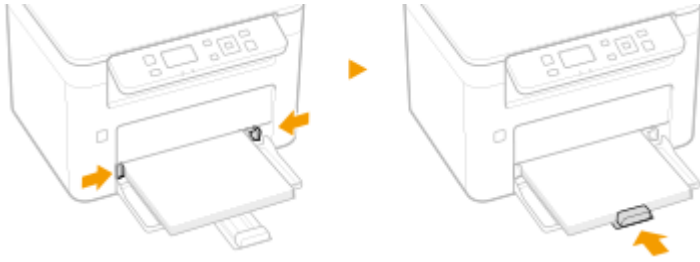
**IMPORTANT:**

Align the paper guides securely against the paper

Paper guides that are too loose or too tight may cause misfeeds or paper jams.

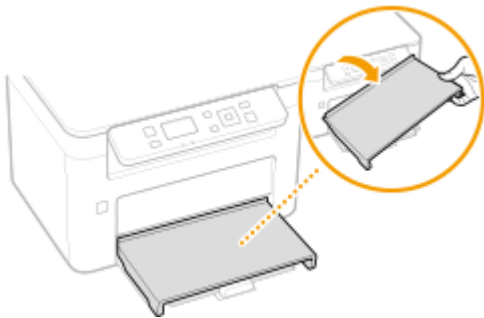
5 Replace the paper cover.**NOTE**

- When performing printing, open the paper stopper in advance so that the output paper does not fall out of the output tray.



» Continue to **Specifying Paper Size and Type in the Drawer (P. 96)**

IMPORTANT:

When changing the paper size or type

- The factory default settings for paper size and type are <A4> and <Plain>, respectively. If you load a different size or type of paper into the machine, make sure to change the settings. If you do not change the settings, the machine cannot print properly.

Printing on the Back Side of Printed Paper (Manual 2-Sided Printing)

- You can print on the back side of printed paper. Flatten any curls on the printed paper and insert it into the drawer, with the side to print face up (previously printed side face down).
 - Load only one sheet of paper each time you print.

Basic Operations

- You can use only the paper printed with this machine.
- You cannot print on the side that has previously been printed on.
- If you are using A5 size paper, the reverse side may not be printed correctly.

LINKS

[▶ Available Paper\(P. 325\)](#)

Loading Envelopes

38CS-023

Make sure to flatten any curls on envelopes before loading them. Also pay attention to the orientation of envelopes and which side is face up.

▶ **Before Loading Envelopes(P. 92)**

▶ **Loading Envelopes in the Drawer(P. 93)**

NOTE

- This section describes how to load envelopes in the orientation you want, as well as procedures that you need to complete before loading envelopes. For a description of the general procedure for loading envelopes in the drawer, see ▶ **Loading Paper in the Drawer(P. 88)** .

Before Loading Envelopes

Follow the procedure below to prepare the envelopes before loading.

1 Close the flap of each envelope.



2 Flatten them to release any remaining air, and make sure that the edges are pressed tightly.



3 Loosen any stiff corners of the envelopes and flatten any curls.

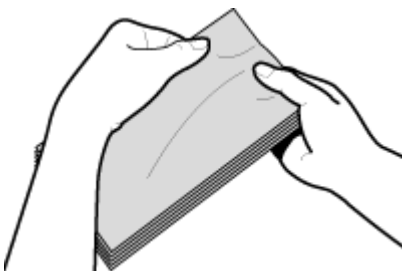

4 Align the edges of the envelopes on a flat surface.

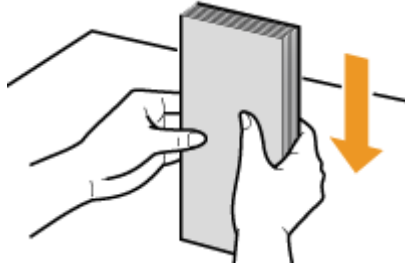

Loading Envelopes in the Drawer

Load the envelopes Monarch, No. 10 (COM10), DL, or C5 in portrait orientation (with the short edge toward the machine), with the non-glued side (front side) face up. You cannot print on the reverse side of envelopes.

NOTE

- Load the envelopes so that the edge with the flap is toward the left side as shown in the illustration.

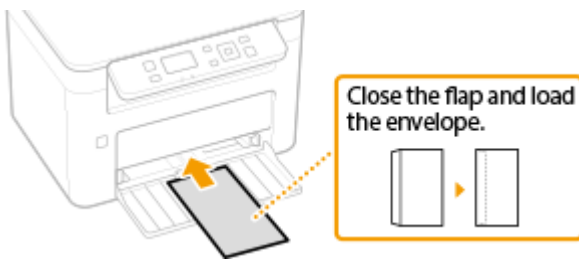

Loading Preprinted Paper

38CS-024

When you use paper that has been preprinted with a logo, pay attention to the orientation of the paper when loading. Load the paper properly so that printing is performed on the correct side of the paper with a logo.



▶ Making Printouts on Paper with Logos (P. 94)

NOTE

- This section mainly describes how to load preprinted paper with the proper facing and orientation. For a description of the general procedure for loading paper in the drawer, see ▶ **Loading Paper in the Drawer (P. 88)** .

Making Printouts on Paper with Logos

Load the paper with the logo side (the side to print the document) face up.

Printing on Paper with Logos in Portrait Orientation

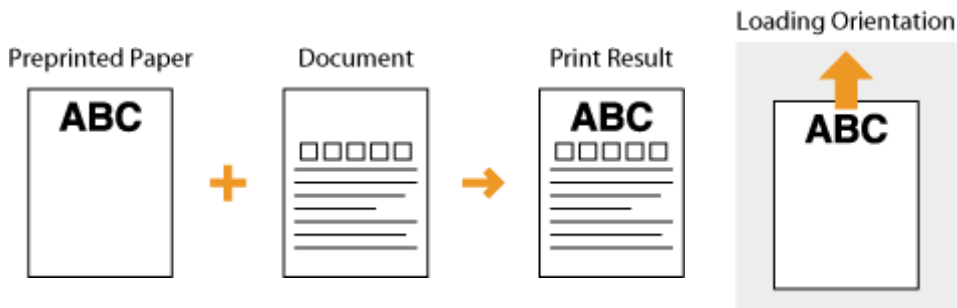

Printing on Paper with Logos in Landscape Orientation

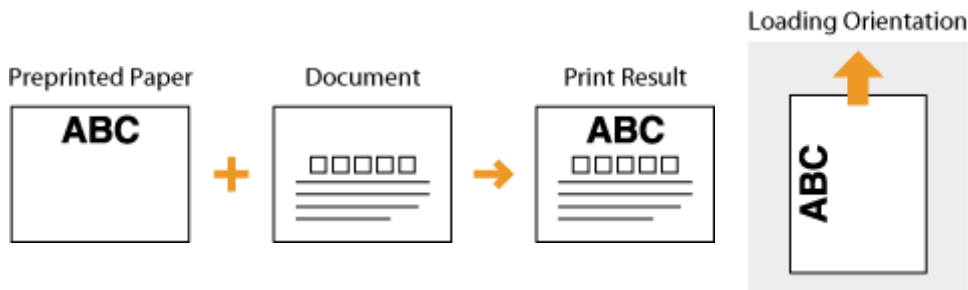

Specifying Paper Size and Type

38CS-025

You must specify the paper size and type settings to match the paper that is loaded. Make sure to change the paper settings when you load the paper that is different from the previously loaded paper.

- ▶ **Specifying Paper Size and Type in the Drawer(P. 96)**
- ▶ **Registering a Custom Paper Size(P. 97)**
- ▶ **Limiting the Paper Sizes Displayed(P. 98)**

IMPORTANT

- If the setting does not match the size and type of loaded paper, a paper jam or printing error may occur.

Specifying Paper Size and Type in the Drawer

38CS-026

1 Select <Paper Settings> in the Home screen. ▶ Home Screen(P. 78)

2 Select <Drawer 1>.

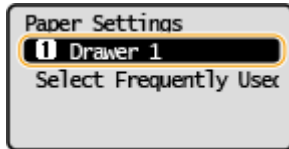

3 Select the paper size.

- If the loaded paper size is not displayed, select <Other Sizes>.

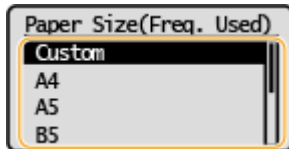

4 Select the paper type.

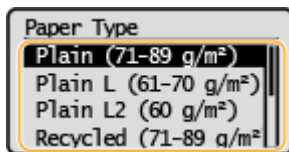

LINKS

- ▶ Loading Paper in the Drawer(P. 88)
- ▶ Limiting the Paper Sizes Displayed(P. 98)
- ▶ Available Paper(P. 325)
- ▶ <Notify to Check Paper Settings>(P. 224)

Registering a Custom Paper Size

38CS-027

You can register one frequently used custom paper size.

1 Select <Paper Settings> in the Home screen. ▶ Home Screen(P. 78)

2 Select <Drawer 1> ▶ <Custom>

3 Specify the length of the <X> side and <Y> side.

- Execute the following steps in sequence: <X> ▶ enter the length of the <X> side using ▲ / ▼ ▶ OK ▶ <Y> ▶ enter the length of the <Y> side ▶ OK



4 Select <Apply>.

5 Select the paper type.

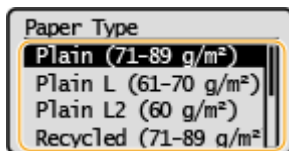

LINKS

▶ Loading Paper in the Drawer(P. 88)

Limiting the Paper Sizes Displayed

38CS-028

You can ensure that only frequently used paper sizes are shown in the <Frequently Used Sizes> screen for selecting the paper size setting.

1 Select <Paper Settings> in the Home screen. [▶Home Screen\(P. 78\)](#)

2 Select <Select Frequently Used Paper Sizes>.

3 Clear the check boxes for paper sizes you do not want displayed.

- Ensure that only the check boxes for frequently used paper sizes are selected.

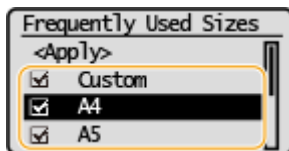

NOTE:

- Paper sizes that are not selected can be viewed by selecting <Other Sizes> in the paper size setting selection screen.

4 Select <Apply>.

LINKS

- [▶Specifying Paper Size and Type in the Drawer\(P. 96\)](#)

Customizing the Display

38CS-029

In order to make the Home screen easier to use, you can customize it.

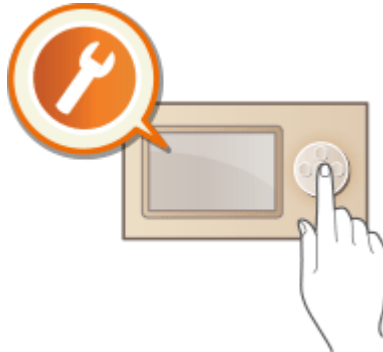

Customizing the Home Screen

You can rearrange the items that are displayed in the Home screen. [▶Customizing the Home Screen\(P. 100\)](#)

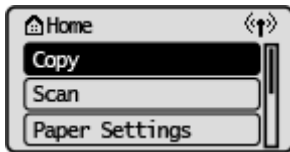

Customizing the Home Screen

38CS-02A

To make the Home screen easier to use, you can freely change the item display order.

1 Select <Display Order (Home)> in the Home screen. ▶ Home Screen(P. 78)

2 Use ▲ / ▼ to select the item to be moved, and press **OK**.

- Press **OK** again to deselect it.

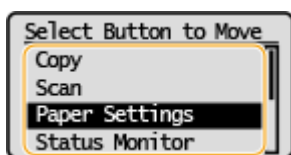

3 Use ▲ / ▼ to move to the target position, and press **OK**.

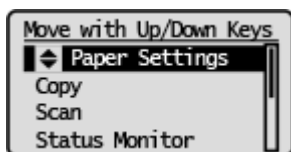

4 When the buttons are rearranged in the way you want, press the [Back] key.

Changing the Default Settings for Functions

38CS-02C

The default settings are the settings that are displayed whenever you turn ON the machine, or when you press the [Reset] key. If you change these default settings to match the operations that you perform frequently, you can eliminate the need to specify the same settings every time you perform an action.

■ Copy

For information about changeable setting items, see [▶<Change Default Settings>\(P. 231\)](#) .



<Menu> ▶ <Copy Settings> ▶ <Change Default Settings> ▶ Select the setting ▶ Change the default value of the selected item ▶ <Apply>

NOTE

- If you select <Initialize Default Settings> on the <Copy Settings> screen, you can restore the default settings.

LINKS

[▶Basic Copy Operations\(P. 105\)](#)

Entering Sleep Mode

38CS-02E

The sleep mode function reduces the amount of power consumed by the machine by disabling power flow to the operation panel. If no operations are performed on the machine for a while, such as during a lunch break, the machine enters sleep mode automatically.

NOTE

When in sleep mode

- When the machine enters sleep mode, the display turns off.

Situations in which the machine does not enter sleep mode

- When the machine is in operation
- When the [Data] indicator is lit up or blinking
- When the machine is performing an operation such as adjustment or cleaning
- When a paper jam occurs
- When the menu screen is displayed
- When an error message is displayed on the screen (There are some exceptions. The machine sometimes enters sleep mode when an error message is displayed.)
- When the machine is waiting for a wireless LAN connection or Direct Connection

Changing the Auto Sleep Time Value

Auto Sleep Time is a function that automatically puts the machine into the sleep mode if it remains idle for a specified length of time. We recommend using the factory default settings (▶<Timer Settings>(P. 227)) to reduce power usage. If you want to change the amount of time that elapses before the machine enters the auto sleep mode, perform the procedure below.



<Menu> ▶ <Timer Settings> ▶ <Auto Sleep Time> ▶ Set the amount of time that elapses before the machine automatically enters sleep mode ▶ 

Exiting Sleep Mode

You can press any key other than the power switch to exit the sleep mode.

Copying

Copying	104
Basic Copy Operations	105
Canceling Copies	108
Checking the Copying Status	109
Enhancing and Adjusting Copy Quality	110
Selecting the Type of Original for Copying	111
Adjusting Sharpness for Copying (Sharpness)	112
Useful Copy Functions	113
Copying Multiple Documents onto One Sheet (N on 1)	114
Collating Copies by Page	115
Making ID Card Copies	116

Copying

This chapter describes basic copy operations and various other useful functions, such as copying several pages onto a single sheet.

■ Using Basic Operations

- ▶ Basic Copy Operations(P. 105)
- ▶ Canceling Copies(P. 108)
- ▶ Checking the Copying Status(P. 109)

■ Enhancing Quality ▶ Enhancing and Adjusting Copy Quality(P. 110)

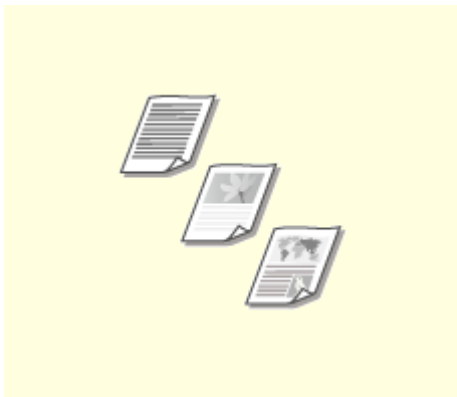

▶ Selecting the Type of Original for Copying(P. 111)

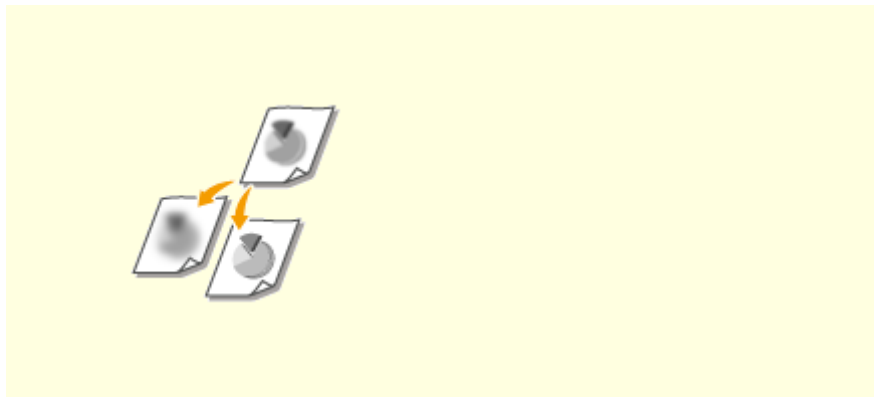

▶ Adjusting Sharpness for Copying (Sharpness)(P. 112)

■ Using Useful Copy Functions ▶ Useful Copy Functions(P. 113)



▶ Copying Multiple Documents onto One Sheet (N on 1)(P. 114)



▶ Collating Copies by Page(P. 115)



▶ Making ID Card Copies(P. 116)

Basic Copy Operations

This section describes the basic operation procedure used to copy an original.

- 1 Place the original(s). ▶ **Placing Originals(P. 84)**
- 2 Select <Copy> in the Home screen. ▶ **Home Screen(P. 78)**
- 3 Select <Number of Copies>.
- 4 Enter the number of copies, and press **OK**.
 - If you have entered an incorrect value, use the [Reset] key to clear it.
- 5 Specify the copy settings as necessary.
 - ▶ Adjusting Density
 - ▶ Enlarging or Reducing

Adjusting Density



You can adjust the density of the copy if the text or images in an original are too light or dark. You can also automatically set an optimal density for an original.



<Density> ▶ Adjust the density ▶ **OK**

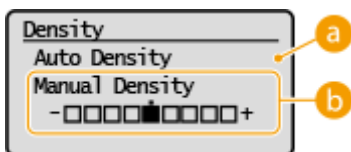

a <Auto Density>

An optimal density for the original is automatically set.

<Original Type> is automatically set to <Text>. ▶ **Selecting the Type of Original for Copying(P. 111)**

b <Manual Density>

Use ◀ / ▶ to adjust the density.

Enlarging or Reducing



You can enlarge or reduce copies by using a preset copy ratio such as <A5->A4/LTR>, or by setting a custom copy ratio in increments of 1 %.

NOTE

- If you make a setting for <N on 1> after setting the copy ratio, the setting of reduction ratio in <N on 1> takes priority.



<Copy Ratio> ▶ Select the copy ratio

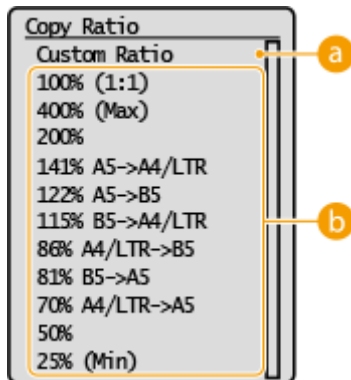

a <Custom Ratio>

Use ▲ / ▼ to enter the copy ratio, and press **OK**. You can set any copy ratio from 25% to 400% in 1% increments.

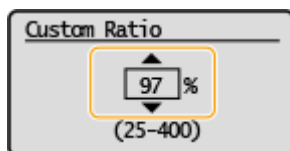

b Preset copy ratio

Select a copy ratio.

NOTE:

- For information about other copy settings, see ▶ **Enhancing and Adjusting Copy Quality(P. 110)** or ▶ **Useful Copy Functions(P. 113)** .

6 Press

⇒ Copying starts.

- If you want to cancel, select <Cancel> ▶ <Yes>. [▶Canceling Copies\(P. 108\)](#)

■For N on 1 copying

For N on 1 copying, the screen prompting you to load the next original is displayed.

1 Place the next original on the platen glass, and Press 

- You can also specify <Density> separately for each original.

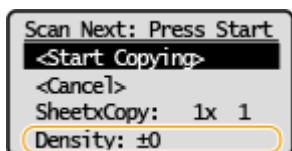

- Repeat this step until you finish scanning the entire original.

2 Select <Start Copying>.

NOTE:

- When the <Size/Settings Mismatch> or <The memory is full. Scanning will be canceled. Print?> message is shown in the display. [▶Countermeasures for Each Message\(P. 296\)](#)

IMPORTANT

When copying originals with text or images that extend to the edges of the page

- The edges of the original might not be copied. For more information about the scan margins, see [▶Main Unit\(P. 322\)](#) .

TIPS

- If you always want to make copies with the same settings: [▶Changing the Default Settings for Functions\(P. 101\)](#)

LINKS

- [▶Checking the Copying Status\(P. 109\)](#)

Canceling Copies

If you want to cancel copying immediately after pressing , select <Cancel> on the screen or press  on the operation panel. You can also cancel copying after checking the copy status.

■ Select <Cancel> on the Screen That is Displayed While Copying

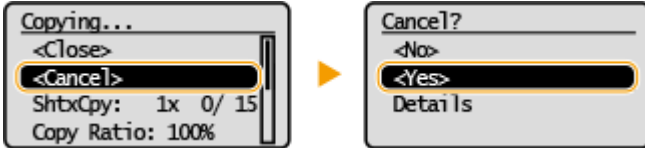

■ Press to Cancel

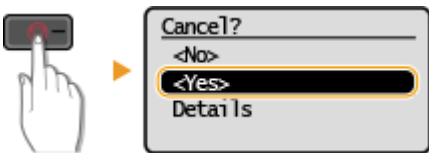

■ Check the copy job status before canceling



<Status Monitor> ▶ <Copy/Print Job> ▶ <Job Status> ▶ Select the document in the <Copy/Print Job Status> screen ▶ <Cancel> ▶ <Yes>

LINKS

▶ Basic Copy Operations(P. 105)

Checking the Copying Status

38CS-02K

You can check the current copy statuses for copied documents.

Useful in the Following Cases

- When some long time has already passed after scanning of your original to be copied but printing of the document has not started yet, you may want to see the waiting list of the documents waiting to be printed.

- 1** Select <Status Monitor> in the Home screen. ▶ Home Screen(P. 78)
- 2** Select <Copy/Print Job>.
- 3** Select <Job Status>.
- 4** Select the document whose status you want to check in the <Copy/Print Job Status> screen, and press **OK**.

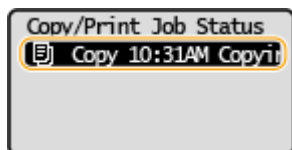

⇒ Displays detailed information about the document.

LINK

- ▶ Basic Copy Operations(P. 105)
- ▶ Canceling Copies(P. 108)

Enhancing and Adjusting Copy Quality

38CS-02L

You can improve the copy quality by specifying more detailed settings, such as selecting the type of original.



▶ **Selecting the Type of Original for Copying(P. 111)**

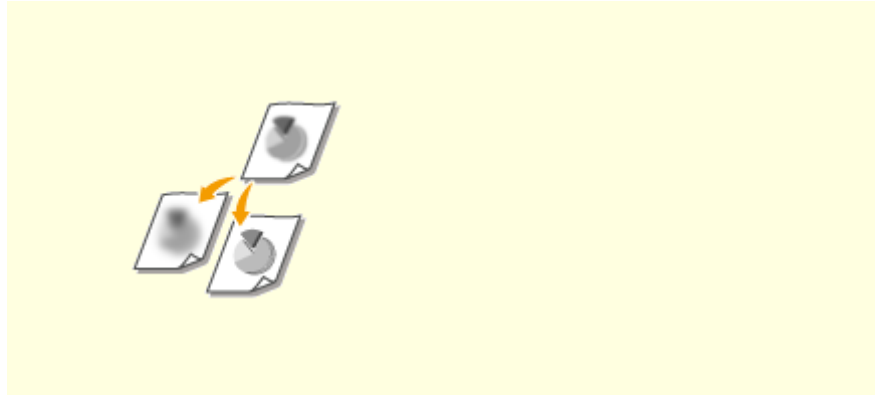

▶ **Adjusting Sharpness for Copying (Sharpness)(P. 112)**

Selecting the Type of Original for Copying

38CS-02R



You can select the optical image quality for the copy depending on the original type, such as text-only documents, documents with charts and graphs, or magazine photos.



<Copy> ▶ <Original Type> ▶ Select the original type

<Text>	Suitable when copying originals that only contain text.
<Text/Photo (High Speed)>	Suitable when copying originals that contain both text and photos. Priority is given to speed over image quality.
<Text/Photo>	Suitable when copying originals that contain both text and photos.
<Photo>	Suitable when copying originals that contain printed photos, such as magazines or pamphlets.

NOTE

- If <Text/Photo (High Speed)>, <Text/Photo>, or <Photo> is selected and <Density> is set to <Auto Density>, it changes to <Manual Density>.

LINKS

🔗 **Basic Copy Operations(P. 105)**

Adjusting Sharpness for Copying (Sharpness)

38CS-02S



You can adjust sharpness of the copied image. Increase the sharpness to sharpen blurred text and lines, or decrease the sharpness to improve the appearance of magazine photos.



<Copy> ▶ <Sharpness> ▶ Adjust the sharpness

Example: If you want to sharpen text and lines written in pencil

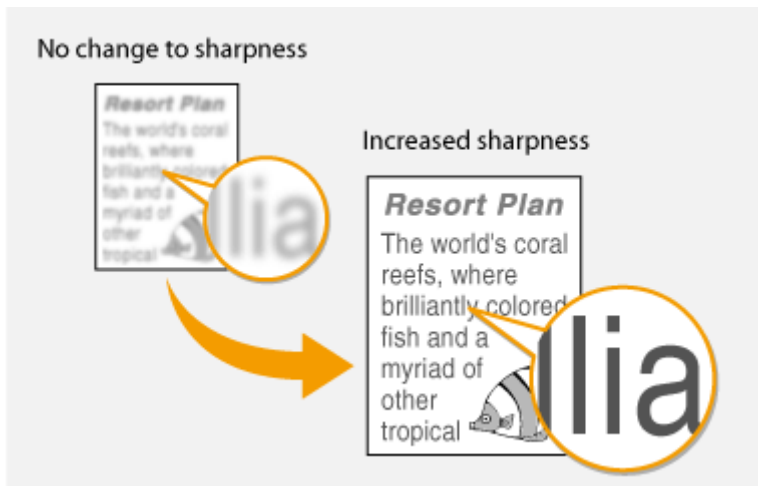

Example: If you want to improve the appearance of magazine photos

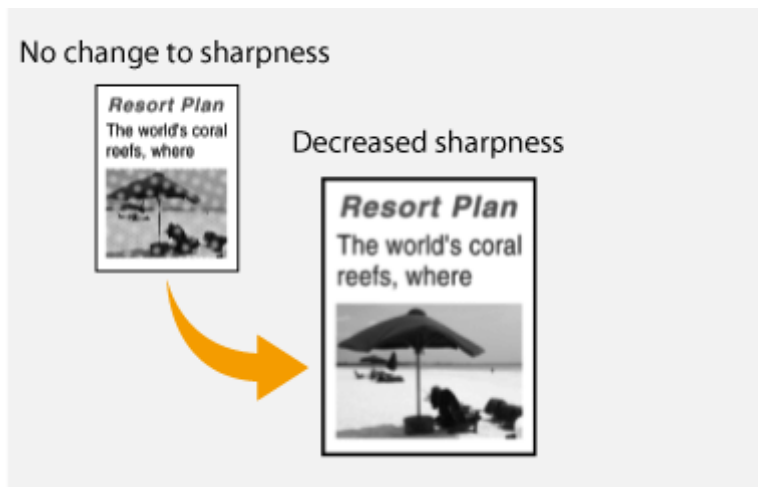

LINKS

🔗 Basic Copy Operations(P. 105)

Useful Copy Functions

38CS-02U

You can copy multiple sheets onto one page, or copy by grouping sheets into complete sets in sequential page order. Also, there is a function to copy both sides of a card, etc. onto one page.

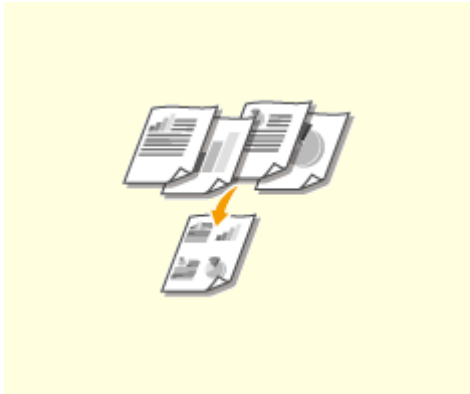

▶ Copying Multiple Documents onto One Sheet (N on 1)(P. 114)



▶ Collating Copies by Page(P. 115)



▶ Making ID Card Copies(P. 116)

Copying Multiple Documents onto One Sheet (N on 1)

38CS-02W



You can reduce the size of a multiple-page original and arrange all pages on one side of the paper. You can save the number of sheets as the document can be copied on fewer pages than those of the original.

NOTE

- Using <N on 1> reduces the copy ratio automatically (the copy ratio is displayed on the screen). If the copying process has not started, you can further reduce the image size by lowering the numeric value that is automatically displayed. But the edges of the original might not be copied if you increase it.
- <N on 1> is not available when using <ID Card Copy>.
- When you copy multiple originals onto one page, margins may be created in the copied image.



<Copy> ► <N on 1> ► Select the number of pages to be combined ► Select the original size on the <Scan Size> screen

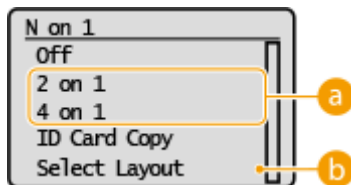

a Number of pages to be combined

Select the number of pages to be combined on one side of paper. For example, <4 on 1> means that "a four-page original can be combined on a single sheet."

b <Select Layout>

Specify how to arrange the originals on the page.

LINKS

▶ **Basic Copy Operations(P. 105)**

Collating Copies by Page



When preparing multiple copies of multi-page originals, set <Collate> to <On> to collate copies in sequential page order. This function is useful when preparing handouts for meetings or presentations.



<Copy> ▶ <Collate> ▶ <On>

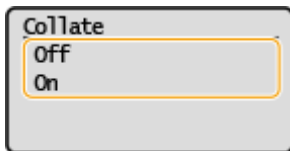

<Off>

The copies are grouped by page and not collated. For example, if you are making three copies of a five-page original, the printouts will be arranged in the following page order: 1, 1, 1, 2, 2, 2, 3, 3, 3, 4, 4, 4, 5, 5, 5.



<On>

The copies are grouped into complete sets in sequential page order. For example, if you are making three copies of a five-page original, the printouts will be arranged in the following page order: 1, 2, 3, 4, 5, 1, 2, 3, 4, 5, 1, 2, 3, 4, 5.



LINKS

🔗 [Basic Copy Operations\(P. 105\)](#)

Making ID Card Copies

38CS-02Y



You can use <ID Card Copy> to copy the front and back sides of a card onto the same side of a page. This function is useful when copying a driver's license or ID card.

NOTE

- <Copy Ratio> is automatically set to <100%>.



Place the card on the platen glass ▶ [ID Card Copy] key ▶  ▶ Turn the card over ▶ 

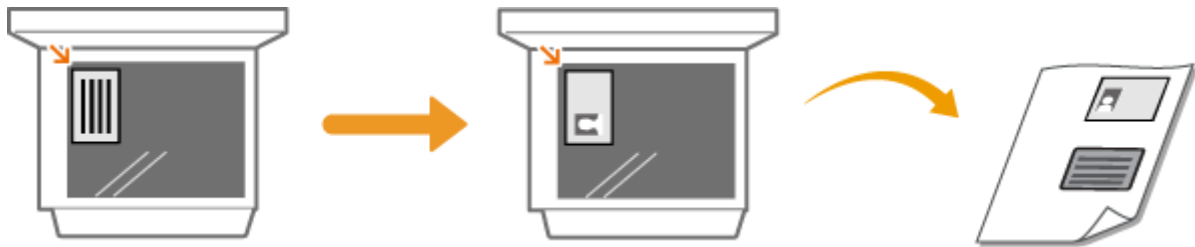

LINKS

▶ **Basic Copy Operations(P. 105)**

Printing

Printing	118
Printing from a Computer	119
Canceling Prints	121
Checking the Printing Status and Log	123

Printing

38CS-030

You can print documents on your computer by using the printer driver.

■ Printing from a Computer

You can print a document made on your computer by using the printer driver.

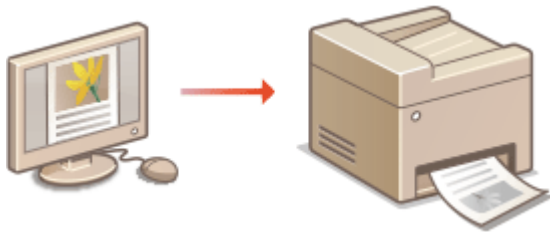

▶ **Printing from a Computer(P. 119)**

Printing from Mobile Devices

- Linking mobile devices such as smartphones or tablets to this machine provides a quick and easy way to print photos and web pages. The machine also supports Google Cloud Print™.
 - ▶ **Linking with Mobile Devices(P. 139)**
 - ▶ **Using Google Cloud Print(P. 157)**

Printing from a Computer

38CS-031

You can print a document made with an application on your computer by using the printer driver. There are useful settings on the printer driver, such as enlarging/reducing, that enable you to print your documents in various ways. Before you can use this function, you need to complete some procedures, such as installing the printer driver on your computer. For more information, see the manuals for the relevant drivers on the online manual website.

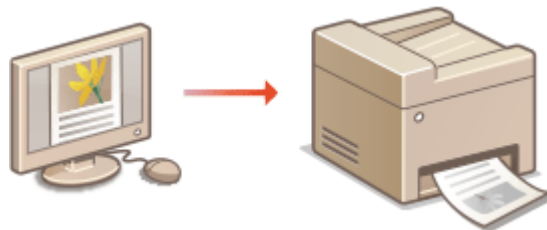

- ▶ **About the Printer Driver Help(P. 119)**
- ▶ **Basic Printing Operations(P. 119)**

About the Printer Driver Help

Clicking [Help] on the printer driver screen displays the Help screen. On this screen, you can see the detailed descriptions that are not in the User's Guide.

Basic Printing Operations

This section describes how to print a document on your computer by using the printer driver.

NOTE

Paper settings on the machine

- Normally, it is necessary to specify the paper size and type for the paper loaded in the drawer before proceeding to printing.

- 1 Open a document in an application and display the print dialog box.**
- 2 Select the printer driver for this machine, and click [Preferences] or [Properties].**
- 3 Specify the print settings as necessary, and click [OK].**
 - Switch the tab according to the settings.

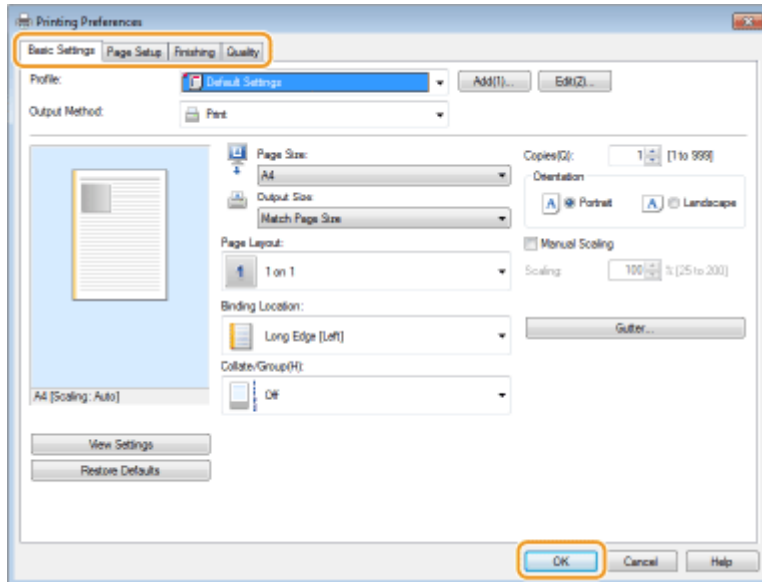

4 Click [Print] or [OK].

⇒ Printing starts.

- If you want to cancel printing, see [▶Canceling Prints\(P. 121\)](#) .

LINKS

- ▶[Checking the Printing Status and Log\(P. 123\)](#)

Canceling Prints

38CS-032

You can cancel printing from your computer or on the operation panel of the machine.

- ▶ From a Computer(P. 121)
- ▶ From the Operation Panel(P. 122)

From a Computer

You can cancel printing from the printer icon displayed on the system tray on the desktop.

1 Double-click the printer icon.



NOTE:

When the printer icon is not displayed

- Open the printer folder (▶ [Displaying the Printer Folder\(P. 338\)](#)), right-click the printer driver icon for this machine, and click [See what's printing] (or double-click the icon of the printer driver for this machine).

2 Select the document you want to cancel, and click [Document] ▶ [Cancel].

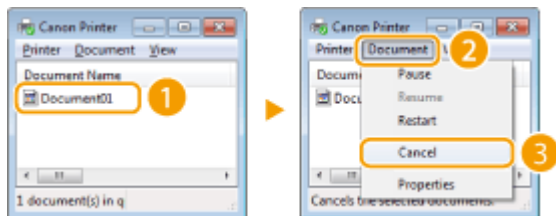

3 Click [Yes].

⇒ Printing of the selected document is canceled.

NOTE

- Several pages may be output after you cancel printing.

TIPS

Canceling from the Remote UI

- You can cancel printing from the [Job Status] page on the Remote UI: ▶ [Checking Current Status of Print Documents\(P. 201\)](#)

Canceling from an application

- On some applications, a screen like shown below appears. You can cancel printing by clicking [Cancel].

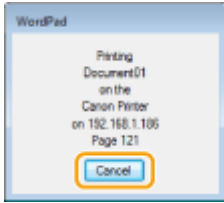

From the Operation Panel

Cancel printing using  or <Status Monitor>.

■ Press to Cancel

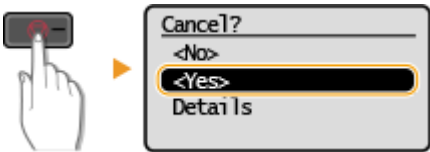

If the Screen Displays a List of Documents When is Pressed

Select the document you want to cancel, and select <Yes>.

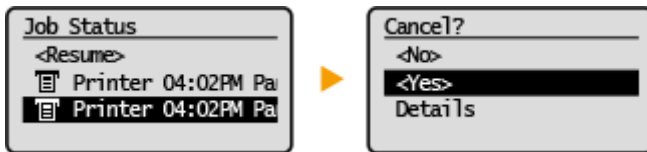

■ Check the Print Job Status Before Canceling



<Status Monitor> ▶ <Copy/Print Job> ▶ <Job Status> ▶ Select the document in the <Copy/Print Job Status> screen ▶ <Cancel> ▶ <Yes>

NOTE

- Several pages may be output after you cancel printing.

LINKS

- ▶ [Basic Printing Operations\(P. 119\)](#)
- ▶ [Checking the Printing Status and Log\(P. 123\)](#)

Checking the Printing Status and Log

38CS-033

You can check the current print statuses and the logs for printed documents.

IMPORTANT

- When <Display Job Log> is set to <Off>, you cannot check the print logs. **<Display Job Log>(P. 244)**

Useful in the Following Cases

- When your documents are not printed for a long time, you may want to see the waiting list of the documents waiting to be printed.
- When you cannot find your printouts that you thought had been printed, you may want to see whether an error has occurred.

1 Select <Status Monitor>.

2 Select <Copy/Print Job>.

3 Check the print statuses and logs.

■ To check the print statuses

- 1** <Job Status> ► Select the document whose status you want to check.

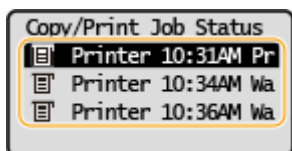

►► Displays detailed information about the document.

■ To check the print logs

- 1** <Print Job Log> ► Select the document whose log you want to check.
- <OK> is displayed when a document was printed successfully, and <Error> is displayed when a document failed to be printed because it was canceled or there was some error.

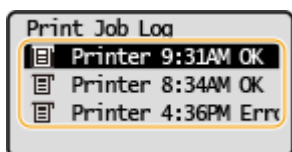

►► Displays detailed information about the document.

- The displayed document name or user name may not reflect the actual document or user name.

NOTE:

When a three-digit number is shown in the case of <Error>

- This number represents an error code. [▶Countermeasures for Each Error Code\(P. 305\)](#)

LINKS

- [▶Basic Printing Operations\(P. 119\)](#)
- [▶Canceling Prints\(P. 121\)](#)

Scanning

Scanning	126
Basic Operations for Scanning Originals	127
Scanning and Saving to a Computer	128
Scanning Using the Shortcut Key	130
Canceling Sending Documents	133
Using Your Computer to Scan (Remote Scan)	134
Scanning Documents from an Application	135
Using ScanGear MF	137

Scanning

38CS-034

You can scan original documents by using the operation panel of the machine or an application on a computer. Whichever way you use, the scanned originals are converted into electronic file formats such as PDFs. Use the scan function to convert large-volume paper documents into files so that you can organize them easily.

NOTE

- To use this machine as a scanner, you must complete preparations in advance, including installation of software to a computer. For more information, see the manuals for the relevant drivers or software on the online manual website. To connect the machine to your computer via a network, you must register the machine to the installed software. ▶ **Preparing to Use the Machine as a Scanner(P. 62)**
- Depending on the operating system and the version of the scanner driver or applications you are using, the screens in this manual may differ from your screens.

■ Using Basic Operations

You can scan and save originals to your computer by using the operation panel of the machine.

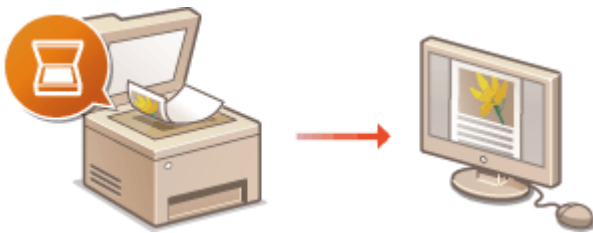

- ▶ **Basic Operations for Scanning Originals(P. 127)**
- ▶ **Canceling Sending Documents(P. 133)**

■ Scanning from a Computer

You can scan originals placed on the machine from a computer. The scanned originals are saved to the computer. You can scan using MF Scan Utility (included with the machine), or with other applications such as an image-processing or word-processing application.

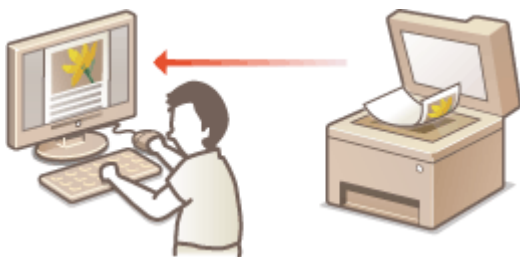

- ▶ **Using Your Computer to Scan (Remote Scan)(P. 134)**

Scanning from Mobile Devices

- Linking mobile devices such as smartphones or tablets to this machine provides a quick and easy way to scan originals set on this machine. ▶ **Linking with Mobile Devices(P. 139)**

Basic Operations for Scanning Originals

38CS-035

This section describes the basic procedures for scanning originals.

■ Scanning

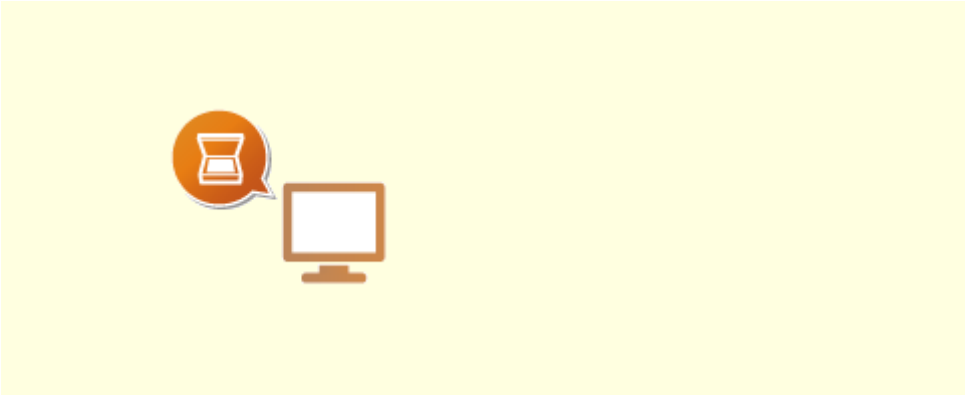

▶ **Scanning and Saving to a Computer(P. 128)**

■ Operating Jobs

▶ **Canceling Sending Documents(P. 133)**

Scanning and Saving to a Computer

38CS-036

The sequence of "scanning an original and saving it to a computer" can only be done when scanning from the machine. Scan while specifying what computer originals will be saved to; whether to scan originals in color or black and white; whether to save originals as PDFs or JPEGs; and other settings. Incidentally, if you want to specify a computer connected to the network as the destination, you must register the machine with the computer in advance (**▶Preparing to Use the Machine as a Scanner(P. 62)**).

1 Place the original(s). **▶Placing Originals(P. 84)**

2 Select <Scan> in the Home screen. **▶Home Screen(P. 78)**

3 Select <Computer>

- If only a computer connected to the machine via USB is used, proceed to step 5.

4 Select the destination computer.

5 Select the scan type.

- The scan types and settings that are displayed can be confirmed and changed by using MF Scan Utility. For more information, click [Instructions] on MF Scan Utility.

NOTE:

- If you are a macOS user, see the manuals for the relevant drivers or software on the online manual website.

6 Press **OK**.

⇒ Scanning of the original starts.

- If you want to cancel, see **▶Canceling Sending Documents(P. 133)** .

IMPORTANT:

- You cannot scan while the ScanGear MF is displayed. Close the screen before scanning.

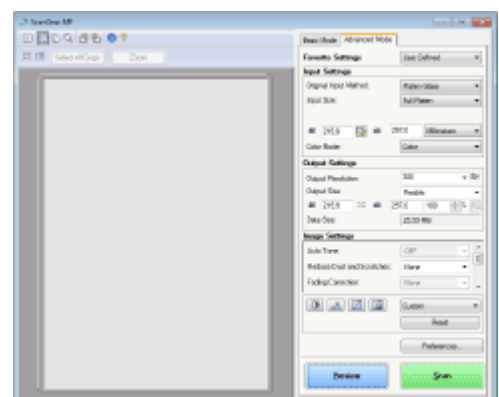

■ When scanning is complete

When scanning is complete, follow the procedure below (when the file format is PDF).

- 1 If there are additional pages of originals to be scanned, place the next original on the platen glass, and press .
 - Repeat this step until you finish scanning all of the pages.
 - When there is only one page to be scanned, proceed to the next step.
- 2 Select <Finish Scanning>.
 - ▣ The save destination folder is displayed on the computer.

NOTE

About the save destination folder

- By default, the scanned data is saved to the [My Documents] folder. A subfolder named with the scanning date is created, and the data is saved to that folder.
- You can change the save destination from the MF Scan Utility. For more information, click [Instructions] on MF Scan Utility.

Scanning Using the Shortcut Key

38CS-037

Place an original on the machine, and select <Scan> ► <Scan -> PC1> or <Scan -> PC2>, and scanning starts immediately. The type of scan (color or black and white), the save destination for the original, and other settings can be registered to the menu items, and originals can be scanned using those settings. This section describes how to register settings in the menu item and scan with it.

► **Registering Your Settings in the Shortcut Key(P. 130)**

► **Using the Shortcut Key(P. 131)**

Registering Your Settings in the Shortcut Key

Register the computer that scanned images are saved in and the type of scan to the shortcut key.

- 1** Select <Menu> in the Home screen. ► **Home Screen(P. 78)**
- 2** Select <Scan Settings>.
- 3** Select <Shortcut Key Settings> ► <Register>.
- 4** Select the shortcut key to which you want to register settings.
- 5** Select the type of connection that is used between the machine and computer.

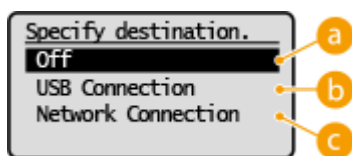

a <Off>

Select this setting to erase registered settings.

b <USB Connection>

Select this setting if the machine and computer are connected via USB.

c <Network Connection>

Select this setting if the machine and computer are connected via a network.

6 Select the destination computer.

- This screen is not displayed if you select <USB Connection> in step 5.

7 Select the scan type.

- The scan types and settings that are displayed can be confirmed and changed by using MF Scan Utility. For more information, click [Instructions] on MF Scan Utility.

NOTE:

- If you are a macOS user, see the manuals for the relevant drivers or software on the online manual website.

■ **Checking the Registered Settings**



<Menu> ▶ <Scan Settings> ▶ <Shortcut Key Settings> ▶ <Confirm Destination> ▶ Select shortcut key

Using the Shortcut Key

1 Place the original(s). ▶ **Placing Originals(P. 84)**

2 Select <Scan> in the Home screen. ▶ **Home Screen(P. 78)**

3 Select <Scan -> PC1> or <Scan -> PC2>.

- To check the settings registered in the key, see ▶ **Checking the Registered Settings(P. 131)** .
- Scanning starts.
- To cancel, see ▶ **Canceling Sending Documents(P. 133)** .

IMPORTANT:

- You cannot scan while the ScanGear MF is displayed. Close the screen before scanning.

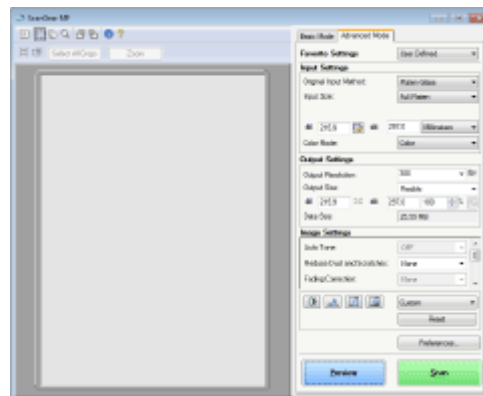

■ **When scanning is complete**

When scanning is complete, follow the procedure below (when the file format is PDF).

- 1** If there are additional pages of originals to be scanned, place the next original on the platen glass, and press  .
 - Repeat this step until you finish scanning all of the pages.
 - When there is only one page to be scanned, proceed to the next step.
- 2** Select <Finish Scanning>.

▣▣▣▣ The save destination folder is displayed on the computer.

NOTE

About the save destination folder

- By default, the scanned data is saved to the [My Documents] folder. A subfolder named with the scanning date is created, and the data is saved to that folder.
- You can change the save destination from the MF Scan Utility. For more information, click [Instructions] on MF Scan Utility.

Canceling Sending Documents

If you want to cancel sending documents immediately after starting scan, select <Cancel> on the display or press . You can also cancel sending documents after checking the sending status.

■ Select <Cancel> to cancel



■ Press to cancel

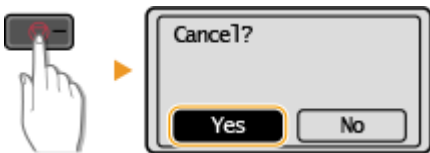

If the screen displays a list of documents when is pressed

Originals have been scanned and are waiting to be processed. Select the document to cancel, and select <Yes>.



LINKS

- ▶ Basic Operations for Scanning Originals(P. 127)

Using Your Computer to Scan (Remote Scan)

38CS-039

To scan from a computer, you can use MF Scan Utility or an application such as an image processing or word processing application. If you use ScanGear MF supplied with the machine, you can configure advanced scan settings ([Using ScanGear MF\(P. 137\)](#)).

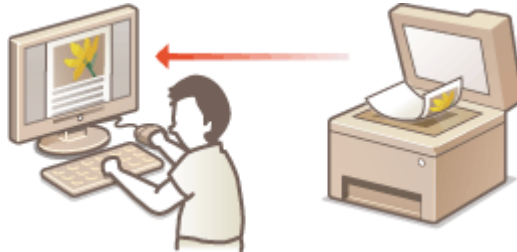

Scanning Using MF Scan Utility



MF Scan Utility is an application included with the machine that enables you to scan documents or images to a computer. You can forward the scanned data to a specified application, or attach it to an e-mail message. For more information, click [Instructions] on MF Scan Utility.

NOTE

- If you are a macOS user, see the manuals for the relevant drivers or software on the online manual website.

Scanning Using an Application



You can scan images by using an application such as a word-processing or image-processing application, and load the images directly into the application. You do not need to start another application to scan. [Scanning Documents from an Application\(P. 135\)](#)

Scanning Documents from an Application

38CS-03A



You can scan originals from applications such as image-processing or word-processing software. The scanned image is directly loaded in the application, allowing you to edit or process the image immediately. The following procedure varies depending on the application.

IMPORTANT

- The application must be compatible with TWAIN or WIA*. For more information, see the instruction manual for your application.

*TWAIN is a standard for connecting image input devices, such as scanners, with computers. WIA is a function that is an integrated standard in Windows.

1 Place the original(s). Placing Originals(P. 84)

IMPORTANT:

- The second or subsequent originals may not be scanned, or an error message may be displayed depending on the application. In such a case, place and scan one original at a time.
- When <Auto Online for Remote Scan> is set to <Off>, you must select <Scan> <Remote Scanner> in the Home screen to bring the machine online. <Auto Online for Remote Scan>(P. 244)

2 From the application, select the start scan command.

- The procedure for selecting the start scan command varies depending on the application. For more information, see the instruction manual for your application.

3 Select the scanner driver for this machine.

- Select ScanGear MF or WIA. If you select ScanGear MF, you can configure advanced scan settings.

4 Specify the scanning settings as necessary.

5 Click [Scan].

⇒ Scanning of the original starts.

- When scanning is complete, the scanned image is forwarded to an application.

How to use ScanGear MF

- Click on the ScanGear MF screen, and see the Help.

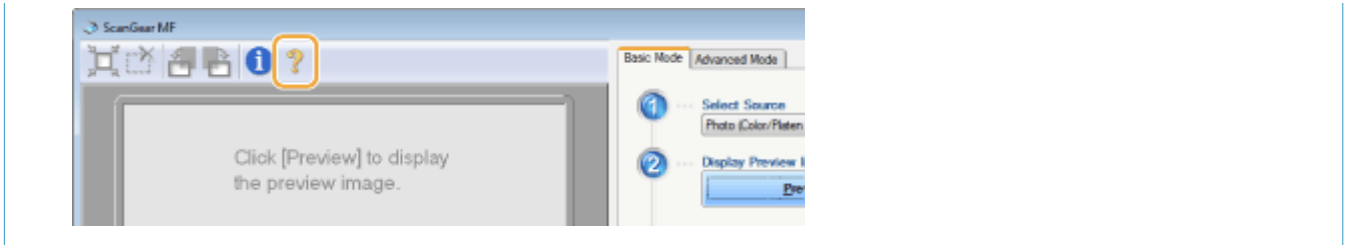

LINKS

▶ **Using ScanGear MF(P. 137)**

Using ScanGear MF

38CS-03C



ScanGear MF is a scanner driver included with the machine. You can use ScanGear MF to configure advanced scan settings when you scan. The way of starting ScanGear MF differs depending of the way of scanning from the computer.

Starting from MF Scan Utility

When scanning from MF Scan Utility, click [ScanGear] to start ScanGear MF. For more information, click [Instructions] on MF Scan Utility.

NOTE

- If you are a macOS user, see the manuals for the relevant drivers or software on the online manual website.

Starting from an application

To scan from applications such as image-processing or word-processing software, select ScanGear MF as scanner driver. **☞ Scanning Documents from an Application(P. 135)**

TIPS

Functions of ScanGear MF

- Previewing the image before scanning
- Specifying the scanning area
- Adjusting the detailed image quality

How to use ScanGear MF

- Click  on the ScanGear MF screen, and see the Help.

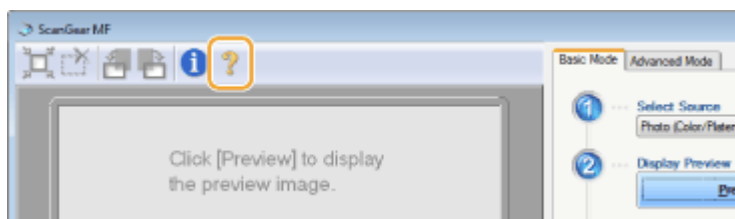

Linking with Mobile Devices

Linking with Mobile Devices	139
Connecting with Mobile Devices	140
Connecting via a Wireless LAN Router (LAN Connection)	141
Connecting Directly (Access Point Mode)	142
Utilizing the Machine through Applications	145
Using AirPrint	146
Printing with AirPrint	151
Scanning with AirPrint	154
If AirPrint Cannot Be Used	156
Using Google Cloud Print	157
Managing the Machine by the Remote Control	159

Linking with Mobile Devices

38CS-03E

Linking the machine with mobile devices such as smart phones and tablets enables you to use an appropriate application to perform printing, or other operation with ease. In addition, you can operate the machine from mobile devices via remote control to confirm printing status and change the settings of the machine.



- ▶ **Connecting with Mobile Devices(P. 140)**
- ▶ **Connecting Directly (Access Point Mode)(P. 142)**
- ▶ **Utilizing the Machine through Applications(P. 145)**
- ▶ **Using AirPrint(P. 146)**
- ▶ **Using Google Cloud Print(P. 157)**
- ▶ **Managing the Machine by the Remote Control(P. 159)**

IMPORTANT

- Depending on your mobile device, the machine may not operate correctly.

Connecting with Mobile Devices

38CS-03F

There are two methods used to connect a mobile device with the machine: connecting via a wireless LAN router, and communicating wirelessly and directly with the machine. Select a connection method in accordance with the communication environment and the device you are using.

■ Connecting via a Wireless LAN Router

Just as connecting a computer to the machine, connect a mobile device to the machine via a wireless LAN router. ▶ **Connecting via a Wireless LAN Router (LAN Connection)(P. 141)**



■ Connecting Directly

Directly connect a mobile device to the machine wirelessly without using wireless LAN. It is possible to immediately connect to the machine wirelessly even outside of a wireless LAN environment. ▶ **Connecting Directly (Access Point Mode)(P. 142)**



Connecting via a Wireless LAN Router (LAN Connection)

38CS-03H

If a wireless LAN router is connected to the network connected to the machine, you can establish a communication with a mobile device via the wireless LAN router in the same way for a computer. For information about how to connect a mobile device to your wireless LAN router, see the instruction manuals for your networking devices or contact your manufacturer. Connect the machine to a router via the wired or wireless LAN. **▶Setting Up the Network Environment(P. 11)**



NOTE

- If your mobile devices do not support IPv6, use the IPv4 address. **▶Setting IPv4 Address(P. 28)**

1 Select <Status Monitor> in the Home screen. **▶Home Screen(P. 78)**

2 Select <Network Information>.

3 Display the IP address of the machine.

■IPv4

- Select <IPv4> ▶ <IP Address>.

■IPv6

- Select <IPv6> ▶ <Link-Local Address> ▶ <IP Address>.

4 Connect from the mobile device to the IP address that appears on the screen.

Connecting Directly (Access Point Mode)

38CS-03J

Even in an environment without a wireless LAN router, using "Access Point Mode," which can directly connect a mobile device to the machine wirelessly, enables you to connect the mobile device on hand to the machine without difficult settings.



▶ **Preparing for Direct Connection (Access Point Mode)(P. 142)**

▶ **Connecting Directly(P. 143)**

Preparing for Direct Connection (Access Point Mode)

Establish a connection by using Access Point Mode in the following order.



Check the network settings of the machine.

- Set the IPv4 address. ▶ **Setting IPv4 Address(P. 28)**



Preparing the mobile device

- Configure settings to connect the mobile device to Wi-Fi.



Put the machine into the connection standby status.

- <Menu> ▶ <Network Settings> ▶ <Direct Connection Settings> ▶ set <Use Direct Connection> to <On>.

■ If connected to the network by wireless LAN

Items for selecting the Direct Connection method is displayed.

<Direct Connection Only>

Connection by wireless LAN becomes unavailable. Select when only using Direct Connection.

<Wireless LAN/Direct Conn. (Auto Switch)>

The wireless LAN connection is disabled while the direct connection is active. The machine automatically switches to wireless LAN connection when the

direct connection is terminated. This option is selected when you want to switch between direct connection and wireless LAN connection.

NOTE

Specifying the value for time until auto termination

- You can specify the time to automatically establish a disconnection when the direct connection is enabled. ▶ **<Time Until Direct Connection Termination>(P. 216)**

Connecting multiple mobile devices at the same time

- Configure the machine's SSID and network key arbitrarily. The network key can be left blank. ▶ **<Access Point Mode Settings>(P. 216)**

Connecting Directly

IMPORTANT

- It may take time until a connection of the machine and the mobile device is established.

1 Select **<Direct Connection>** in the Home screen. ▶ **Home Screen(P. 78)**

- If a message appears, continue by following the instructions on the screen.

2 Select **<Display SSID/Network Key>**.

3 Configure the Wi-Fi settings from the mobile device using the SSID and network key information that appear on the display.

4 When the target operation is completed, press **OK**, then select **<Disconnect>** ▶ **<Yes>**.

TIPS

- Select **<Connection Information>** on the screen under the direct connection to check the connected mobile device.

IMPORTANT

- While connecting via direct connection, you may not be able to connect to the Internet depending on the mobile device you are using.
- If a wireless connection from the mobile device is not performed within 5 minutes while the SSID and network key are displayed, the connection waiting state terminates.
- If the status without data transmission between the mobile device and the machine continues during communication by direct connection, the communication may end.
- Power saving performance of sleep mode degrades while connecting via direct connection.

- When you finish the desired operation, be sure to terminate the connection between the machine and the mobile device. If they remain connected, power saving performance of sleep mode degrades.
- If you use the direct connection, do not set the IP address manually on the mobile device. Doing so may prevent proper communication after using the direct connection.

Utilizing the Machine through Applications

38CS-03K

Perform printing and other operations from the mobile device connected to the machine using applications. Various applications including those exclusive to Canon are supported. Use properly in accordance with your device, the application, and the situation.

■ Using Canon PRINT Business

This application is used to perform printing and other operations from mobile devices that support iOS/Android. When printing, it is not necessary to perform operations on the machine. For more information on supported operating systems, detailed setting methods, and operations, see the application's Help or the Canon website (<http://www.canon.com/gomp/>).

IMPORTANT

- You can download Canon PRINT Business for free, but you will be charged the Internet connection fee.

■ Printing with Canon Print Service

You can easily print from the menu of applications that support the Android print subsystem. For more information on supported operating systems and detailed settings and procedures, see the Canon website (<http://www.canon.com/>).

■ Printing by Mopria®

The machine also supports Mopria®. Using Mopria® enables you to print from mobile devices that support Android using common operations and settings, even if manufacturers and models differ. For example, if you are using printers supporting Mopria® made by multiple manufacturers or a printer supporting Mopria® that is located in a place you are visiting, you can print without installing an application exclusive for each manufacturer or model. For more information on supporting models or operation environments, see <http://www.mopria.org>.



■ Printing with Google Cloud Print

You can use applications and services which support Google Cloud Print to print from a computer or mobile device without using a printer driver. ▶ **Using Google Cloud Print(P. 157)**

Using AirPrint

This section describes the settings required to use AirPrint and the procedures to be performed using Apple devices.



AirPrint Settings

- ▶ [Configuring AirPrint Settings\(P. 146\)](#)
- ▶ [Displaying the Screen for AirPrint\(P. 149\)](#)

Functions of the AirPrint

- ▶ [Printing with AirPrint\(P. 151\)](#)
- ▶ [Scanning with AirPrint\(P. 154\)](#)

Troubleshooting

- ▶ [If AirPrint Cannot Be Used\(P. 156\)](#)

Configuring AirPrint Settings

You can register information, including the name of the machine and installation location, that is used for identifying the machine. You can also disable the AirPrint function of the machine. Use the Remote UI to change these settings.

NOTE

- For more information about the basic operations to be performed when setting the machine from the Remote UI, see [▶Setting Up Menu Options from Remote UI\(P. 205\)](#) .

- 1** Start the Remote UI and log in to System Manager Mode. [▶Starting Remote UI\(P. 198\)](#)
- 2** Click [Settings/Registration] on the Portal page. [▶Remote UI Screen\(P. 199\)](#)
 - If you are using a mobile device, such as an iPad, iPhone, or iPod touch, read "click" as "tap" in this section.
- 3** Select [Network Settings] ▶ [AirPrint Settings].
- 4** Click [Edit].
- 5** Specify the required settings.

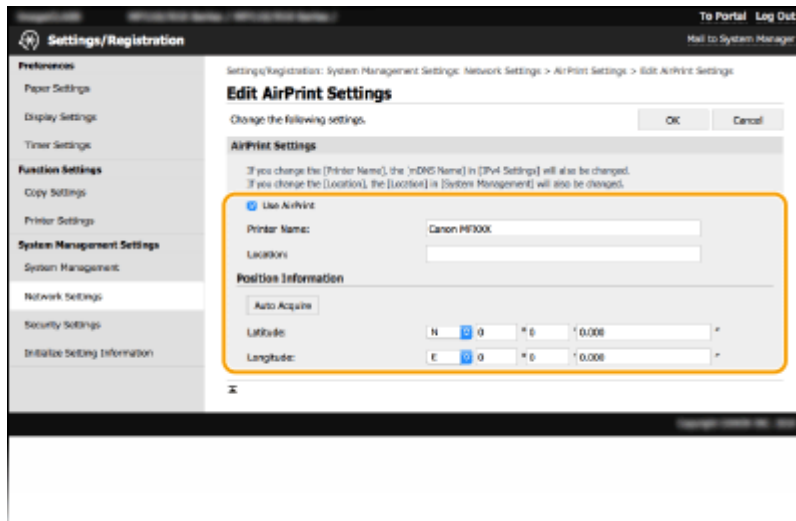
**[Use AirPrint]**

Select the check box to enable AirPrint. To disable AirPrint, clear the check box.

[Printer Name]

Enter the name of the machine. If an mDNS name has already been registered in [mDNS Settings] ([▶ Configuring DNS\(P. 51\)](#)), the registered name is displayed.

[Location]

Enter the location of the machine. If a location has already been registered in [Device Information] ([System Management] in [System Management Settings] (Settings/Registration)), the registered name is displayed.

[Latitude]

Enter the latitude of the location where the machine is installed.

[Longitude]

Enter the longitude of the location where the machine is installed.

6 Click [OK].**IMPORTANT**

If you select [Use AirPrint], the following settings are set to on.

- <Use HTTP>
- [IPP Print Settings]
- [Use mDNS] (IPv4 Settings)
- [Use mDNS] (IPv6 Settings)
- <Network Link Scan Settings>

NOTE

- If you change [Printer Name] that you have once specified, you may be unable to print any more from the Mac that has been able to be used for printing so far. This phenomenon occurs because [mDNS Name] ([▶ Configuring DNS\(P. 51\)](#)) of IPv4 is also changed automatically. In this case, add the machine to the Mac again.
- Entering the printer name makes it easier to identify multiple printers that support AirPrint.

■ Changing the Setting of Functions Available with AirPrint

If you want to disable functions that you are not going to use with AirPrint or encrypt communications, configure the necessary setting using the operation panel or Remote UI.

Changing Print Settings

To perform printing with AirPrint, IPP protocol is used.

Turning the Function On/Off

You can specify whether to perform printing with AirPrint. The factory default setting is [On].



Log in to the Remote UI in System Manager Mode (▶ **Starting Remote UI(P. 198)**) ▶ [Settings/Registration] ▶ [Network Settings] ▶ [TCP/IP Settings] ▶ [Edit] in [IPP Print Settings] ▶ Clear or select the [Use IPP Printing] check box ▶ [OK]

Changing the TLS Setting

You can specify whether to encrypt communications using TLS when performing printing with AirPrint. The factory default setting is [On].



Log in to the Remote UI in System Manager Mode (▶ **Starting Remote UI(P. 198)**) ▶ [Settings/Registration] ▶ [Network Settings] ▶ [TCP/IP Settings] ▶ [Edit] in [IPP Print Settings] ▶ Clear or select the [Use TLS] check box ▶ [OK]

Changing the Scan Setting

Configure the scan setting using AirPrint.

Set the Function to Enable or Disable

You can turn on/off the scan function available with AirPrint. The factory default setting is <On>.



<Menu> ▶ <Network Settings> ▶ <TCP/IP Settings> ▶ <Network Link Scan Settings> ▶ Set <Use Network Link Scan> to <Off> or <On>

Change TLS Settings

You can specify whether or not to encrypt TLS communications when scanning data using AirPrint. The factory default setting is <On>.



<Menu> ▶ <Network Settings> ▶ <TCP/IP Settings> ▶ <Network Link Scan Settings> ▶ Set <Use TLS> to <Off> or <On>

Displaying the Screen for AirPrint

You can display the screen for AirPrint, on which you can not only access the AirPrint Settings but also view information about consumables, such as paper and toner cartridge, etc. Further, you can configure security function settings.

1 Select [System Preferences] ▶ [Printers & Scanners], then add the machine to the Mac you are using.

- If the machine has already been added, this operation is not required.

2 Select this machine from the list of printers in [Printers & Scanners].

3 Click [Options & Supplies].

4 Click [Show Printer Webpage].

5 Log in to the Remote UI.

- To change the AirPrint settings, it is necessary to log in as an administrator.

■ AirPrint-Dedicated Page

When you log in with administrator privileges, the AirPrint-dedicated page is displayed as shown below.

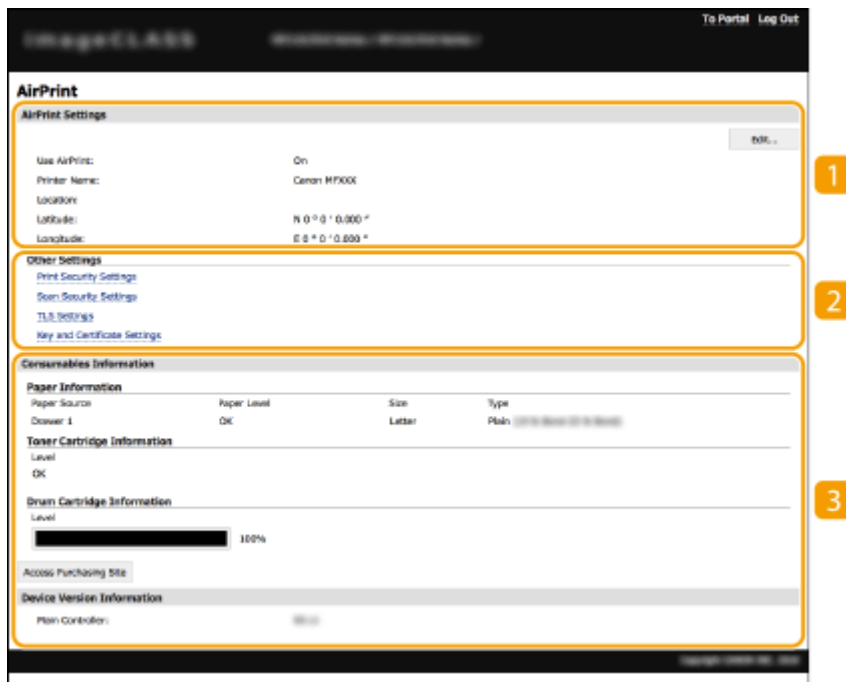

1 [AirPrint Settings]

Enables you to check the values entered in the AirPrint settings, such as the name and location of the machine. You can click [Edit] to change the settings.

2 [Other Settings]

[Print Security Settings]

Configure the print security settings using TLS or authentication.

[Scan Security Settings]

Configure the scan security settings using TLS.

[TLS Settings]

Enables you to change the key and certificate used for TLS. ▶ **Configuring the Key and Certificate for TLS(P. 179)**

[Key and Certificate Settings]

Enables you to generate and install a key and certificate, or request a certificate to be issued. ▶ **Configuring the Key and Certificate for TLS(P. 179)**

3 [Consumables Information]

Enables you to check the information of a paper source and consumables of the machine and the device version.

Trademarks

Apple, Bonjour, iPad, iPhone, iPod touch, Mac, macOS, OS X and Safari are trademarks of Apple Inc., registered in the U.S. and other countries. AirPrint and the AirPrint logo are trademarks of Apple Inc.

Printing with AirPrint

You can print from an iPad, iPhone, iPod touch, or Mac without using a printer driver.



▶ **Printing from an iPad, iPhone, or iPod touch(P. 151)**

▶ **Printing from a Mac(P. 152)**

System Requirements

One of the following Apple devices is required to print with AirPrint.

- iPad (all models)
- iPhone (3GS or later)
- iPod touch (3rd generation or later)
- Mac (Mac OS X 10.7 or later)*

*OS X v10.9 or later when using a USB connection

Network Environment

One of the following environments is required.

- An environment where an Apple device and the machine are connected to the same LAN
- An environment where an Apple device and the machine are connected directly
- An environment where a Mac is connected to the machine via USB

IMPORTANT

- For printing, it is required to set [Use IPP Printing] to [On]. ▶ **Changing the Setting of Functions Available with AirPrint(P. 148)**

Printing from an iPad, iPhone, or iPod touch

1 Make sure that the machine is turned ON and connected to the Apple device.

- For how to make sure of this, see ▶ **Setting Up the Network Environment(P. 11)** .
- For information on the Direct Connection, see ▶ **Connecting Directly (Access Point Mode)(P. 142)** .

2 From the application on your Apple device, tap  to display the menu options.

3 Tap [Print].**4 Select this machine from [Printer].**

- The printers connected to the network are displayed here. Select this machine in this step.

IMPORTANT:

- The screen for selecting this machine in [Printer] is not displayed on applications that do not support AirPrint. You cannot print by using those applications.

5 Specify the print settings as necessary.**NOTE:**

- The available settings and paper sizes differ depending on the application you are using.

6 Tap [Print].

▣▣▣ Printing starts.

NOTE:**Checking the print status**

- During printing, press the Home button of the Apple device twice ► tap [Print].

Printing from a Mac

1 Make sure that the machine is turned ON and connected to the Mac.

- For how to make sure of this, see [▶Setting Up the Network Environment\(P. 11\)](#) .

2 Add the machine to the Mac from [System Preferences] ► [Printers & Scanners].

- If the machine has already been added, this operation is not required.

3 Open a document in an application and display the print dialog box.

- How to display the print dialog box differs for each application. For more information, see the instruction manual or Help for the application you are using.

4 Select the machine in the print dialog box.

- The printers connected to the Mac are displayed. Select this machine in this step.

5 Specify the print settings as necessary.

NOTE:

- The available settings and paper sizes differ depending on the application you are using.

6 Click [Print].

▣▶ Printing starts.

Scanning with AirPrint

38CS-03S

You can use AirPrint to transfer the data scanned by the machine directly to a Mac.

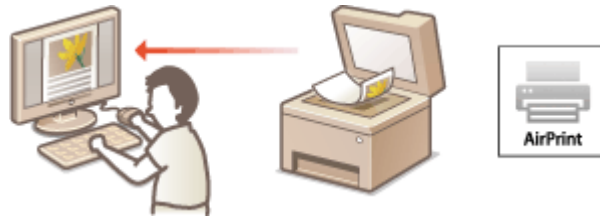

System Requirements

To scan with AirPrint, you need a Mac with OS X 10.9 or later installed. To scan using TLS, you need a Mac with OS X 10.11 or later installed.

Network Environment

One of the following environments is required.

- An environment where an Apple device and the machine are connected to the same LAN
- An environment where a Mac is connected to the machine via USB

IMPORTANT

- For scanning, it is required to set <Use Network Link Scan> to <On>. **▶ Changing the Setting of Functions Available with AirPrint(P. 148)**
- Before scanning, it is required to put the machine into online state. When the auto online function (**▶ <Auto Online for Remote Scan>(P. 244)**) is set to <Off>, first put the machine into online state by selecting <Scan> ▶ <Remote Scanner>, then start the procedure for scanning.
- You cannot scan while settings for operations are being made, or while the machine is performing any operation whatsoever.

Scanning from a Mac

- 1 Make sure that the machine is turned ON and connected to the Mac.**
 - For how to make sure of this, see **▶ Setting Up the Network Environment(P. 11)** .
- 2 Add the machine to the Mac from [System Preferences] ▶ [Printers & Scanners].**
 - If the machine has already been added, this operation is not required.
- 3 Select this machine from the list of printers in [Printers & Scanners].**
- 4 Click [Scan].**

5 Click [Open Scanner].

⇒ The [Scanner] screen is displayed.

6 Configure the scan settings as necessary.

7 Click [Scan].

⇒ The original is scanned, and the image is displayed.

If AirPrint Cannot Be Used

38CS-03U

If AirPrint cannot be used, try taking the following solutions.

- Make sure that the machine is turned ON. If the machine is turned ON, first turn it OFF, then wait for at least 10 seconds and then turn it back ON to check if the problem is solved.
- Make sure that no error messages are displayed on the machine.
- Make sure that Apple devices and the machine are connected to the same LAN. If the machine is turned ON, it may take several minutes before the machine is ready for communication.
- Make sure that Bonjour on your Apple device is enabled.
- For printing, make sure that the paper is loaded in the machine and that the machine contains a sufficient amount remaining in the toner cartridge and the drum cartridge. **▶ Displaying the Screen for AirPrint(P. 149)**
- For scanning, make sure that the machine's setting for Network Link Scan is <On>. **▶ Changing the Setting of Functions Available with AirPrint(P. 148)**

Using Google Cloud Print

38CS-03W

Google Cloud Print is a service that enables a user with a Google account to print from a smartphone, tablet, or computer connected to the Internet using applications compatible with Google Cloud Print. Unlike conventional printing from a computer, it does not require a printer driver.



- ▶ **Checking the Settings of the Machine(P. 157)**
- ▶ **Registering the Machine with Google Cloud Print(P. 157)**

IMPORTANT

- An environment in which you can connect to the internet is required when registering the machine and when printing using Google Cloud Print. In addition, the customer is responsible for any fees regarding internet connection.
- Google Cloud Print may not be available, depending on your country or region.

NOTE

- A Google account is required to use Google Cloud Print. If you do not have a Google account, create one on the Google website.

Checking the Settings of the Machine

Check the following before configuring cloud printing.

- Make sure that the IPv4 address or IPv6 address is specified for the machine, and that the machine is able to communicate with computers on a network.
 - ▶ **Connecting to a Wired LAN(P. 14)**
 - ▶ **Connecting to a Wireless LAN(P. 15)**
- Check whether the date and time of the machine are specified correctly. ▶ **Setting the Date/Time(P. 9)**

Registering the Machine with Google Cloud Print

Registering the machine with Google Cloud Print enables you to print from anywhere using the service.

NOTE

- For more information about the basic operations to be performed when setting the machine from the Remote UI, see ▶ **Setting Up Menu Options from Remote UI(P. 205)** .

- 1 Start the Remote UI and log in as an administrator. ▶ Starting Remote UI(P. 198)
- 2 Click [Settings/Registration] on the Portal page. ▶ Remote UI Screen(P. 199)
- 3 Select [Network Settings] ▶ [Google Cloud Print Settings].
- 4 Click [Edit] for [Basic Settings].
- 5 Select the [Use Google Cloud Print] check box ▶ [OK].
- 6 Click [Register] in [Registration Status].

NOTE:**Re-Registering the Machine**

- To re-register the machine, delete its registration before registering it again.

- 7 Click the URL link displayed for [URL for Registration].
- 8 Follow the instructions on the screen to register the machine.

⇒ Printing can now be performed from applications that support Google Cloud Print, such as Google Chrome™.

NOTE:

- For information on the latest applications that support Google Cloud Print, check the Google Cloud Print home page.

NOTE**Configuring Settings on the Operation Panel**

- You can also enable or disable the Cloud Print function from <Menu> in the Home screen. ▶ <Google Cloud Print Settings>(P. 246)

Registering from a Mobile Device or Google Chrome

- You can register the machine from a mobile device or Google Chrome. The machine's display shows the confirmation screen before completion of the registration. Select <Yes> to complete the registration.
- For information on registration methods, see the manual of your device or the Google Cloud Print website.

Managing the Machine by the Remote Control

38CS-03X

You can use the Remote UI from a smart phone or tablet Web browser. You can confirm the machine status or perform various settings from a mobile device.



Supported Web Browsers

Web browsers supporting the Remote UI for mobile devices are the following.

Android OS

- Chrome

iOS

- Safari

Starting the Remote UI from Mobile Devices

Enter the IP address of the machine on the Web browser to start the Remote UI. Prior to operation, confirm the IP address set for the machine ([Viewing Network Settings\(P. 34\)](#)). If it is unknown, ask your network administrator.

1 Start the Web browser of the mobile device.

2 Enter "http://<the IP address of the machine>/" in the address entry column.

- If you want to use an IPv6 address, enclose the IPv6 address with brackets.
Example: http://[fe80::2e9e:fcff:fe4e:dbce]/

NOTE:

- For a "Smartphone Version" of the Remote UI, a portion of items displayed are omitted. If you want to confirm all of the items, see the "PC Version."

LINKS

[Managing the Machine from a Computer \(Remote UI\)\(P. 197\)](#)

Managing the Machine

Managing the Machine	161
Setting Access Privileges	163
Setting the System Manager PIN	164
Setting a Remote UI PIN	166
Configuring the Network Security Settings	168
Restricting Communication by Using Firewalls	170
Specifying IP Addresses for Firewall Settings	171
Specifying MAC Addresses for Firewall Settings	174
Changing Port Numbers	176
Setting a Proxy	177
Configuring the Key and Certificate for TLS	179
Generating the Key and Certificate for Network Communication	181
Generating a Key and Certificate Signing Request (CSR)	184
Registering the Key and Certificate for Network Communication	187
Configuring IEEE 802.1X Authentication Settings	189
Restricting the Machine's Functions	193
Restricting USB Functions	194
Disabling HTTP Communication	195
Disabling Remote UI	196
Managing the Machine from a Computer (Remote UI)	197
Starting Remote UI	198
Checking the Status and Logs	201
Setting Up Menu Options from Remote UI	205
Updating the Firmware	208
Initializing Settings	210

Managing the Machine

38CS-03Y

To reduce the various risks associated with the use of this machine, such as leaks of personal information or unauthorized use by third parties, constant and effective security measures are required. An administrator should manage important settings, such as access privileges and security settings, to ensure that the machine is used safely.

■ Configuring the Basic Management System



▶ **Setting Access Privileges(P. 163)**

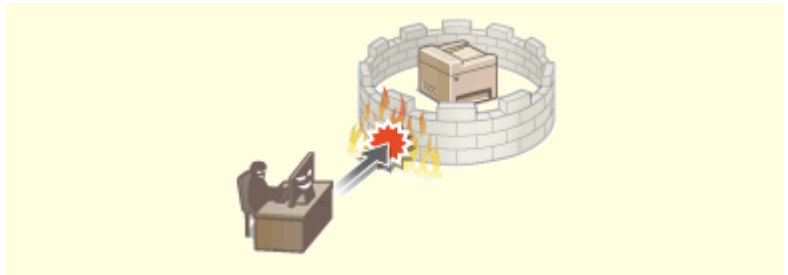

▶ **Configuring the Network Security Settings(P. 168)**

■ Preparing for Risks from Negligence or Misuse

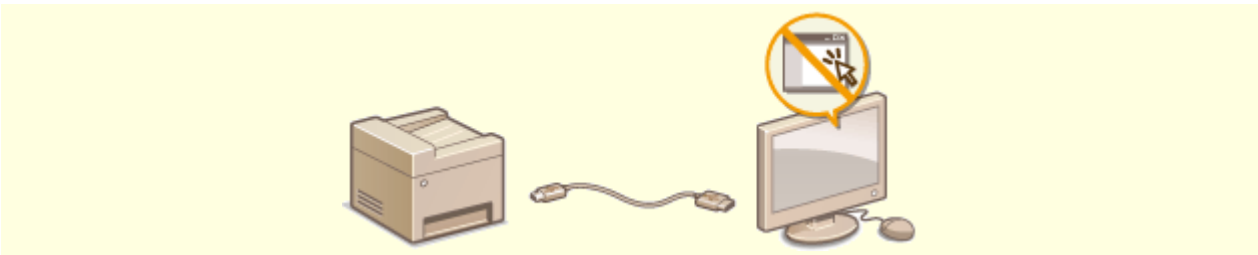

▶ **Restricting the Machine's Functions(P. 193)**

■ Ensuring Effective Management



▶ **Managing the Machine from a Computer (Remote UI)(P. 197)**

■ Managing the System Configuration and Settings



▶ **Updating the Firmware(P. 208)**

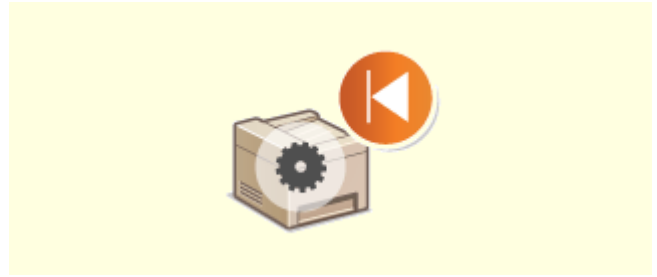

▶ **Initializing Settings(P. 210)**

Setting Access Privileges

38CS-040

Protect the machine from unauthorized access by only allowing users with access privileges to use the machine. When privileges are set, the user must enter a PIN to change settings or access the Remote UI.



Access privileges are divided into two types: System Manager Mode and General User Mode. System Manager Mode has full access privileges, and a System Manager PIN can be set to restrict logon in this mode. And by setting a Remote UI Access PIN, you can restrict use of the Remote UI in General User Mode and in System Manager Mode without a System Manager PIN set.

System Manager PIN

System Manager PIN is intended exclusively for Administrators having full access privileges. If you specify this PIN, you need to log on to the machine using this PIN in order to access <Network Settings> or <System Management Settings>. Set the System Manager PIN when you need different access privilege levels for administrators and general users. [▶Setting the System Manager PIN\(P. 164\)](#)

Remote UI PIN (Remote UI Access PIN)

This is a PIN for using the Remote UI. Only users who know the PIN can access the Remote UI. [▶Setting a Remote UI PIN\(P. 166\)](#)

Setting the System Manager PIN

38CS-041

Set a System Manager PIN that is intended exclusively for Administrators. You can access <Network Settings>, <System Management Settings>, etc. only when the PIN has been entered correctly. It is recommended that only Administrators know the PIN.

- 1 Select <Menu> in the Home screen. [▶Home Screen\(P. 78\)](#)
- 2 Select <System Management Settings>.
- 3 Select <System Manager Information Settings> ▶ <System Manager PIN>.
- 4 Press **OK**.
- 5 Specify the System Manager PIN.

- Enter a number of up to seven digits, and select <Apply>.
- When <PIN (Confirm)> is displayed, enter the PIN once again to confirm.

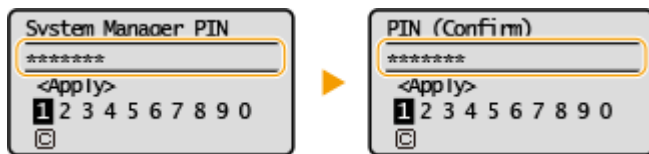

NOTE:

- You cannot set a PIN that consists only of zeros, such as "00" or "0000000."
- To disable the PIN, select  to leave the text box blank, and then select <Apply>.

■Setting the System Manager Name

- 1 Select <System Manager Name>.
- 2 Enter the System Manager Name, and select <Apply>.
 - On how to enter text, see [▶Entering Text\(P. 83\)](#) .

IMPORTANT

- Do not forget your PIN. If you forget your PIN, contact your local authorized Canon dealer or the Canon help line.

NOTE

Configuring settings via the Remote UI

- Start the Remote UI and log in to System Manager Mode. Click [Settings/Registration] ▶ [System Management] ▶ [Edit] and specify the necessary settings on the displayed screen.
- By using the Remote UI, you can register a variety of information, including contact information, Administrator comments, the installation location of the machine, as well as the settings that you can register by using the operation panel. The registered information can be viewed on the [Device Information] page of the Remote UI. ▶ **Checking System Manager Information(P. 203)**

If a System Manager PIN is Set

- If you try to access <Network Settings> or <System Management Settings>, the following screen is displayed. Enter the set PIN.
- Entering a PIN is also required when logging on in System Manager Mode in the Remote UI. ▶ **Starting Remote UI(P. 198)**

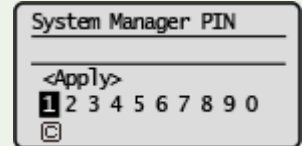

LINKS

- ▶ **Setting Access Privileges(P. 163)**

Setting a Remote UI PIN

38CS-042

You can set a PIN for access to the Remote UI. All users use a common PIN.

NOTE

- For more information about the basic operations to be performed when setting the machine from the Remote UI, see [▶Setting Up Menu Options from Remote UI\(P. 205\)](#) .

- 1 Start the Remote UI and log in to System Manager Mode. ▶Starting Remote UI(P. 198)**
- 2 Click [Settings/Registration] on the Portal page. ▶Remote UI Screen(P. 199)**
- 3 Select [Security Settings] ▶ [Remote UI Settings].**
- 4 Click [Edit].**
- 5 Select the [Use Remote UI Access PIN] check box and set the PIN.**

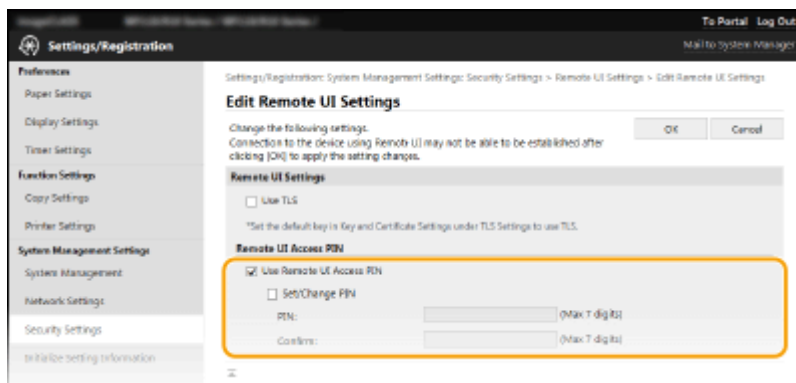

[Use Remote UI Access PIN]

If you select the check box, you must enter a PIN to access the Remote UI.

[Set/Change PIN]

To set or change a PIN, select the check box and enter the same number both in the [PIN] and [Confirm] text boxes.

- 6 Click [OK].**

NOTE

Using the operation panel

- Remote UI Access PIN settings can also be accessed from <Menu> in the Home screen. [▶<Remote UI Settings>\(P. 243\)](#)

If <System Management Settings> are initialized

- The Remote UI Access PIN is also initialized. After an initialization, reset the PIN. [▶<Initialize Menu>\(P. 247\)](#)

LINKS

- [▶Setting Access Privileges\(P. 163\)](#)
- [▶Setting the System Manager PIN\(P. 164\)](#)

Configuring the Network Security Settings

38CS-043

Authorized users may incur unanticipated losses from attacks by malicious third parties, such as sniffing, spoofing, and tampering of data as it flows over a network. To protect your important and valuable information from these attacks, the machine supports the following features to enhance security and secrecy.

Firewall Settings

Unauthorized access by third parties, as well as network attacks and intrusions, can be blocked by limiting communication only to devices that have a specific IP address or MAC address. **Restricting Communication by Using Firewalls(P. 170)**



Changing Port Numbers

A protocol that is used to exchange information with other devices is assigned port numbers that are predetermined according to the type of protocol. The port number must be the same for all communication devices; therefore, changing it to an arbitrary number is important to prevent hacking from outside. **Changing Port Numbers(P. 176)**

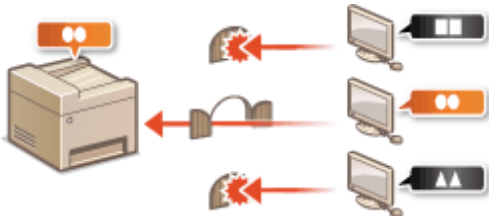

Proxy Settings

When the client devices are connected to an external network, communication is established through the proxy server. When the proxy server is used, websites can be browsed more safely, therefore, security can be expected to be enhanced. **Setting a Proxy(P. 177)**



TLS Encrypted Communication

TLS is a protocol for encryption for data sent over a network and is often used for communication via a Web browser or an e-mail application. TLS enables secure network communication when you access the machine from a computer via the Remote UI. **Configuring the Key and Certificate for TLS(P. 179)**



IEEE 802.1X Authentication

IEEE 802.1X is a standard and mechanism for blocking unauthorized access to the network by collectively managing user authentication information. If a device tries to connect to the 802.1X network, the device must go through user authentication in order to prove that the connection is made by an authorized user. Authentication information is sent to and checked by a RADIUS server, which permits or rejects communication to the network depending on the authentication result. If authentication fails, a LAN switch (or an access point) blocks access from the outside of the network. The machine can connect to an 802.1X network as a client device. **➤Configuring IEEE 802.1X Authentication Settings(P. 189)**

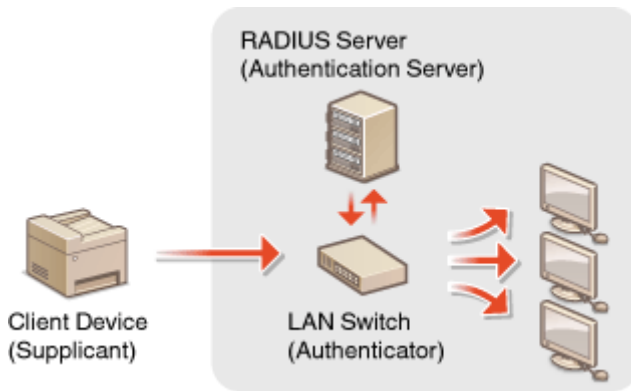

Restricting Communication by Using Firewalls

38CS-044

Without proper security, unauthorized third parties can access computers and other communication devices that are connected to a network. To prevent this unauthorized access, specify the settings for packet filter, a feature that restricts communication to devices with specified IP addresses or MAC addresses.

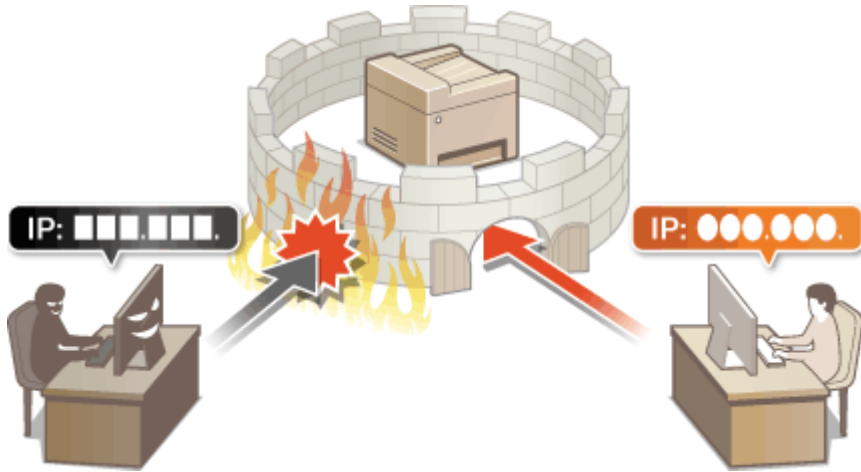

- Specifying IP Addresses for Firewall Settings(P. 171)
- Specifying MAC Addresses for Firewall Settings(P. 174)

Specifying IP Addresses for Firewall Settings

38CS-045

You can either limit communication to only devices with specified IP addresses, or block devices with specified IP addresses but permit other communications. You can specify a single IP address or a range of IP addresses.

NOTE

- For more information about the basic operations to be performed when setting the machine from the Remote UI, see [▶Setting Up Menu Options from Remote UI\(P. 205\)](#) .

1 Start the Remote UI and log in to System Manager Mode. ▶Starting Remote UI(P. 198)

2 Click [Settings/Registration] on the Portal page. ▶Remote UI Screen(P. 199)

3 Select [Security Settings] ▶ [IP Address Filter].

4 Click [Edit] to specify a filter type.

[IPv4 Address: Inbound Filter]

Restrict data received by the machine from a computer by specifying an IPv4 address.

[IPv6 Address: Inbound Filter]

Restrict data received by the machine from a computer by specifying an IPv6 address.

5 Specify the settings for packet filtering.

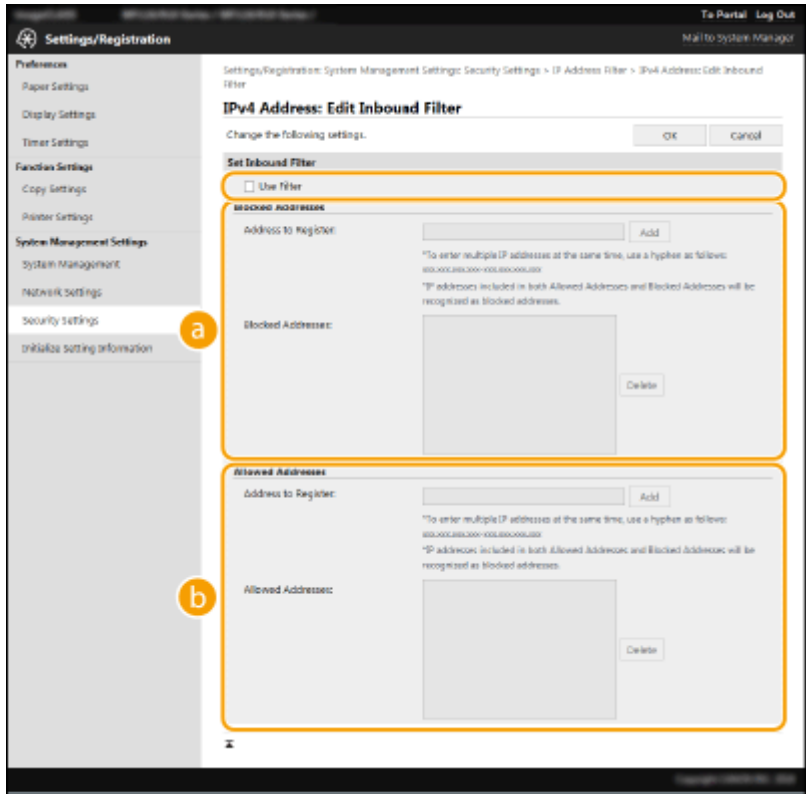

a [Blocked Addresses]

Register addresses to be blocked, as well as check or delete registered blocked addresses.

b [Allowed Addresses]

Register addresses to be allowed, as well as check or delete registered allowed addresses.

- 1** Select the [Use Filter] check box.
 - Select the check box to restrict communication. Clear the check box to disable the restriction.
- 2** Specify the address.
 - Enter the IP address (or the range of IP addresses) in the [Address to Register] text box and click [Add].

Registered address	Result
[Blocked Addresses]	Restricts communication (received) with devices having their IP addresses entered for [Address to Register]. Communication is allowed with devices with any other IP addresses.
[Allowed Addresses]	Allows communication (received) only with devices having their IP addresses entered for [Address to Register], and restricts communication with devices with any other IP addresses.
Registered as both	Allows communication (received) only with devices having their IP addresses registered in [Allowed Addresses], and restricts communication with devices with any other IP addresses. However, communication is restricted for IP addresses also registered in [Blocked Addresses].

IMPORTANT:

Check for entry errors

- If IP addresses are incorrectly entered, you may be unable to access the machine from the Remote UI, in which case you need to set <IPv4 Address Filter> or <IPv6 Address Filter> to <Off>.
- ▶<IPv4 Address Filter>(P. 242)

▶<IPv6 Address Filter>(P. 242)

NOTE:

Entry form for IP addresses

	Description	Example
Entering a single address	IPv4: Delimit numbers with periods.	192.168.0.10
	IPv6: Delimit alphanumeric characters with colons.	fe80::10
Specifying a range of addresses	Insert a hyphen between the addresses.	192.168.0.10-192.168.0.20
Specifying a range of addresses with a prefix (IPv6 only)	Enter the address, followed by a slash and a number indicating the prefix length.	fe80::1234/64

Deleting an IP address from exceptions

- Select an IP address and click [Delete].

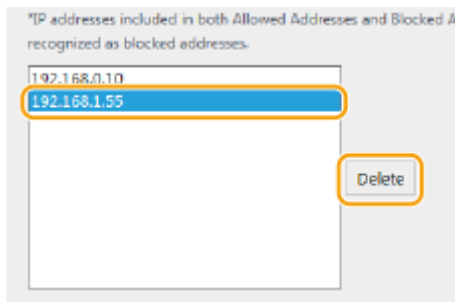

- 3 Click [OK].

NOTE

Using the operation panel

- You can also enable or disable IP address filtering from <Menu> in the Home screen.

▶<IPv4 Address Filter>(P. 242)

▶<IPv6 Address Filter>(P. 242)

LINKS

▶<Specifying MAC Addresses for Firewall Settings>(P. 174)

Specifying MAC Addresses for Firewall Settings

38CS-046

You can limit communication to only devices with specified MAC addresses.

IMPORTANT

This function is unavailable when the machine is connected to a wireless LAN.

NOTE

- For more information about the basic operations to be performed when setting the machine from the Remote UI, see [▶Setting Up Menu Options from Remote UI\(P. 205\)](#) .

- 1 Start the Remote UI and log in to System Manager Mode. [▶Starting Remote UI\(P. 198\)](#)
- 2 Click [Settings/Registration] on the Portal page. [▶Remote UI Screen\(P. 199\)](#)
- 3 Select [Security Settings] ▶ [MAC Address Filter].
- 4 Click [Edit] for the target MAC address filter.

[Inbound Filter]

Select to restrict receiving data from the machine to a computer by specifying MAC addresses.

- 5 Specify the settings for packet filtering.

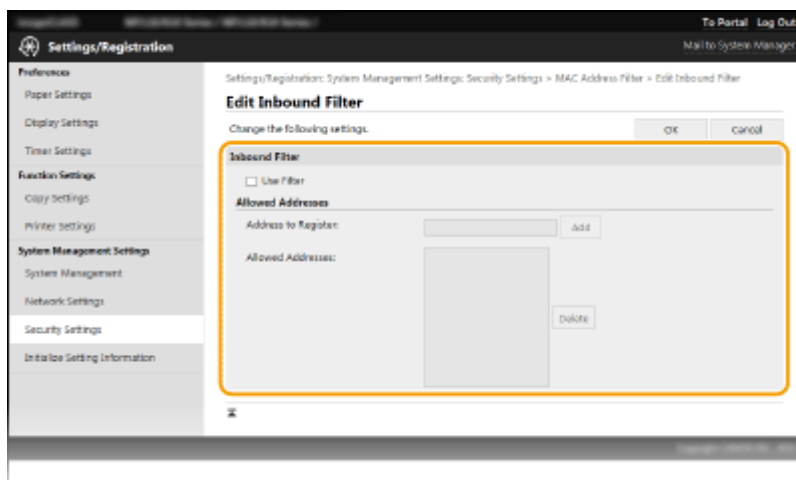

- 1 Select the [Use Filter] check box.
 - Select the check box to restrict communication. Clear the check box to disable the restriction.
- 2 Specify address exceptions.

- Enter the MAC address in the [Address to Register] text box and click [Add]. Allows communication (received) only with devices having registered MAC addresses, and restricts communication with devices with any other MAC addresses.
- You do not need to delimit the address with hyphens or colons.

IMPORTANT:

Check for entry errors

- If MAC addresses are incorrectly entered, you may become unable to access the machine from the Remote UI, in which case you need to set <MAC Address Filter> to <Off>. **▶<MAC Address Filter>(P. 243)**

NOTE:

Deleting a MAC address from exceptions

- Select a MAC address and click [Delete].

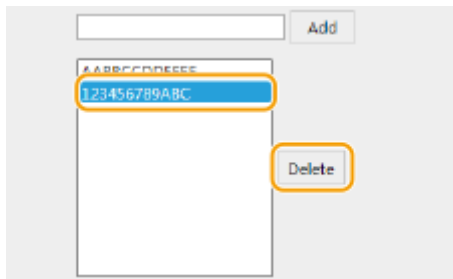

- 3 Click [OK].

NOTE

Using the operation panel

- You can also enable or disable MAC address filtering from <Menu> in the Home screen. **▶<MAC Address Filter>(P. 243)**

LINKS

- ▶ **Specifying IP Addresses for Firewall Settings(P. 171)**

Changing Port Numbers

38CS-047

Ports serve as endpoints for communicating with other devices. Typically, conventional port numbers are used for major protocols, but devices that use these port numbers are vulnerable to attacks because these port numbers are well-known. To enhance security, your Network Administrator may change the port numbers. When a port number has been changed, the new number must be shared with the communicating devices, such as computers and servers. Specify the port number settings depending on the network environment.

NOTE

- To change the port number for proxy server, see [▶Setting a Proxy\(P. 177\)](#) .

1 Select **<Menu>** in the Home screen. [▶Home Screen\(P. 78\)](#)

2 Select **<Network Settings>**.

- If the screen for entering a PIN appears, enter the correct PIN. [▶Setting the System Manager PIN\(P. 164\)](#)

3 Select **<TCP/IP Settings>** ▶ **<Port Number Settings>**.

4 Selecting the protocol of which you want to change the port number.

NOTE:

Learning more about the protocols

- **<LPD>/<RAW>/<WSD Multicast Discovery>** [▶Configuring Printing Protocols and WSD Functions\(P. 37\)](#)
- **<HTTP>** [▶Disabling HTTP Communication\(P. 195\)](#)
- **<SNMP>** [▶Monitoring and Controlling the Machine with SNMP\(P. 54\)](#)

5 Enter the port number, and select **<Apply>**.

- On how to enter text, see [▶Entering Text\(P. 83\)](#) .

LINKS

[▶Configuring Printer Ports\(P. 39\)](#)

Setting a Proxy

38CS-048

A proxy (or HTTP proxy server) refers to a computer or software that carries out HTTP communication for other devices, especially when communicating with resources outside the network, such as when browsing Web sites. The client devices connect to the outside network through the proxy server, and do not communicate directly to the resources outside. Setting a proxy not only facilitates management of traffic between in-house and outside networks but also blocks unauthorized access and consolidates anti-virus protection for enhanced security. When you use Google Cloud Print to print over the Internet, you can enhance security by setting a proxy. When setting a proxy, make sure that you have the necessary proxy information, including the IP address, port number, and a user name and password for authentication.

NOTE

- For more information about the basic operations to be performed when setting the machine from the Remote UI, see [▶Setting Up Menu Options from Remote UI\(P. 205\)](#) .

- 1 Start the Remote UI and log in to System Manager Mode. ▶Starting Remote UI(P. 198)**
- 2 Click [Settings/Registration] on the Portal page. ▶Remote UI Screen(P. 199)**
- 3 Select [Network Settings] ▶ [TCP/IP Settings].**
- 4 Click [Edit] in [Proxy Settings].**
- 5 Select the [Use Proxy] check box and specify the required settings.**

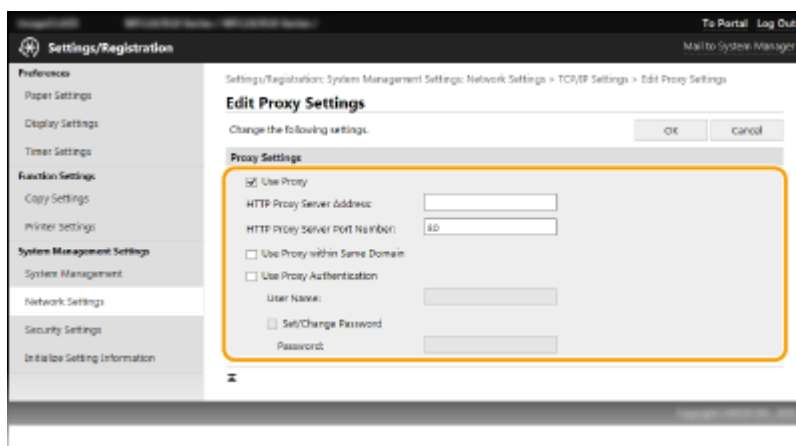

[Use Proxy]

Select the check box to use the specified proxy server when communicating with an HTTP server.

[HTTP Proxy Server Address]

Enter the address of the proxy server. Specify the IP address or host name depending on the environment.

[HTTP Proxy Server Port Number]

Change the port number as necessary.

[Use Proxy within Same Domain]

Select the check box to also use the specified proxy server for communication with devices in the same domain.

[Use Proxy Authentication]

To enable authentication by the proxy server, select the check box and enter alphanumeric characters for the user name in the [User Name] text box.

[Set/Change Password]

To set or change the password for the proxy authentication, when it is enabled, select the check box and enter alphanumeric characters for the new password in the [Password] text box.

6 Click [OK].

LINKS

▶ Using Google Cloud Print(P. 157)

Configuring the Key and Certificate for TLS

38CS-049

You can encrypt communication between the machine and a Web browser on the computer by using Transport Layer Security (TLS). TLS is a mechanism for encrypting data sent or received over the network. TLS must be enabled when the Remote UI is used for specifying settings such as SNMPv3. To use TLS encrypted communication for the Remote UI, you need to specify a "key and certificate" (server certificate) you want to use before enabling TLS. Generate or install the key and certificate for TLS before enabling TLS ([▶Management Functions\(P. 329\)](#)).



NOTE

- For more information about the basic operations to be performed when setting the machine from the Remote UI, see [▶Setting Up Menu Options from Remote UI\(P. 205\)](#) .

- 1 Start the Remote UI and log in to System Manager Mode. [▶Starting Remote UI\(P. 198\)](#)**
- 2 Click [Settings/Registration] on the Portal page. [▶Remote UI Screen\(P. 199\)](#)**
- 3 Select [Network Settings] ▶ [TCP/IP Settings].**
- 4 Click [Key and Certificate] in [TLS Settings].**
- 5 Click [Register Default Key] on the right of the key and certificate you want to use.**

NOTE:

Viewing details of a certificate

- You can check the details of the certificate or verify the certificate by clicking the corresponding text link under [Key Name], or the certificate icon.

6 Enable TLS for the Remote UI.

- 1 Click [Security Settings] ▶ [Remote UI Settings].**
- 2 Click [Edit].**
- 3 Select the [Use TLS] check box and click [OK].**

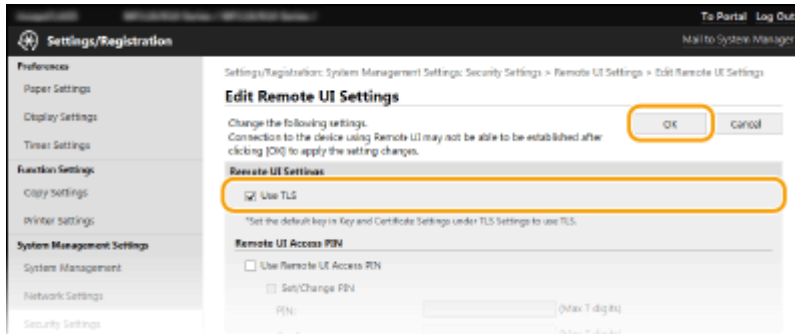

NOTE

Using the operation panel

- You can also enable or disable TLS encrypted communication from <Menu> in the Home screen. ▶<Use TLS>(P. 242)

Starting the Remote UI with TLS

- If you try to start the Remote UI when TLS is enabled, a security alert may be displayed regarding the security certificate. In this case, check that the correct URL is entered in the address field, and then proceed to display the Remote UI screen. ▶Starting Remote UI(P. 198)

LINKS

- ▶Monitoring and Controlling the Machine with SNMP(P. 54)
- ▶Generating the Key and Certificate for Network Communication(P. 181)
- ▶Generating a Key and Certificate Signing Request (CSR)(P. 184)
- ▶Registering the Key and Certificate for Network Communication(P. 187)
- ▶Configuring IEEE 802.1X Authentication Settings(P. 189)

Generating the Key and Certificate for Network Communication

38CS-04A

A key and certificate can be generated with the machine when it is required for encrypted communication via Transport Layer Security (TLS). You can use TLS when accessing the machine via the Remote UI. Self-signed certificates are used with the key and certificate generated in "Network Communication."

NOTE

- If you want to use a server certificate that has a CA signature, you can generate a CSR together with a key instead of a certificate. ▶ **Generating a Key and Certificate Signing Request (CSR)(P. 184)**
- For more information about the basic operations to be performed when setting the machine from the Remote UI, see ▶ **Setting Up Menu Options from Remote UI(P. 205)** .

- 1 Start the Remote UI and log in to System Manager Mode. ▶ Starting Remote UI(P. 198)**
- 2 Click [Settings/Registration] on the Portal page. ▶ Remote UI Screen(P. 199)**
- 3 Select [Security Settings] ▶ [Key and Certificate Settings].**
- 4 Click [Generate Key].**

NOTE:

Deleting a registered key and certificate

- Click [Delete] on the right of the key and certificate you want to delete ▶ click [OK].
- A key and certificate cannot be deleted if it is currently used for some purpose, such as when "[TLS]" is displayed under [Key Usage]. In this case, disable the function or replace the other key and certificate before deleting it.

- 5 Select [Network Communication] and click [OK].**
- 6 Specify settings for the key and certificate.**

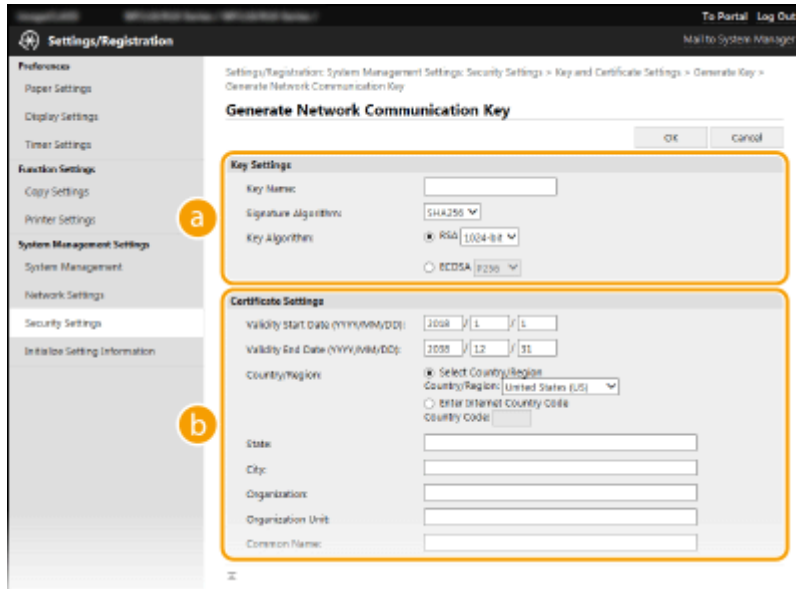

a [Key Settings]

[Key Name]

Enter alphanumeric characters for naming the key. Set a name that will be easy for you to find later in a list.

[Signature Algorithm]

Select the signature algorithm from the drop-down list.

[Key Algorithm]

Select the key generation algorithm from [RSA] or [ECDSA], then select the key length from the drop-down list. In either case, the larger the number for the key length is, the higher the security level becomes. However, the communication speed becomes slower.

NOTE:

- When [SHA384] or [SHA512] is selected in [Signature Algorithm], [512-bit] cannot be selected as the key length when [RSA] is selected in [Key Algorithm].

b [Certificate Settings]

[Validity Start Date (YYYY/MM/DD)]

Enter the validity start date of the certificate, in the order of: year, month, day.

[Validity End Date (YYYY/MM/DD)]

Enter the validity end date of the certificate, in the order of: year, month, day. A date earlier than [Validity Start Date (YYYY/MM/DD)] cannot be set.

[Country/Region]

Click the [Select Country/Region] radio button and select the country/region from the drop-down list. You can also click the [Enter Internet Country Code] radio button and enter a country code, such as "US" for the United States.

[State]/[City]

Enter alphanumeric characters for the location as necessary.

[Organization]/[Organization Unit]

Enter alphanumeric characters for the organization name as necessary.

[Common Name]

Enter alphanumeric characters for the common name of the certificate as necessary. "Common Name" is often abbreviated as "CN."

7 Click [OK].

- Generating a key and certificate may take some time.
- After the key and certificate is generated, it is automatically registered to the machine.

LINKS

▶ **Configuring the Key and Certificate for TLS(P. 179)**

▶ **Registering the Key and Certificate for Network Communication(P. 187)**

Generating a Key and Certificate Signing Request (CSR)

38CS-04C

Because certificates generated on the machine do not have a CA signature, a communication error may result depending on devices it communicates with. To have the certificate authority issue the certificate with the CA signature, you need to obtain data of CSR (Certificate Signing Request), which the administrator can generate from Remote UI. When the certificate is issued, register it in the key with the CSR generated.

▶ **Generating a Key and CSR(P. 184)**

▶ **Registering a Certificate to a Key(P. 186)**

NOTE

- For more information about the basic operations to be performed when setting the machine from the Remote UI, see ▶ **Setting Up Menu Options from Remote UI(P. 205)** .

Generating a Key and CSR

- 1 Start the Remote UI and log in to System Manager Mode. ▶ Starting Remote UI(P. 198)**
- 2 Click [Settings/Registration] on the Portal page. ▶ Remote UI Screen(P. 199)**
- 3 Select [Security Settings] ▶ [Key and Certificate Settings].**
- 4 Click [Generate Key].**

NOTE:

Deleting a registered key and certificate

- Click [Delete] on the right of the key and certificate you want to delete ▶ click [OK].
- A key and certificate cannot be deleted if it is currently used for some purpose, such as when "[TLS]" is displayed under [Key Usage]. In this case, disable the function or replace the key and certificate before deleting it.

- 5 Select [Key and Certificate Signing Request (CSR)] and click [OK].**
- 6 Specify settings for the key and CSR.**

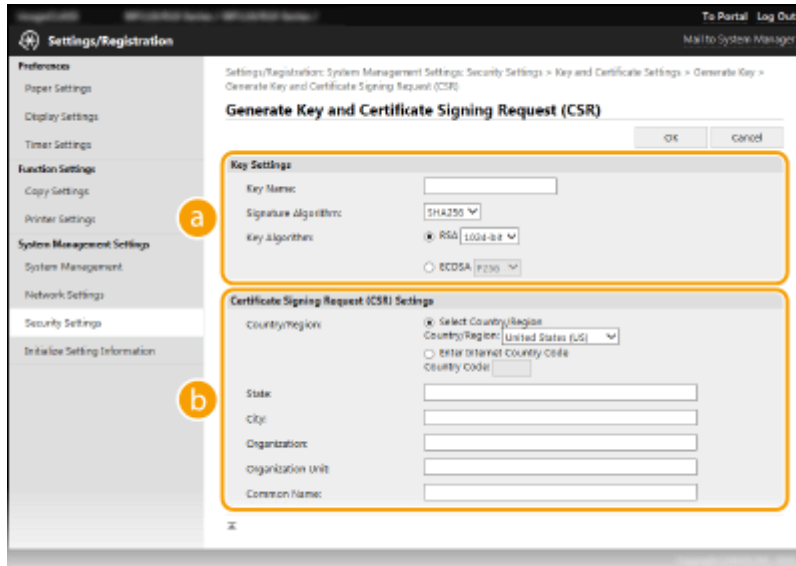

a [Key Settings]

[Key Name]

Enter alphanumeric characters for naming the key. Set a name that will be easy for you to find later in a list.

[Signature Algorithm]

Select the signature algorithm from the drop-down list.

[Key Algorithm]

Select the key generation algorithm from [RSA] or [ECDSA], then select the key length from the drop-down list. In any case, the larger the number for the key length, the slower the communication. However, the security is tighter.

NOTE:

- When [SHA384] or [SHA512] is selected in [Signature Algorithm], [512-bit] cannot be selected as the key length when [RSA] is selected in [Key Algorithm].

b [Certificate Signing Request (CSR) Settings]

[Country/Region]

Click the [Select Country/Region] radio button and select the country/region from the drop-down list. You can also click the [Enter Internet Country Code] radio button and enter a country code, such as "US" for the United States.

[State]/[City]

Enter alphanumeric characters for the location as necessary.

[Organization]/[Organization Unit]

Enter alphanumeric characters for the organization name as necessary.

[Common Name]

Enter alphanumeric characters for the common name of the certificate as necessary. "Common Name" is often abbreviated as "CN."

7 Click [OK].

- Generating a key and CSR may take some time.

8 Click [Store in File].

- A dialog box for storing the file appears. Choose where to store the file and click [Save].

⇒ The CSR file is stored on the computer.

9 Attach the stored file and submit the application to the certification authority.

Registering a Certificate to a Key

The key with the CSR generated cannot be used until the certificate issued from the certificate authority based on the CSR is registered in the key. Once the certification authority has issued the certificate, register it using the procedure below.

- 1 Start the Remote UI and log in to System Manager Mode. ▶ Starting Remote UI(P. 198)
- 2 Click [Settings/Registration] on the Portal page. ▶ Remote UI Screen(P. 199)
- 3 Select [Security Settings] ▶ [Key and Certificate Settings].
- 4 Click [Key Name] or [Certificate] required to register the certificate.

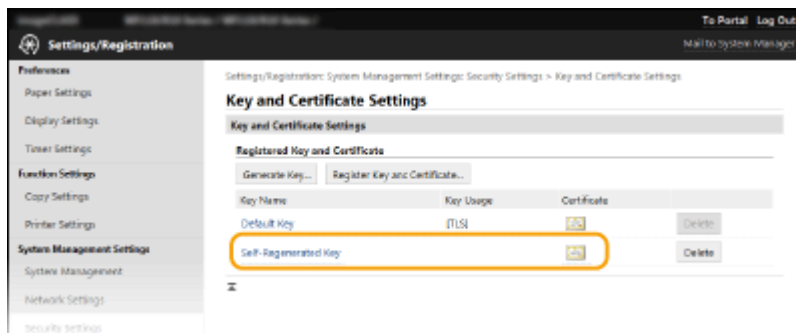

- 5 Click [Register Certificate].
- 6 Click [Browse], specify the file for the certificate signing request, and click [Register].

LINKS

- ▶ Configuring the Key and Certificate for TLS(P. 179)
- ▶ Generating the Key and Certificate for Network Communication(P. 181)
- ▶ Registering the Key and Certificate for Network Communication(P. 187)

Registering the Key and Certificate for Network Communication

38CS-04E

You can obtain the key and certificate, and the CA certificate from a certification authority (CA) for use with the machine. Install and register the obtained key and certificate file and CA certificate file in this machine using Remote UI. Check the key and certificate, and CA certificate conditions that are required for the machine in advance (▶ **Management Functions(P. 329)**).



NOTE

- For more information about the basic operations to be performed when setting the machine from the Remote UI, see ▶ **Setting Up Menu Options from Remote UI(P. 205)** .

- 1 Start the Remote UI and log in to System Manager Mode. ▶Starting Remote UI(P. 198)**
- 2 Click [Settings/Registration] on the Portal page. ▶Remote UI Screen(P. 199)**
- 3 Select [Security Settings] ▶ [Key and Certificate Settings] or [CA Certificate Settings].**
 - Click [Key and Certificate Settings] to install a key and certificate, or [CA Certificate Settings] to install a CA certificate.
- 4 Click [Register Key and Certificate] or [Register CA Certificate].**

NOTE:

Deleting a registered key and certificate or CA certificate

- Click [Delete] on the right of the key and certificate or CA certificate you want to delete ▶ click [OK]. You cannot delete the preinstalled CA certificates.
- A key and certificate cannot be deleted if it is currently used for some purpose, such as when "[TLS]" is displayed under [Key Usage]. In this case, disable the function or replace the key and certificate before deleting it.

Disabling or enabling the preinstalled CA certificates

- Click [Disable] on the right of the preinstalled CA certificate you want to disable. To enable the certificate again, click [Enable] on the right of the certificate.

- 5 Click [Install].**

NOTE:

Deleting the key and certificate file or CA certificate file

- Click [Delete] on the right of the file you want to delete ► click [OK].

6 Click [Browse], specify the file to install, and click [Start Installation].

► The key and certificate file or the CA certificate file is installed on the machine from a computer.

7 Register the key and certificate or CA certificate.

■ Registering a key and certificate

- 1 Click [Register] on the right of the key and certificate file you want to register.
- 2 Enter the name of the key and password.

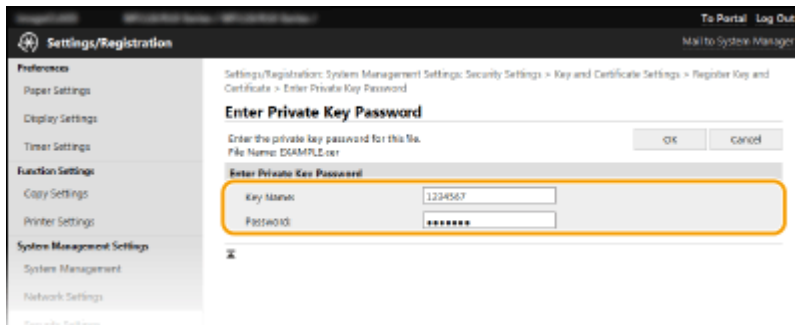

[Key Name]

Enter alphanumeric characters for the name of the key to be registered.

[Password]

Enter alphanumeric characters for the password of the private key set for the file to be registered.

- 3 Click [OK].

■ Registering a CA certificate

Click [Register] on the right of the CA certificate file you want to register.

LINKS

- **Configuring the Key and Certificate for TLS(P. 179)**
- **Generating the Key and Certificate for Network Communication(P. 181)**
- **Configuring IEEE 802.1X Authentication Settings(P. 189)**

Configuring IEEE 802.1X Authentication Settings

38CS-04F

The machine can connect to an 802.1X network as a client device. A typical 802.1X network consists of a RADIUS server (authentication server), LAN switch (authenticator), and client devices with authentication software (supplicants). If a device tries to connect to the 802.1X network, the device must go through user authentication in order to prove that the connection is made by an authorized user. Authentication information is sent to and checked by a RADIUS server, which permits or rejects communication to the network depending on the authentication result. If authentication fails, a LAN switch (or an access point) blocks access from the outside of the network.

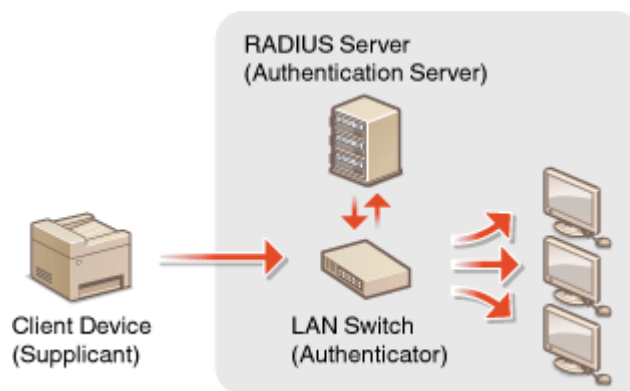

IEEE 802.1X Authentication Method

Select the authentication method from the options below. If necessary, install or register a key and certificate or a CA certificate before configuring IEEE 802.1X authentication ([▶Registering the Key and Certificate for Network Communication\(P. 187\)](#)).

■ TLS

The machine and the authentication server authenticate each other by mutually verifying their certificates. A key and certificate issued by a certification authority (CA) is required for the client authentication (when authenticating the machine). For the server authentication, a CA certificate installed via the Remote UI can be used in addition to a CA certificate preinstalled in the machine.

■ TTLS

This authentication method uses a user name and password for the client authentication and a CA certificate for the server authentication. MSCHAPv2 or PAP can be selected as the internal protocol. TTLS can be used with PEAP at the same time. Enable TLS for the Remote UI before configuring this authentication method ([▶Configuring the Key and Certificate for TLS\(P. 179\)](#)).

■ PEAP

The required settings are almost the same as those of TTLS. MSCHAPv2 is used as the internal protocol. Enable TLS for the Remote UI before configuring this authentication method ([▶Configuring the Key and Certificate for TLS\(P. 179\)](#)).

NOTE

- For more information about the basic operations to be performed when setting the machine from the Remote UI, see [▶Setting Up Menu Options from Remote UI\(P. 205\)](#) .

- 1 Start the Remote UI and log in to System Manager Mode. [▶Starting Remote UI\(P. 198\)](#)

2 Click [Settings/Registration] on the Portal page. ▶ Remote UI Screen(P. 199)

3 Select [Network Settings] ▶ [IEEE 802.1X Settings].

4 Click [Edit].

5 Select the [Use IEEE 802.1X] check box, and enter the login name in the [Login Name] text box.

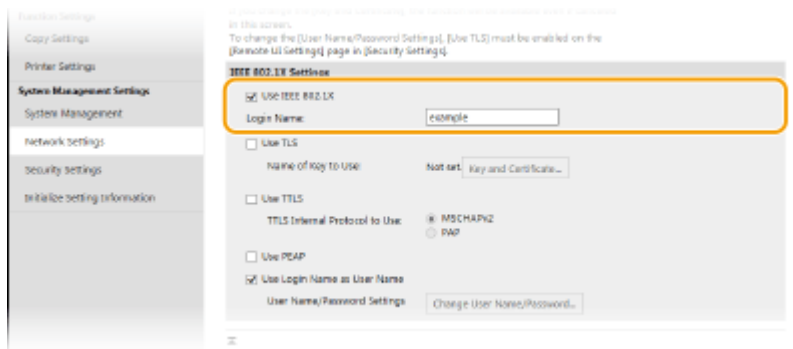

[Use IEEE 802.1X]

Select the check box to enable IEEE 802.1X authentication.

[Login Name]

Enter alphanumeric characters for a name (EAP identity) that is used for identifying the user.

6 Configure the required settings according to the specified authentication method.

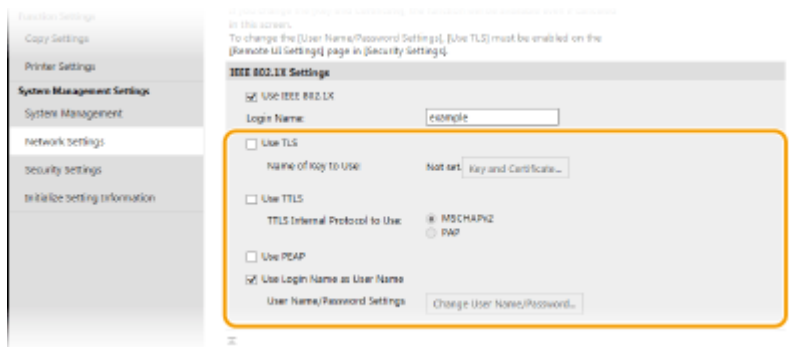

■ Setting TLS

1 Select the [Use TLS] check box and click [Key and Certificate].

2 Click [Register Default Key] on the right of the key and certificate you want to use for the client authentication.

NOTE:

Viewing details of a certificate

- You can check the details of the certificate or verify the certificate by clicking the corresponding text link under [Key Name], or the certificate icon.

■ Setting TTLS/PEAP

- 1 Select the [Use TTLS] or [Use PEAP] check box.

NOTE:

Internal protocol for TTLS

- You can select [MSCHAPv2] or [PAP].

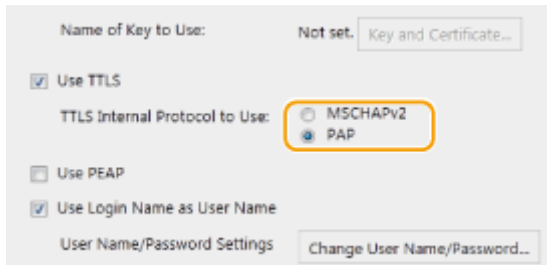

- 2 Click [Change User Name/Password].

- To specify a user name other than the login name, clear the [Use Login Name as User Name] check box. Select the check box if you want to use the login name as the user name.

- 3 Set the user name/password.

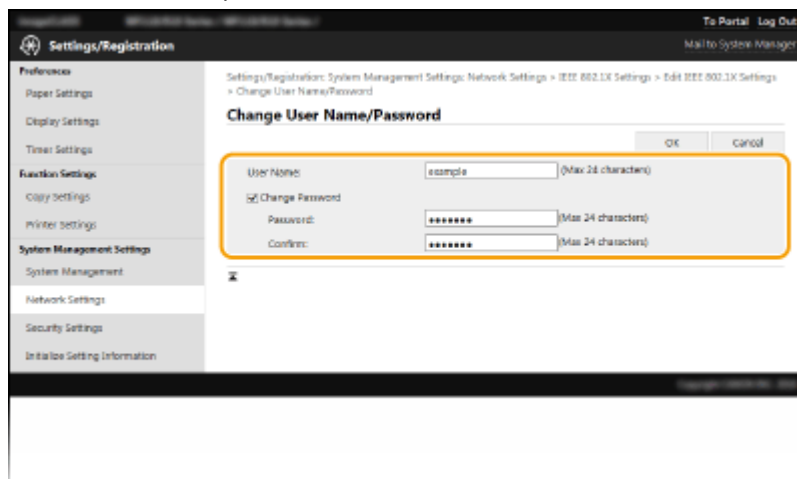

[User Name]

Enter alphanumeric characters for the user name.

[Change Password]

To set or change the password, select the check box and enter alphanumeric characters for the new password both in the [Password] and [Confirm] text boxes.

- 4 Click [OK].

- 7 Click [OK].

- 8 Restart the machine.

- Turn OFF the machine, wait for at least 10 seconds, and turn it back ON.

NOTE

Using the operation panel

- You can also enable or disable IEEE 802.1X authentication from <Menu> in the Home screen. [▶<IEEE 802.1X Settings>\(P. 222\)](#)

LINKS

- [▶Configuring the Key and Certificate for TLS\(P. 179\)](#)

Restricting the Machine's Functions

38CS-04H

Some of the functions of the machine may rarely be used or provide opportunities for misuse. For security purposes, the machine can be set to limit its capabilities by partially or completely disabling these functions.

Restricting USB Functions

The USB connection allows an easy connection with peripheral devices, but it may cause a security risk such as an information leakage. You can restrict a USB connection with a computer. [▶Restricting USB Functions\(P. 194\)](#)



Disabling HTTP Communication

When not performing operations via the network, for example, when using the machine via USB connection, you can disable HTTP communication to prevent a hacking via the HTTP port. [▶Disabling HTTP Communication\(P. 195\)](#)



Disabling Remote Management

When not using Remote UI, you can disable functions to prevent an unauthorized remote operation via Remote UI. [▶Disabling Remote UI\(P. 196\)](#)



Restricting USB Functions

38CS-04J

USB is a convenient way of connecting peripheral devices and storing or relocating data, but USB can also be a source of information leakage if it is not properly managed. This section describes how to restrict connection via the USB port of the machine.



Restricting the USB Connection with a Computer(P. 194)

Restricting the USB Connection with a Computer

You can disable the USB port that is used for connecting the machine to a computer. If this port is disabled, the machine cannot communicate with a computer via USB.



<Menu> ▶ <System Management Settings> ▶ <Use as USB Device> ▶ <Off> ▶ Restart the machine

Disabling HTTP Communication

38CS-04K

HTTP is used for communications over the network, such as when you access the machine via the Remote UI. If you are using a USB connection or are otherwise not using HTTP, you can disable HTTP to block malicious third-party intrusions via the unused HTTP port.



IMPORTANT

- Disabling HTTP disables some of the network capabilities, such as the Remote UI, WSD printing, and printing with Google Cloud Print.



<Menu> ▶ <Network Settings> ▶ <TCP/IP Settings> ▶ <Use HTTP> ▶ <Off> ▶ <Yes>

LINKS

- ◉ [Configuring Printing Protocols and WSD Functions\(P. 37\)](#)
- ◉ [Using Google Cloud Print\(P. 157\)](#)
- ◉ [Changing Port Numbers\(P. 176\)](#)
- ◉ [Managing the Machine from a Computer \(Remote UI\)\(P. 197\)](#)

Disabling Remote UI

38CS-04L

The Remote UI is useful because the machine settings can be specified by using a Web browser on a computer. To use the Remote UI, the machine must be connected to a computer over the network. If the machine is connected to a computer via USB, or if you do not need to use the Remote UI, you might want to disable the Remote UI to reduce the risk of having your machine controlled remotely over the network by malicious third parties.



<Menu> ▶ <System Management Settings> ▶ <Remote UI Settings> ▶ <Use Remote UI> ▶ <Off>

LINKS

- ▶ **Disabling HTTP Communication(P. 195)**
- ▶ **Managing the Machine from a Computer (Remote UI)(P. 197)**

Managing the Machine from a Computer (Remote UI)

38CS-04R

Using a Web browser to operate the machine remotely, you can check the documents waiting to be printed or the status of the machine. You can also make various settings. You can do this without leaving your desk, making system management easier. For more information about the system requirements for the Remote UI, see **System Environment(P. 330)** .

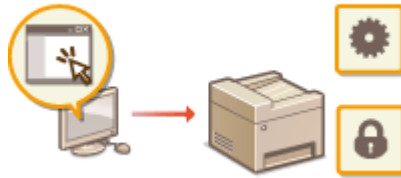

Functions of the Remote UI

- ▶ **Checking the Status and Logs(P. 201)**
- ▶ **Setting Up Menu Options from Remote UI(P. 205)**

Basics of the Remote UI

- ▶ **Starting Remote UI(P. 198)**

Starting Remote UI

38CS-04S

To operate remotely, you need to input the IP address of the machine into a Web browser and start the Remote UI. Check the IP address set to the machine in advance ([▶Viewing Network Settings\(P. 34\)](#)). If you have any questions, ask your Network Administrator.

1 Start the Web browser.

2 Enter "http://<the IP address of the machine>/" in the address field, and press the [ENTER] key.

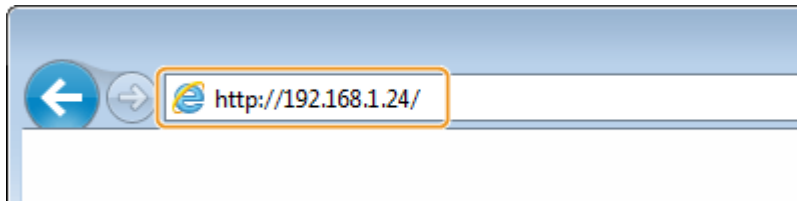

- If you want to use an IPv6 address, enclose the IPv6 address with brackets (example: http://[fe80::2e9e:fcff:fe4e:dbce]/).

NOTE:

If a security alert is displayed

- A security alert may be displayed when the Remote UI communication is encrypted ([▶Configuring the Key and Certificate for TLS\(P. 179\)](#)). When certificate settings or TLS settings have no errors, continue browsing the Web site.

3 Log in to the Remote UI.

■When a System Manager PIN is not set

Select [System Manager Mode] or [General User Mode].

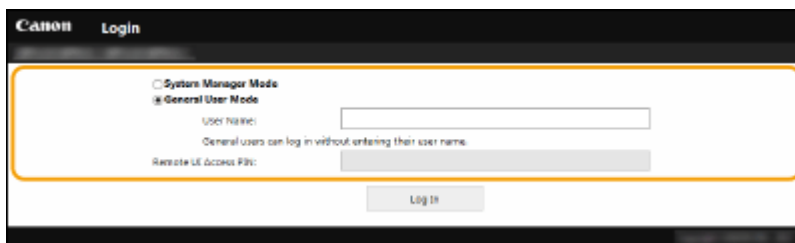

[System Manager Mode]

You can perform all the Remote UI operations and settings.

[General User Mode]

You can check the status of documents or the machine, and you can also change some of the settings. When you want to check if a specific document of yours is in the print queue or cancel the printing of a document of yours in the print queue, enter the user name of the document in [User Name]. The user name is automatically set to print documents based on information such as your computer name or computer login name.

[Remote UI Access PIN]

If [Remote UI Access PIN] is set, enter the PIN. [▶Setting a Remote UI PIN\(P. 166\)](#)

■ When a System Manager PIN is set

Enter the appropriate PIN in [System Manager PIN] to log in to System Manager Mode. ▶ **Setting the System Manager PIN(P. 164)**

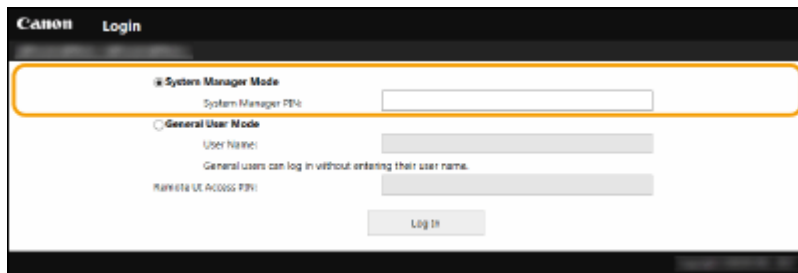

4 Click [Log In].

⇒ The Portal page (main page) will be displayed. ▶ **Remote UI Screen(P. 199)**

Remote UI Screen

When you log in to the Remote UI, the following Portal page appears. This section describes the items displayed on the Portal page and the basic operations.

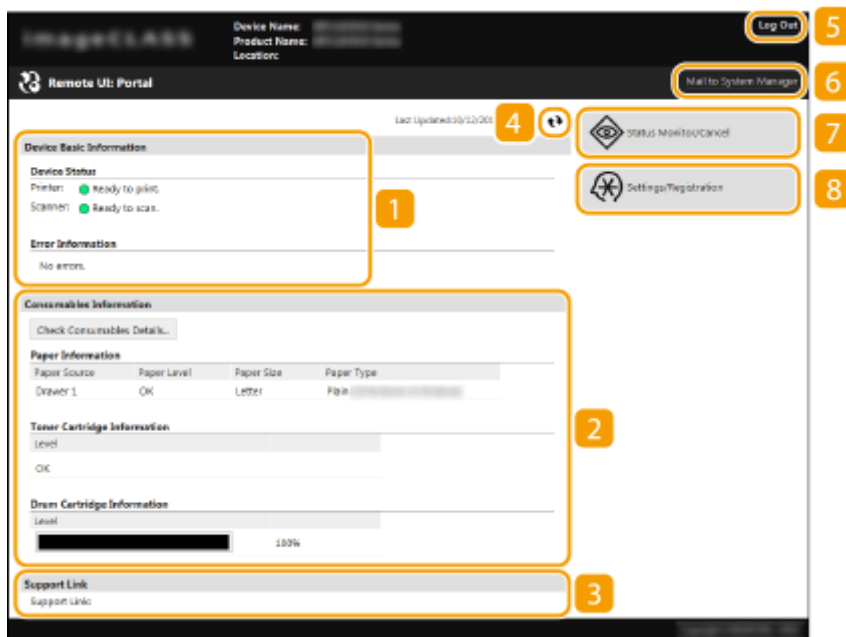

1 [Device Basic Information]

Displays the current status of the machine and error information. If an error has occurred, the link to the Error Information page will be displayed.

2 [Consumables Information]

Displays information about consumables.

3 [Support Link]

Displays the support link specified in [Device Information] under [System Management].

4 Refresh Icon

Refreshes the currently displayed page.

5 [Log Out]

Logs off from the Remote UI. The Login page will be displayed.

6 [Mail to System Manager]

Displays a window for creating an e-mail to the system manager specified in [System Manager Information] under [System Management].

7 [Status Monitor/Cancel]

Displays the [Status Monitor/Cancel] page. For any of the waiting documents, you can check the status/history or cancel the processing.

8 [Settings/Registration]

Displays [Settings/Registration] page. When you have logged in to System Manager Mode, you can change the settings items and save/load the registered data. ▶ **Setting Up Menu Options from Remote UI(P. 205)**

Checking the Status and Logs

38CS-04U

- ▶ Checking Current Status of Print Documents(P. 201)
- ▶ Checking History of Documents(P. 202)
- ▶ Checking Error Information(P. 202)
- ▶ Checking Consumables(P. 202)
- ▶ Checking Device Specifications(P. 203)
- ▶ Checking System Manager Information(P. 203)
- ▶ Checking Print Total Counter(P. 204)
- ▶ Checking Eco Information(P. 204)

NOTE

- A file name of a document may not be displayed in full. The printed application name may be added to the file name.

Checking Current Status of Print Documents

The list of the documents currently printing or waiting to be printed is displayed.



Log in to the Remote UI (▶ **Starting Remote UI(P. 198)**) ▶ [Status Monitor/Cancel] ▶ [Job Status]

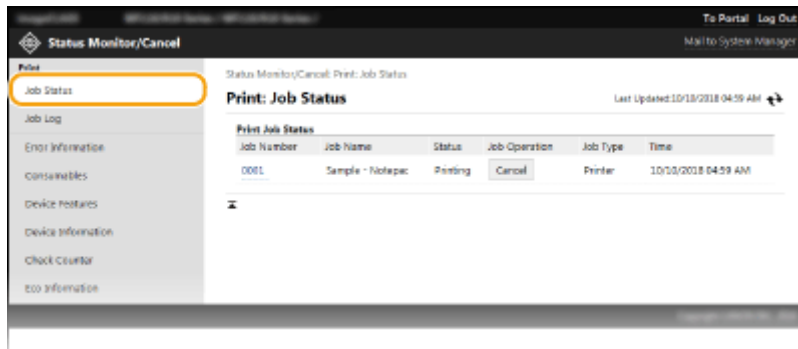

- You can delete a document job by clicking [Cancel].

NOTE

- If you logged on in System Manager Mode, all the print documents currently printing and waiting to be printed will be listed.
- If you entered your user name when you logged on in General User Mode, your user name will only be displayed on the documents that you printed.
- Click [Job Number] on the paused documents to display detailed information. You can check the user name and the page count of the printed document.

Checking History of Documents

The history of print is displayed.



Log in to the Remote UI ([▶ Starting Remote UI\(P. 198\)](#)) ▶ [Status Monitor/Cancel] ▶ [Job Log]

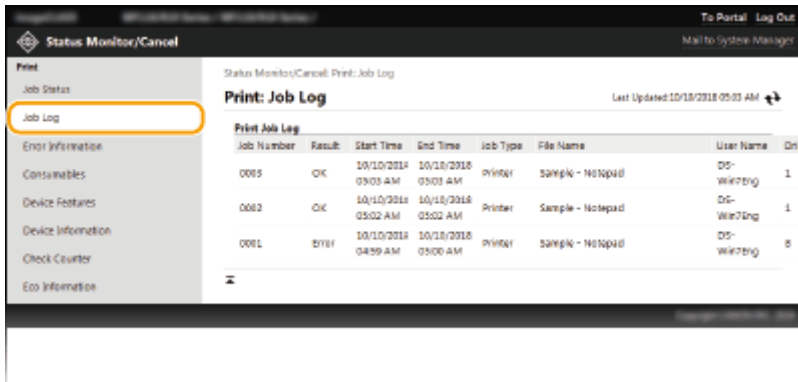

Checking Error Information

When an error occurs, this page will be displayed by clicking the message displayed under [Error Information] on the Portal page (main page). [▶ Remote UI Screen\(P. 199\)](#)



Log in to the Remote UI ([▶ Starting Remote UI\(P. 198\)](#)) ▶ [Status Monitor/Cancel] ▶ [Error Information]

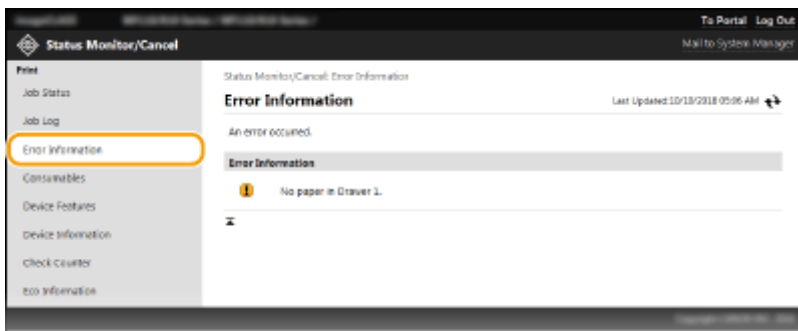

Checking Consumables

Paper size and paper type for the paper source, toner cartridge model number, etc. are displayed. You can also click [Check Consumables Details] in the Portal page (main page) to display this page ([▶ Remote UI Screen\(P. 199\)](#)).



Log in to the Remote UI ([▶ Starting Remote UI\(P. 198\)](#)) ▶ [Status Monitor/Cancel] ▶ [Consumables]

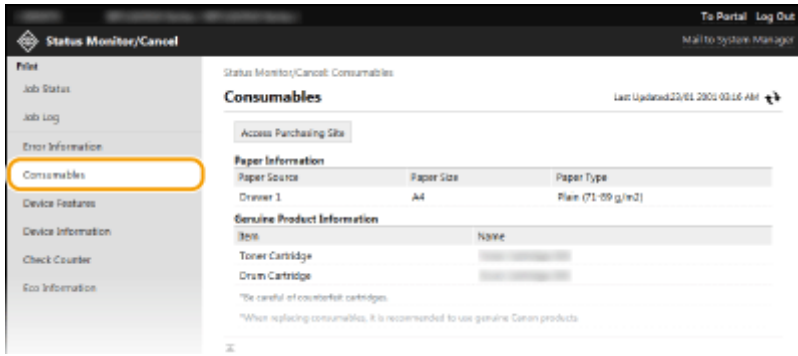

Checking Device Specifications

The maximum print speed is displayed.



Log in to the Remote UI (▶ **Starting Remote UI(P. 198)**) ▶ [Status Monitor/Cancel] ▶ [Device Features]

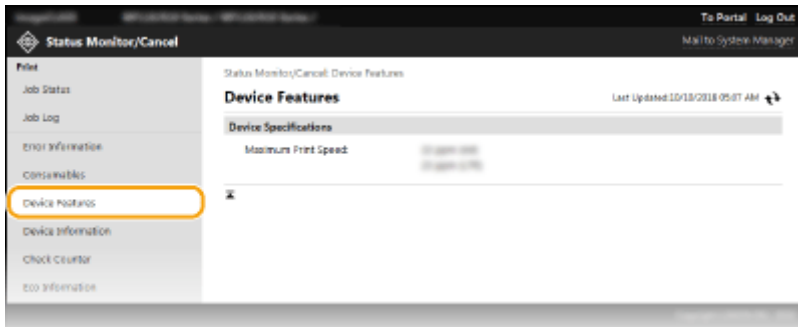

Checking System Manager Information

Information about the machine and the system manager is displayed. This information is set in [System Management] on the [Settings/Registration] page.



Log in to the Remote UI (▶ **Starting Remote UI(P. 198)**) ▶ [Status Monitor/Cancel] ▶ [Device Information]

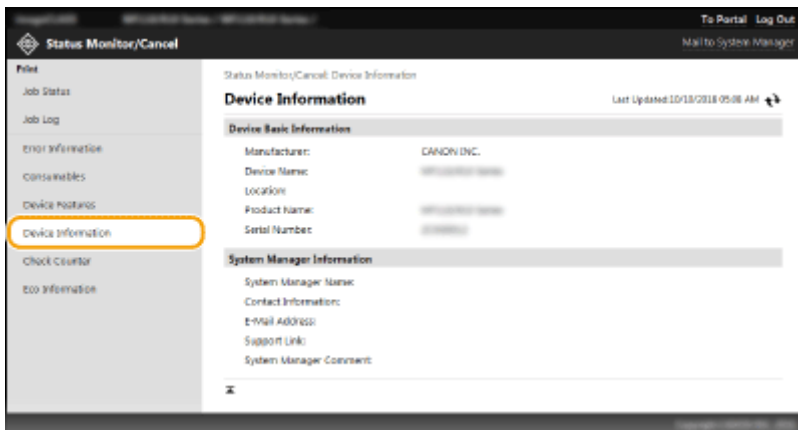

Checking Print Total Counter

The total number of pages that have been printed by the copy and print functions is displayed.



Log in to the Remote UI (▶ **Starting Remote UI(P. 198)**) ▶ [Status Monitor/Cancel] ▶ [Check Counter]

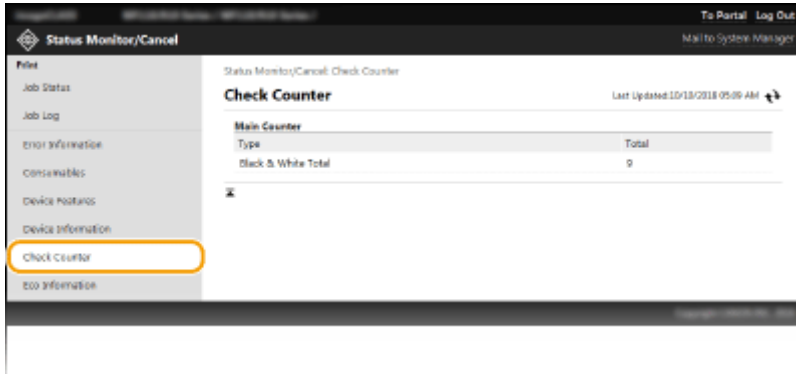

Checking Eco Information

You can check information such as the number of printouts per month and amount of consumed power. Also, you can check and change the copy settings of the device to save paper and energy.



Log in to the Remote UI (▶ **Starting Remote UI(P. 198)**) ▶ [Status Monitor/Cancel] ▶ [Eco Information]

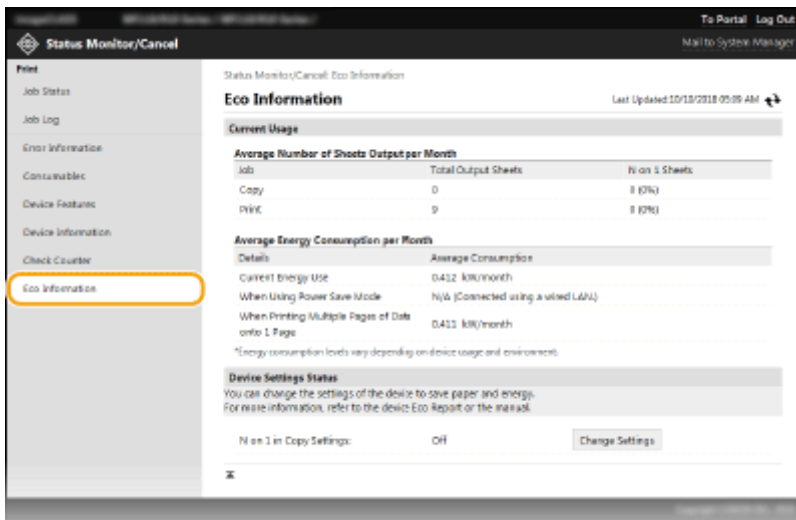

LINKS

▶ **Remote UI Screen(P. 199)**

Setting Up Menu Options from Remote UI

38CS-04W

You can change the various machine settings by using the Remote UI. Most of the settings can be set also on the machine, but some settings can only be set using the Remote UI. This section describes the basic flow of changing the settings of the machine using the Remote UI.

NOTE

- Some settings can only be changed when you have logged in to System Manager Mode.
- Some settings may require operations that differ from the procedure described here.

- 1 Start the Remote UI. ▶Starting Remote UI(P. 198)**
- 2 Click [Settings/Registration] on the Portal page. ▶Remote UI Screen(P. 199)**
- 3 Click the setting you want to configure in the menu on the left side of the screen.**

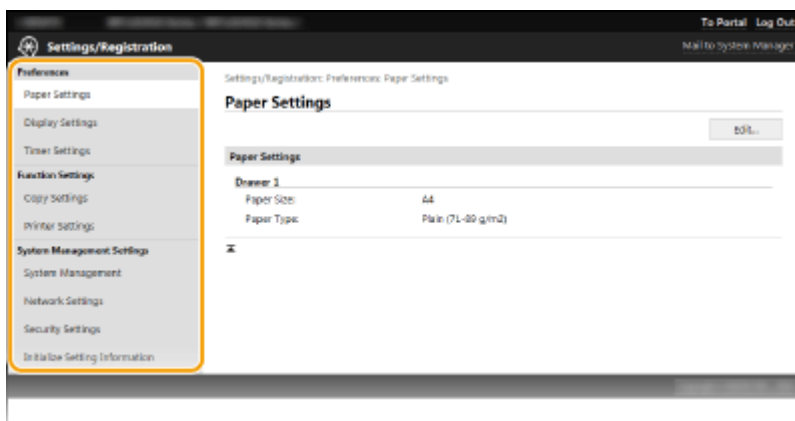

- 4 Click the link to display the desired page as necessary.**

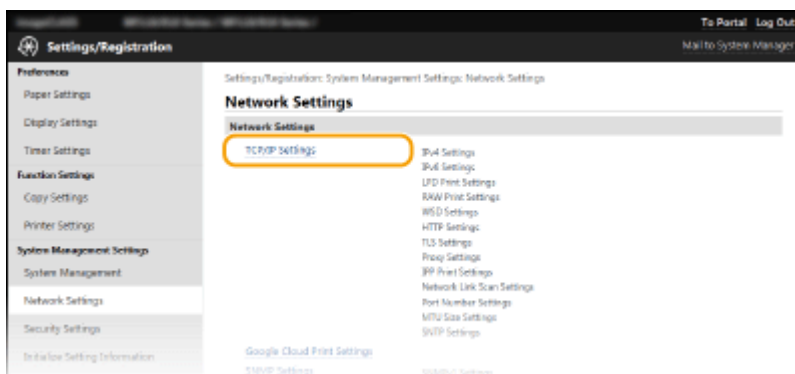

- 5 Click [Edit].**

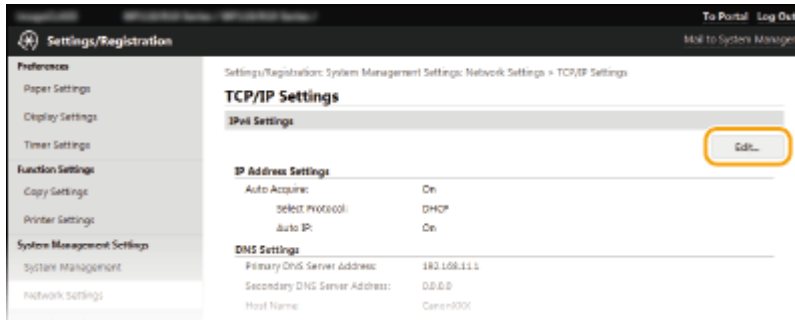

6 Specify the required settings.

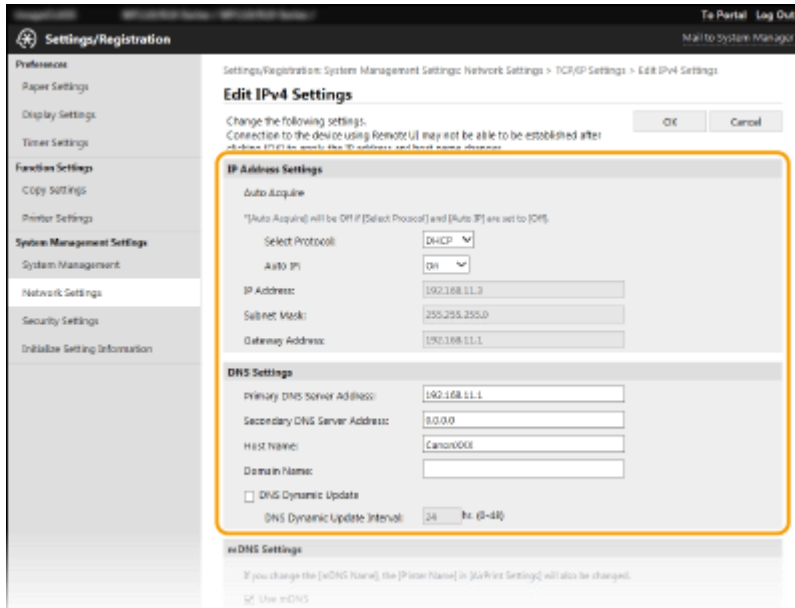

7 Click [OK].

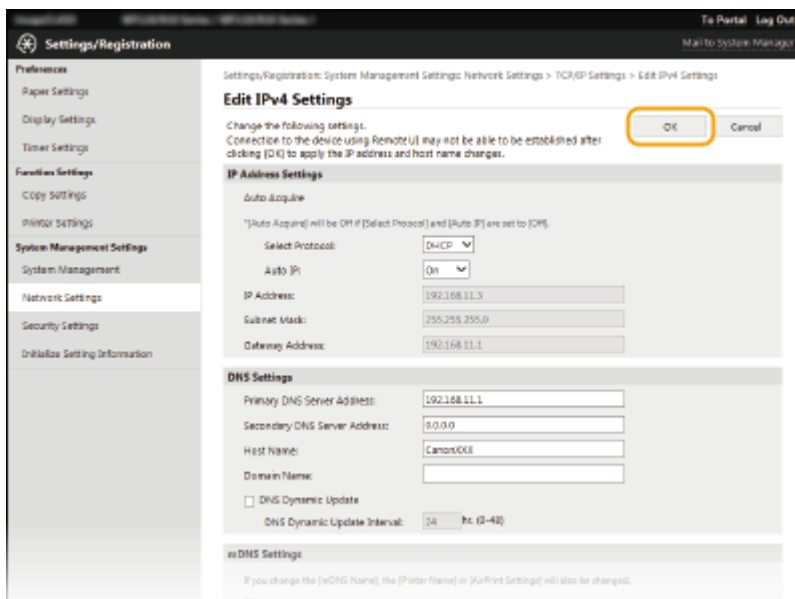

8 Restart the machine as necessary.

- Turn OFF the machine, wait for at least 10 seconds, and turn it back ON.

NOTE:

- For information about whether you need to restart the machine, view the message on the edit screen.



Updating the Firmware

38CS-04X

For the firmware, select the method of update depending on the installation condition of the machine. There are two methods of update: the one is to access the latest firmware version on the Internet from the machine and perform the update if the version currently installed in the machine is not the latest, and the other is to access the latest firmware version on the Internet from a computer and perform the update from the computer if the version currently installed in the machine is not the latest. In an environment where connection to the Internet cannot be established via a wireless LAN, establish connection via a wired LAN or USB and perform the update from the computer.

Installation Condition of the Machine	How to Install the Update
Wireless LAN connection	▶ Updating via the Internet(P. 208)
Wired LAN connection	▶ Updating via the Internet(P. 208) ▶ Updating from a Computer(P. 209)
USB connection	▶ Updating from a Computer(P. 209)

IMPORTANT

- If you are in an IPv6 environment, you cannot perform firmware update. Use USB to re-establish connection, and perform the update from the computer.

NOTE

Checking the firmware version

- You can check the firmware version from the operation panel of the machine. After completion of the firmware update operation, make sure that the update was performed correctly. ▶ **Checking the Firmware Version(P. 209)**

Updating via the Internet

You can access the Canon server from the machine to update the firmware to the latest version.

1 Select <Menu> in the Home screen. ▶ **Home Screen(P. 78)**

2 Select <System Management Settings>.

- If the screen for entering a PIN appears, enter the correct PIN. ▶ **Setting the System Manager PIN(P. 164)**

3 Select <Update Firmware>.

4 Select <Via Internet>.

⇒ A check for existence of the latest firmware is performed.

NOTE:

- If the <This is the latest firmware version.> message is displayed, there is no need to update the firmware.

5 Check the message and select <Yes>.

6 When a license screen appears, press .

7 Select <OK>.

⇒ When the firmware update is complete, the machine restarts automatically.

IMPORTANT:

- Do not turn OFF the machine while the restart is in progress.

Updating from a Computer

When you have downloaded the latest firmware version from the Canon website, use "User Support Tool" utility software to update the firmware from a computer. For how to perform firmware update from a computer, see the "User Support Tool Operation Guide" included with the firmware.

To Put the Machine into a Firmware Update Waiting State

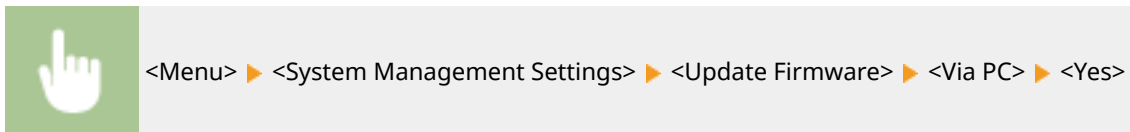

Checking the Firmware Version

1 Select <Menu> in the Home screen. ▶ Home Screen(P. 78)

2 Select <System Management Settings>.

- If the screen for entering a PIN appears, enter the correct PIN. ▶ Setting the System Manager PIN(P. 164)

3 Select <Update Firmware>.

4 Select <Version Information>.

⇒ The current firmware version is displayed.

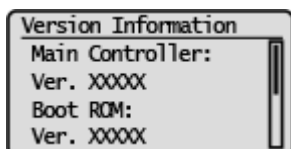

Initializing Settings

38CS-04Y



You can restore the following settings:

- ▶ **Initializing Eco Report Counter(P. 210)**
- ▶ **Initializing Menu(P. 210)**
- ▶ **Initializing Key and Certificate(P. 210)**
- ▶ **Initializing All Data/Settings(P. 211)**

Initializing Eco Report Counter

You can restore the Eco Report Counter settings to the factory defaults.



<Menu> ▶ <System Management Settings> ▶ <Initialize Eco Report Counter> ▶ <Yes>

Initializing Menu

You can restore the settings of the machine (▶ **Setting Menu List(P. 213)**). Depending on the settings selected, you may need to restart the machine after initialization.



<Menu> ▶ <System Management Settings> ▶ <Initialize Menu> ▶ Select the item you want to initialize ▶ <Yes> ▶ Restart the machine if necessary

NOTE

- You can restore the settings only for <Network Settings>.
 - <Menu> ▶ <Network Settings> ▶ <Initialize Network Settings> ▶ <Yes> ▶ Restart the machine

Initializing Key and Certificate

You can restore the settings of the key and certificate and the CA certificate. Note that all the keys and certificates and CA certificates that you registered in the machine (except the preinstalled keys and CA certificates) will be deleted after initializing.

NOTE

- After initializing, functions that require a key and certificate such as TLS encrypted communication are not available. To use these functions, configure the settings for the key and certificate and activate the functions again.



Log in to the Remote UI with Administrator privileges ([▶ Starting Remote UI\(P. 198\)](#)) ▶ [Settings/Registration] ▶ [Initialize Setting Information] ▶ [Initialize Key and Certificate] ▶ [Initialize] ▶ [OK]

Initializing All Data/Settings

This enables restoration of all data and machine settings, including logs, to the factory default values. This prevents sensitive data from being leaked when replacing or disposing of the machine. When the initialization process finishes, the machine automatically restarts.

IMPORTANT

- Before initializing, make sure that there are no documents being processed or waiting to be processed. These documents will be deleted when initialization is performed.
- To use the machine after initializing it, you need to configure all settings from the beginning.



<Menu> ▶ <System Management Settings> ▶ <Initialize All Data/Settings> ▶ <Yes> ▶ <Yes>

LINKS

[▶ Configuring the Key and Certificate for TLS\(P. 179\)](#)

Setting Menu List

Setting Menu List	213
<Network Settings>	214
<Preferences>	223
<Timer Settings>	227
<Copy Settings>	231
<Scan Settings>	233
<Printer Settings>	234
<Adjustment/Maintenance>	236
<System Management Settings>	241

Setting Menu List

38CS-050

You can customize the machine based on your environment and needs by configuring settings described in this chapter. To start configuration, select <Menu> on the Home screen (▶ **Home Screen(P. 78)**). This section describes what each item in the setting menu can configure.

TIPS

- You can print the setting menu in list form to check the current settings: ▶ **Printing Lists of Settings(P. 266)**

<Network Settings>

All the settings related to the network are listed with descriptions. Default settings are marked with a dagger (†).

- ▶<Select Wired/Wireless LAN>(P. 214)
- ▶<Wireless LAN Settings>(P. 214)
- ▶<Direct Connection Settings>(P. 215)
- ▶<Easy Connection via PC> (P. 216)
- ▶<TCP/IP Settings> (P. 217)
- ▶<SNMP Settings>(P. 220)
- ▶<Dedicated Port Settings> (P. 221)
- ▶<Waiting Time for Connection at Startup>(P. 221)
- ▶<Ethernet Driver Settings>(P. 222)
- ▶<IEEE 802.1X Settings>(P. 222)
- ▶<Initialize Network Settings>(P. 222)

NOTE

Asterisks (*)

- Settings marked with an asterisk (*) may not be displayed depending on the model you are using or other setting items.

<Select Wired/Wireless LAN>

When switching the machine from Wireless LAN to Wired LAN, you need to specify the setting. Conversely, when switching the machine from Wired LAN to Wireless LAN, you do not need to specify this setting (You can switch using the following <Wireless LAN Settings>). ▶<Selecting Wired LAN or Wireless LAN>(P. 13)

<Wired LAN> †
<Wireless LAN>

<Wireless LAN Settings>

Specify settings for connecting the machine to a wireless LAN. You can also view the current settings or specify the setting for saving power consumption.

<SSID Settings>

Select to configure a wireless connection by specifying information including an SSID or a network key by inputting manually from the operation panel.

<Select Access Point>

Wireless LAN routers that can access the machine are automatically located, so you can select from the list. You must manually enter a network key, such as a WEP key or a PSK. ▶<Setting Up Connection by Selecting a Wireless Router>(P. 21)

<Enter Manually>

Select to configure a wireless connection by manually entering an SSID. By using this method, you can specify authentication and encryption settings in detail. ▶<Setting Up Connection by Specifying Detailed Settings>(P. 23)

<Security Settings>

<None>
 <WEP>
 <Open System> †
 WEP Key 1 to 4
 <Shared Key>
 WEP Key 1 to 4
 <WPA/WPA2-PSK>
 <Auto> †
 <AES-CCMP>

<WPS Push Button Mode>

Select to automatically configure a wireless connection by using the button on a WPS wireless router. **▶Setting Up Connection Using WPS Push Button Mode(P. 17)**

<WPS PIN Code Mode>

Select to configure a wireless connection by entering a PIN code for a WPS wireless router. **▶Setting Up Connection Using WPS PIN Code Mode(P. 19)**

<Power Save Mode>

Select whether or not the machine enters Power Save Mode based on signals emitted from the wireless router.

<Off>
 <On> †



<Menu> ▶ <Network Settings> ▶ <Wireless LAN Settings> ▶ Read the displayed message ▶
 <OK> ▶ <Power Save Mode> ▶ Select <Off> or <On>

<Wireless LAN Information>

Select to view the current wireless LAN settings. **▶Viewing Network Settings(P. 34)**

<MAC Address>
 <Wireless LAN Status>
 <Latest Error Information>
 <Channel>
 <SSID Settings>
 <Security Settings>
 <Power Save Mode>

<Direct Connection Settings>

Set whether to connect directly. By enabling this function, connecting directly with the machine is possible even in an environment without an access point or wireless LAN router. **▶Connecting Directly (Access Point Mode)(P. 142)**

<Use Direct Connection>
 <Off> †
 <On>
 <Direct Connection Only> *
 <Wireless LAN/Direct Conn. (Auto Switch)> *

<Time Until Direct Connection Termination>

Specify the time to automatically disconnect after Direct Connection is established.

0 (Do not terminate session automatically)
1 to 10 + to 60 (min.)



<Menu> ▶ <Network Settings> ▶ <Direct Connection Settings> ▶ <Time Until Direct Connection Termination> ▶ Enter the time ▶ **OK**

<Access Point Mode Settings>

Configure the SSID/network key arbitrarily. If you want to connect multiple mobile devices to the machine at the same time, you need to configure both SSID and network key arbitrarily.

<Use Custom SSID>

<Off> +

<On>

<SSID>

<Use Custom Network Key>

<Off> +

<On>

<Network Key>



<Menu> ▶ <Network Settings> ▶ <Direct Connection Settings> ▶ <Access Point Mode Settings> ▶ <Use Custom SSID>/<Use Custom Network Key> ▶ <On> ▶ Enter the SSID/network key ▶ <Apply>

<Easy Connection via PC>

Start Easy Connection via PC (cableless setup mode). This allows you to use Canon Laser NW Device Setup Utility on your PC to configure network settings.



<Menu> ▶ <Network Settings> ▶ <Easy Connection via PC> ▶ Start connecting

NOTE

- "Canon Laser NW Device Setup Utility" is available on the Canon website (<http://www.canon.com/>).

<TCP/IP Settings>

Specify settings for using the machine in a TCP/IP network, such as IP address settings.

<IPv4 Settings>

Specify settings for using the machine in an IPv4 network.

<IP Address Settings>

Configure the IP address, which is used for identifying devices, such as computers and printers, on a TCP/IP network. ▶ **Setting IPv4 Address(P. 28)**

<Auto Acquire>
 <Select Protocol>
 <Off>
 <DHCP> †
 <BOOTP>
 <RARP>
 <Auto IP>
 <Off>
 <On> †

<Manually Acquire>
 <IP Address>: 0.0.0.0
 <Subnet Mask>: 0.0.0.0
 <Gateway Address>: 0.0.0.0

<Check Settings>
 <Auto Acquire>*
 <IP Address>
 <Subnet Mask>
 <Gateway Address>

<PING Command>

Select to check that the machine is connected to a computer over a network. ▶ **Testing the Network Connection(P. 29)**

<DNS Settings>

Specify settings for Domain Name System (DNS), which provides a host name for IP address resolutions. ▶ **Configuring DNS(P. 51)**

<DNS Server Settings>
 <Primary DNS Server>: 0.0.0.0
 <Secondary DNS Server>: 0.0.0.0

<DNS Host Name/Domain Name Settings>
 <Host Name>
 <Domain Name>

<DNS Dynamic Update Settings>
 <Off> †
 <On>
 <DNS Dyn. Updt. Intrvl.>
 0 to 24 † to 48 (hr.)

<DHCP Option Settings>

If DHCP is enabled, use these settings to select whether to use the DHCP optional functions to acquire the host name and to use the dynamic update function. **▶Configuring DNS(P. 51)**

<p><Acquire Host Name> <Off> <On> †</p> <p><DNS Dynamic Update> <Off> † <On></p>
--

<IPv6 Settings>

Specify settings for using the machine in an IPv6 network.

<Use IPv6>

Enable or disable IPv6 in the machine. You can also view the current settings. **▶Setting IPv6 Addresses(P. 31)**

<p><Off> †</p> <p><On></p> <p><Check Settings> <Link-Local Address> <Prefix Length></p>
--

<Stateless Address Settings>

Enable or disable stateless addresses. **▶Setting IPv6 Addresses(P. 31)**

<p><Off></p> <p><On> †</p> <p><Check Settings> <Stateless Address> <Prefix Length></p>

<Use DHCPv6>

Enable or disable the stateful address that is acquired via DHCPv6. **▶Setting IPv6 Addresses(P. 31)**

<p><Off> †</p> <p><On></p> <p><Check Settings> <Stateful Address> <Prefix Length></p>
--

<DNS Settings>

Specify settings for Domain Name System (DNS), which provides a host name for IP address resolutions. **▶Configuring DNS(P. 51)**

<p><DNS Host Name/Domain Name Settings></p>
--

<Use IPv4 Host/Domain>
 <Off>
 <Host Name>
 <Domain Name>
 <On> †

<DNS Dynamic Update Settings>
 <Off> †
 <On>
 <Register Manual Address>
 <Off> †
 <On>
 <Register Stateful Address>
 <Off> †
 <On>
 <Register Stateless Address>
 <Off> †
 <On>
 <DNS Dynamic Update Interval>
 0 to 24 † to 48 (hr.)

<LPD Print Settings>

Enable or disable LPD, a printing protocol that can be used on any hardware platform or operating system. ▶ **Configuring Printing Protocols and WSD Functions(P. 37)**

<Off>
 <On> †

<RAW Print Settings>

Enable or disable RAW, a Windows specific printing protocol. ▶ **Configuring Printing Protocols and WSD Functions(P. 37)**

<Off>
 <On> †

<WSD Settings>

Enable or disable automatic browsing and acquiring information for the printer or scanner by using the WSD protocol. ▶ **Configuring Printing Protocols and WSD Functions(P. 37)**

<WSD Print Settings>
 <Use WSD Print>
 <Off>
 <On> †
 <Use WSD Browsing>
 <Off>
 <On> †

<WSD Scan Settings>
 <Use WSD Scan>
 <Off> †
 <On>

<Use Computer Scan>

<Off> †

<On>

<Use Multicast Discovery>

<Off>

<On> †

<Use HTTP>

Enable or disable HTTP, which is required for communications with a computer, such as when using the Remote UI, WSD printing, or printing with Google Cloud Print. [▶Disabling HTTP Communication\(P. 195\)](#)

<Off>

<On> †

<Port Number Settings>

Change port numbers for protocols according to the network environment. [▶Changing Port Numbers\(P. 176\)](#)

<LPD>

1 to 515 † to 65535

<RAW>

1 to 9100 † to 65535

<WSD Multicast Discovery>

1 to 3702 † to 65535

<HTTP>

1 to 80 † to 65535

<SNMP>

1 to 161 † to 65535

<MTU Size>

Select the maximum size of packets the machine receives. [▶Changing the Maximum Transmission Unit\(P. 49\)](#)

<1300>

<1400>

<1500> †

<SNMP Settings>

Specify the settings for monitoring and controlling the machine from a computer running SNMP-compatible software. [▶Monitoring and Controlling the Machine with SNMP\(P. 54\)](#)

<SNMPv1 Settings>

Enable or disable SNMPv1. When enabling SNMPv1, specify a community name and access privileges to Management Information Base (MIB) objects.

<Off>

<On> †



<Menu> ▶ <Network Settings> ▶ <SNMP Settings> ▶ <SNMPv1 Settings> ▶ Select <Off> or <On>

<SNMPv3 Settings>

Enable or disable SNMPv3. Use the Remote UI to specify detailed settings that are applied when SNMPv3 is enabled.

<Off> +
<On>



<Menu> ▶ <Network Settings> ▶ <SNMP Settings> ▶ <SNMPv3 Settings> ▶ Select <Off> or <On>

<Acquire Printer Mngt. Info. from Host>

Enable or disable the monitoring of printer management information from a networked computer running SNMP-compatible software.

<Off> +
<On>



<Menu> ▶ <Network Settings> ▶ <SNMP Settings> ▶ <Acquire Printer Mngt. Info. from Host> ▶ Select <Off> or <On>

<Dedicated Port Settings>

Enable or disable the dedicated port. The dedicated port is used when printing or scanning uses MF Scan Utility and when browsing or specifying the machine settings over the network.

<Off>
<On> +



<Menu> ▶ <Network Settings> ▶ <Dedicated Port Settings> ▶ Select <Off> or <On>

<Waiting Time for Connection at Startup>

Specify a wait time for connecting to a network. Select the setting depending on the network environment. **Setting a Wait Time for Connecting to a Network(P. 50)**

0 + to 300 (sec.)

<Ethernet Driver Settings>

Select the Ethernet type (10BASE-T/100BASE-TX) and the communication mode of Ethernet (half-duplex/full-duplex). You can also view the MAC address for wired LAN.

<Auto Detect>

Select whether to automatically detect or manually select the communication mode and the Ethernet type. ▶ **Configuring Ethernet Settings(P. 47)**

```
<Off>
  <Communication Mode>
    <Half Duplex> †
    <Full Duplex>
  <Ethernet Type>
    <10BASE-T> †
    <100BASE-TX>
<On> †
```

<MAC Address>

Check the MAC address of the machine, which is a number unique to each communication device. ▶ **Viewing the MAC Address for Wired LAN(P. 34)**

<IEEE 802.1X Settings>

Enable or disable IEEE 802.1X authentication. ▶ **Configuring IEEE 802.1X Authentication Settings(P. 189)**

```
<Off> †
<On>
```



<Menu> ▶ <Network Settings> ▶ <IEEE 802.1X Settings> ▶ Select <Off> or <On> ▶ Restart the machine

<Initialize Network Settings>

Select to return the Network Settings to the factory defaults. ▶ **<Initialize Menu>(P. 247)**

<Preferences>

38CS-052

All the settings related to viewing of the display are listed with descriptions. Default settings are marked with a dagger (†).

NOTE

Asterisks (*)

- Settings marked with "*1" may be unavailable or vary or have different defaults depending on your country or region.
- Settings marked with "*2" may not be displayed depending on the model you are using or other setting items.

<Display Settings>

<Default Screen after Startup/Restoration>

By default, the Home screen is displayed immediately after the machine is turned ON or when the Auto Reset function is performed. Specify the setting to change the default screen and display the main screen of a different function.

<Home> †
<Copy>
<Scan>



<Menu> ▶ <Preferences> ▶ <Display Settings> ▶ <Default Screen after Startup/Restoration> ▶
Select a function to display the desired screen

<Button Display Order on Home Screen>

Configure the settings for the buttons displayed in the Home screen. You can rearrange the order in which the buttons appear. [▶ Customizing the Home Screen\(P. 100\)](#)

<Contrast>

Adjust the contrast (the difference between the light and dark parts) of the display to suit the installation location of the machine.

Five Levels



<Menu> ▶ <Preferences> ▶ <Display Settings> ▶ <Contrast> ▶ Adjust the contrast ▶ **OK**

<Invert Screen Colors>

Select <On> to invert the display colors. Select <On> if the display is hard to view even after the brightness was adjusted in <Contrast>.

<Off> [†]
<On>



<Menu> ▶ <Preferences> ▶ <Display Settings> ▶ <Invert Screen Colors> ▶ Select <Off> or <On>

<Millimeter/Inch Entry Switch>

Select the unit of measurement.

<Millimeter> [†]
<Inch>



<Menu> ▶ <Preferences> ▶ <Display Settings> ▶ <Millimeter/Inch Entry Switch> ▶ Select <Millimeter> or <Inch>

<Notify to Check Paper Settings>

Specify whether to display a message prompting you to check paper settings when loading paper into the drawer.

<Off>
<On> [†]





<Menu> ▶ <Preferences> ▶ <Display Settings> ▶ <Notify to Check Paper Settings> ▶ Select <Off> or <On>

<Message Display Time>

Specify the interval in seconds at which two different messages are alternately displayed.

1 to 2 [†] to 5 (sec.)



<Menu> ▶ <Preferences> ▶ <Display Settings> ▶ <Message Display Time> ▶ Enter a number for the interval ▶ 

<Scrolling Speed>

Adjust the scrolling speed of the screen by selecting from three levels.

<Slow>
 <Standard> †
 <Fast>



<Menu> ▶ <Preferences> ▶ <Display Settings> ▶ <Scrolling Speed> ▶ Select the speed

<Language> *1

Select the display language used for the display, reports, and lists.

<Chinese (Simplified)>
 <Chinese (Traditional)>
 <English> †
 <French>
 <German>
 <Italian>
 <Japanese>
 <Korean>
 <Malay>
 <Portuguese>
 <Spanish>
 <Thai>
 <Vietnamese>



<Menu> ▶ <Preferences> ▶ <Display Settings> ▶ <Language> ▶ Select a language

<Remote UI Language> *1*2

Select the display language used for the Remote UI screens.

<Chinese (Simplified)>
 <Chinese (Traditional)>
 <English> †
 <French>
 <German>
 <Italian>
 <Japanese>
 <Korean>
 <Portuguese>
 <Spanish>



<Menu> ▶ <Preferences> ▶ <Display Settings> ▶ <Remote UI Language> ▶ Select a language

<Timer Settings>

All the settings related to the timer are listed with descriptions. Default settings are marked with a dagger (†).

- ▶<Date/Time Settings>(P. 227)
- ▶<Auto Sleep Time>(P. 228)
- ▶<Auto Reset Time>(P. 229)
- ▶<Function After Auto Reset>(P. 229)
- ▶<Auto Offline Time>(P. 229)

NOTE

Asterisks (*)

- Settings marked with "*" may be unavailable or vary or have different defaults depending on your country or region.
- Settings marked with "*2" may not be displayed depending on the model you are using or other setting items.

<Date/Time Settings> *2

Specify date and time settings, including the date format and the 12- or 24-hour clock display setting.

<Date Format>

Select the date format (order of year, month, and day).

<YYYY MM/DD>
 <MM/DD/YYYY>
 <DD/MM YYYY> †



<Menu> ▶ <Timer Settings> ▶ <Date/Time Settings> ▶ <Date Format> ▶ Select the date format

<Time Format>

Select the 12- or 24-hour clock display setting.

<12 Hour (AM/PM)> †
 <24 Hour>



<Menu> ▶ <Timer Settings> ▶ <Date/Time Settings> ▶ <Time Format> ▶ Select the display setting

<Current Date/Time Settings>

Set the current date and time. **▶Setting the Date/Time(P. 9)**

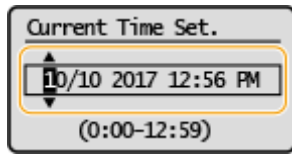
**IMPORTANT**

- Set <Time Zone> before setting the current date and time. If the <Time Zone> setting is changed, the current date and time are also changed accordingly.

NOTE

- The current date and time cannot be changed for 1 hour after daylight saving time is in effect.

<Time Zone> *1

Select the time zone. If the time zone setting is changed, the values set in <Current Date/Time Settings> are also changed accordingly. **▶Setting the Date/Time(P. 9)**

<(UTC-12:00) International Date Line West> to <(UTC) Coordinated Universal Time> **+** to <(UTC+14:00) Kiritimati Island>

NOTE**UTC**

- Coordinated Universal Time (UTC) is the primary time standard by which the world regulates clocks and time. The correct UTC time zone setting is required for Internet communications.

<Daylight Saving Time Settings> *1

Enable or disable daylight saving time. If daylight saving time is enabled, specify the dates from which and to which daylight saving time is in effect. **▶Setting the Date/Time(P. 9)**

<Off>

<On> **+**

Start: Month, Week, Day

End: Month, Week, Day

<Auto Sleep Time>

If the machine has not been operated or has had no data to process for a specified period of time, the machine enters sleep mode to save energy consumption (Auto Sleep). Specify the period of time after which auto sleep is performed. Auto Sleep is not performed when the setting menu is displayed. We recommend using the factory default settings to save the most power. **▶Entering Sleep Mode(P. 102)**

1 **+** to 30 (min.)

<Auto Reset Time>

If a key is not pressed for a specified period of time, the screen and the settings are initialized to display the default screen (Auto Reset). Specify the interval at which the Auto Reset is performed. The Auto Reset is not performed in the following cases:

- The setting menu is displayed.
- The machine is processing data, such as when printing documents.
- An error message is displayed and the [Error] indicator is blinking (However, Auto Reset is performed when the error does not prevent the user from continuing to use a function.)

0 (Auto Reset is disabled.)
1 to 2 ↑ to 9 (min.)



<Menu> ▶ <Timer Settings> ▶ <Auto Reset Time> ▶ Specify the Auto Reset time ▶ OK

NOTE

- The screen displayed after the Auto Reset is performed can be selected in <Function After Auto Reset>.

<Function After Auto Reset>

Select whether to return the display to the default screen after the Auto Reset is performed. If <Default Function> is selected, the main screen of the function selected in <Default Screen after Startup/Restoration> is displayed (▶ <Default Screen after Startup/Restoration>(P. 223)). If <Selected Function> is selected, the display returns to the main screen of the function that was selected.

<Default Function> ↑
<Selected Function>



<Menu> ▶ <Timer Settings> ▶ <Function After Auto Reset> ▶ Select <Default Function> or <Selected Function>

<Auto Offline Time>

If scan is not performed within a specified period of time after the screen below is displayed (the machine is set online for scanning), the machine automatically becomes offline. Specify the time period at which the machine becomes offline. You can also set the machine to remain online.

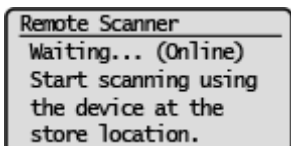

Setting Menu List

0 (The machine remains online.)
1 to 5 + to 60 (min.)



<Menu> ▶ <Timer Settings> ▶ <Auto Offline Time> ▶ Set the time period ▶ **OK**

<Copy Settings>

38CS-054

All the settings related to the copy are listed with descriptions. Default settings are marked with a dagger (†).

- ▶<Change Default Settings>(P. 231)
- ▶<Correct Density>(P. 232)
- ▶<Initialize Default Settings>(P. 232)

<Change Default Settings>

You can change the default settings about copy. The selected settings are used as the default settings of the copy function. ▶<Changing the Default Settings for Functions>(P. 101)

<Number of Copies>

1 † to 999

<Density>

Nine Levels

<Auto Density>

<Original Type>

<Text>

<Text/Photo (High Speed)> †

<Text/Photo>

<Photo>

<Copy Ratio>

<Custom Ratio>

<100% (1:1)> †

<400% (Max)>

<200%>

<141% A5->A4/LTR>

<122% A5->B5>

<115% B5->A4/LTR>

<86% A4/LTR->B5>

<81% B5->A5>

<70% A4/LTR->A5>

<50%>

<25% (Min)>

<N on 1>

<Off> †

<2 on 1>

<4 on 1>

<ID Card Copy>

<Select Layout>

<Collate>

<Off> †
 <On>

<Sharpness>
 Seven Levels

<Correct Density>

Specify the initial copy density. You can also change the copy density temporarily.  **Basic Copy Operations(P. 105)**

Nine Levels



<Menu> ▶ <Copy Settings> ▶ <Correct Density> ▶ Adjust the density ▶ 

<Initialize Default Settings>

Select to restore the default copy settings.



<Menu> ▶ <Copy Settings> ▶ <Initialize Default Settings> ▶ <Yes>

<Scan Settings>

All the settings related to the scan are listed with descriptions. Default settings are marked with a dagger (†).

NOTE

Asterisks (*)

- Settings marked with an asterisk (*) may not be displayed depending on the model you are using or other setting items.

<Shortcut Key Settings>

Register scan settings for the <Scan -> PC1> and <Scan -> PC2>. The settings include the computer that scanned images are saved in, the type of scan (color or black and white), and the file format (PDF or JPEG). Registering these settings enables you to scan documents into a specified computer just by selecting a shortcut key. You can view the registered settings by selecting <Confirm Destination>. **▶ Scanning Using the Shortcut Key(P. 130)**

<Register>

<Scan -> PC1>

<Off> †

<USB Connection>

<Color Scan>

<Black & White Scan>

<Custom 1>

<Custom 2>

<Network Connection>*

<Color Scan>

<Black & White Scan>

<Custom 1>

<Custom 2>

<Scan -> PC2>

<Off> †

<USB Connection>

<Color Scan>

<Black & White Scan>

<Custom 1>

<Custom 2>

<Network Connection>*

<Color Scan>

<Black & White Scan>

<Custom 1>

<Custom 2>

<Confirm Destination>

<Scan -> PC1>

<Scan -> PC2>

<Printer Settings>

All the settings related to the printer are listed with descriptions. Default settings are marked with a dagger (†).

- ▶<Action When Paper Size Mismatch>(P. 234)
- ▶<Image Quality Settings for Mobile Print>(P. 234)
- ▶<Print Quality>(P. 235)

NOTE

Asterisks (*)

- Settings marked with an asterisk (*) may not be displayed depending on the model you are using or other setting items.

Priority of settings

- If a print setting is specified both from the printer driver and the operation panel of the machine, the specification from the printer driver overrides that from the operation panel. The specification from the operation panel becomes effective in some specific cases, such as when printing from UNIX or other operating system that does not support printer drivers.



<Action When Paper Size Mismatch>

Set whether printing goes ahead if a paper size other than the size loaded in the drawer is selected. You can also set the machine not to go ahead with printing and instead display an alert message.

<Force Output>
<Display Error> †



<Menu> ▶ <Printer Settings> ▶ <Action When Paper Size Mismatch> ▶ Select <Force Output> or <Display Error>

<Image Quality Settings for Mobile Print> *

Select the image processing when printing from a mobile device.

<Halftone>
<Gradation> †
<Error Diffusion>
<Priority>
<Standard> †
<Speed Priority>

<Image Quality Priority>



<Menu> ▶ <Printer Settings> ▶ <Image Quality Settings for Mobile Print> ▶ Select <Halftone> or <Priority> ▶ Select the item ▶ <Apply>

NOTE

- When <Priority> is set to <Standard> or <Speed Priority>, you cannot select <Error Diffusion>.

<Print Quality>

You can change settings related to print quality.

<Toner Save>

You can save toner consumption when printing from a mobile device. Select <On> when you want to check the layout or other appearance characteristics before proceeding to final printing of a large job.

<Off> †

<On>



<Menu> ▶ <Printer Settings> ▶ <Print Quality> ▶ <Toner Save> ▶ Select <Off> or <On>

<Adjustment/Maintenance>

All the settings related to adjustment and maintenance are listed with descriptions. Default settings are marked with a dagger (†).

- ▶<Displ. Timing for Cartridge Prep. Notif.> (P. 236)
- ▶<Toner Save>(P. 236)
- ▶<Special Processing>(P. 236)
- ▶<Clean Fixing Assembly> (P. 240)

<Displ. Timing for Cartridge Prep. Notif.>

Set the display timing for the message notifying you that the amount remaining in the drum cartridges is low.

<Drum Cartridge>



<Menu> ▶ <Adjustment/Maintenance> ▶ <Displ. Timing for Cartridge Prep. Notif.> ▶ <Drum Cartridge> ▶ Enter the cartridge level ▶ **OK**

<Toner Save>

Select whether to reduce toner consumption when copying.

<Copy>
<Off> †
<On>



<Menu> ▶ <Adjustment/Maintenance> ▶ <Toner Save> ▶ <Copy> ▶ <On>

NOTE

- Fine lines and portions with lighter print density may be blurred when you set this to <On>.

<Special Processing>

If the print results on special types of paper are not satisfactory, the following settings may improve the quality of the printouts.

<Special Printing Mode U>

Sometimes toner appears splattered around text or patterns in a printout. In such cases, setting this to <On> may improve the quality of the printout.

<Off> [†] <On>



 <Menu> ▶ <Adjustment/Maintenance> ▶ <Special Processing> ▶ <Special Printing Mode U>
 ▶ <On>

NOTE

- Setting this to <On> may affect the print quality for some types of paper (especially for lightweight paper) or in some printing environments (especially in high humidity environments).
- When you set this to <On>, <Special Printing Mode Q>, <Special Printing Mode R>, and <Special Printing Mode T> are set to <Off> automatically.

<Special Printing Mode A>

If streaks adhere to the print paper, changing this may improve the print quality. <Mode 2> can improve the quality more significantly than <Mode 1>.

<Off> [†] <Mode 1> <Mode 2>
--



 <Menu> ▶ <Adjustment/Maintenance> ▶ <Special Processing> ▶ <Special Printing Mode A>
 ▶ Select the mode

<Special Printing Mode Z>

If streaks adhere to the print paper output when copying, changing this may improve the print quality. <Mode 2> can improve the quality more significantly than <Mode 1>.

<Off> [†] <Mode 1> <Mode 2>
--



 <Menu> ▶ <Adjustment/Maintenance> ▶ <Special Processing> ▶ <Special Printing Mode Z> ▶
 Select the mode

<Special Printing Mode G>

Printed images may fade or streaks may appear when the paper has a lot of paper dust. In such cases, setting this to <On> may improve the quality of the printout.

<Off> †
<On>



<Menu> ▶ <Adjustment/Maintenance> ▶ <Special Processing> ▶ <Special Printing Mode G>
▶ <On>

<Special Printing Mode Q>

Printed images may be faint when they are printed on rough-surface paper. In such cases, setting this to <On> may improve the quality of the printout.

<Off> †
<On>



<Menu> ▶ <Adjustment/Maintenance> ▶ <Special Processing> ▶ <Special Printing Mode Q>
▶ <On>

NOTE

- Setting this to <On> may affect the image quality.
- When you set this to <On>, <Special Printing Mode U>, <Special Printing Mode R>, and <Special Printing Mode T> are set to <Off> automatically.

<Special Printing Mode R>

Printing may be faint when you print on the back of a printed sheet. In such cases, setting this to <On> may improve the quality of the printout.

<Off> †
<On>



<Menu> ▶ <Adjustment/Maintenance> ▶ <Special Processing> ▶ <Special Printing Mode R>
▶ <On>

NOTE

- If you set to <On>, image quality may be affected or a paper jam may occur when a certain length of time elapses after printing on the front side or depending on the ambient humidity.

- When you set this to <On>, <Special Printing Mode U>, <Special Printing Mode Q>, and <Special Printing Mode T> are set to <Off> automatically.

<Special Printing Mode T>

Printing may be uneven when you print in a high-humidity environment. In such cases, setting this to <On> may improve the quality of the printout.

<Off> †
<On>



<Menu> ▶ <Adjustment/Maintenance> ▶ <Special Processing> ▶ <Special Printing Mode T>
▶ <On>

NOTE

- Printed images or text may be blurred when you set this to <On> and print in a low-humidity environment.
- When you set this to <On>, <Special Printing Mode U>, <Special Printing Mode Q>, and <Special Printing Mode R> are set to <Off> automatically.

<Special Printing Mode L>

Smudges may appear in a printout when the paper has a lot of paper dust or other dust particles. In such cases, setting this to <On> may improve the quality of the printout.

<Off> †
<On>



<Menu> ▶ <Adjustment/Maintenance> ▶ <Special Processing> ▶ <Special Printing Mode L>
▶ <On>

<Select Line Width>

If a printed barcode cannot be read, changing this may resolve the problem.

<Auto> †
<Thin>
<Slightly Thin>
<Slightly Thick>
<Thick>



<Menu> ▶ <Adjustment/Maintenance> ▶ <Special Processing> ▶ <Select Line Width> ▶ Select the line width

<Clean Fixing Assembly>

Clean the fixing assembly after the toner cartridge or the drum cartridge is replaced or if black streaks appear on printouts. ▶ **Cleaning the Fixing Assembly(P. 254)**

<System Management Settings>

All the settings related to System Management Settings are listed with descriptions. Default settings are marked with a dagger (†).

- ▶<Network Settings>(P. 241)
- ▶<System Manager Information Settings> (P. 241)
- ▶<Device Information Settings> (P. 242)
- ▶<Security Settings>(P. 242)
- ▶<Select Country/Region>(P. 243)
- ▶<Remote UI Settings>(P. 243)
- ▶<Auto Online for Remote Scan>(P. 244)
- ▶<Display Job Log> (P. 244)
- ▶<Use as USB Device>(P. 245)
- ▶<Enable Product Extended Survey Program> (P. 245)
- ▶<Displ. Consmbls. Info (RUI/Toner Status)/<Display Consumables Info. (Toner Status)>(P. 245)
- ▶<Google Cloud Print Settings>(P. 246)
- ▶<PDL Selection (Plug and Play)>(P. 246)
- ▶<Update Firmware>(P. 247)
- ▶<Initialize Eco Report Counter>(P. 247)
- ▶<Initialize Menu>(P. 247)
- ▶<Initialize All Data/Settings>(P. 247)

NOTE

Asterisks (*)

- Settings marked with "*"1" may be unavailable or vary or have different defaults depending on your country or region.
- Settings marked with "*"2" may not be displayed depending on the model you are using or other setting items.

<Network Settings> *2

See ▶<Network Settings>(P. 214) .

<System Manager Information Settings>

Specify the PIN exclusively for Administrators who have access privileges to <Network Settings> and <System Management Settings>. You can set the PIN from <System Manager PIN>. You can also register the name of an Administrator. ▶<Setting the System Manager PIN>(P. 164)

<System Manager PIN>

Enter a number for the System Manager PIN.

<System Manager Name>

Enter alphanumeric characters for the name of an Administrator.

<Device Information Settings>

Enter alphanumeric characters for the name and the installation location to identify the machine.

<Device Name>
<Location>



<Menu> ▶ <System Management Settings> ▶ <Device Information Settings> ▶ Select <Device Name> or <Location> ▶ Enter the device name or location (**Entering Text(P. 83)**) ▶ <Apply>

<Security Settings> *2

Enable or disable settings for IP address or MAC address packet filtering.

<Use TLS>

Select whether to use the TLS encrypted communication. **Configuring the Key and Certificate for TLS(P. 179)**

<Off> †
<On>

<IPv4 Address Filter>

Enable or disable settings for filtering packets received from devices with specified IPv4 addresses. **Specifying IP Addresses for Firewall Settings(P. 171)**

<Inbound Filter>
<Off> †
<On>



<Menu> ▶ <System Management Settings> ▶ <Security Settings> ▶ <IPv4 Address Filter> ▶ <Inbound Filter> ▶ Select <Off> or <On>

<IPv6 Address Filter>

Enable or disable settings for filtering packets received from devices with specified IPv6 addresses. **Specifying IP Addresses for Firewall Settings(P. 171)**

< Inbound Filter>
<Off> †
<On>



<Menu> ▶ <System Management Settings> ▶ <Security Settings> ▶ <IPv6 Address Filter> ▶ <Inbound Filter> ▶ Select <Off> or <On>

<MAC Address Filter>

Enable or disable settings for filtering packets received from devices with specified MAC addresses. ▶
Specifying MAC Addresses for Firewall Settings(P. 174)

<Inbound Filter>
 <Off> †
 <On>



<Menu> ▶ <System Management Settings> ▶ <Security Settings> ▶ <MAC Address Filter> ▶ <Inbound Filter> ▶ Select <Off> or <On>

<Select Country/Region> *1

Specify the country or region where the machine is used. The default setting may vary depending on the setting selected at initial power-on.

<Hong Kong (HK)>
 <Singapore (SG)>
 <Australia (AU)>
 <New Zealand (NZ)>
 <Malaysia (MY)>
 <Vietnam (VN)>
 <Argentina (AR)>
 <Thailand (TH)>
 <India (IN)>
 <Philippines (PH)>
 <Other>
 <Other (Asia)>
 <Other (Latin America)>



<Menu> ▶ <System Management Settings> ▶ <Select Country/Region> ▶ Select a country or region

<Remote UI Settings> *2

Configure settings for using the Remote UI. Using the Remote UI allows you to configure machine settings from a Web browser.

<Use Remote UI>

Select whether to use the Remote UI. **▶ Disabling Remote UI(P. 196)**

<Off>
<On> †



<Menu> ▶ <System Management Settings> ▶ <Remote UI Settings> ▶ <Use Remote UI> ▶ Select <Off> or <On>

<Remote UI Access Security Settings>

Specify so that entry of a PIN is required for access to the Remote UI. Set a PIN of up to 7 digits. All users use a common PIN. **▶ Setting a Remote UI PIN(P. 166)**

<Off> †

<On>
<Remote UI Access PIN>



<Menu> ▶ <System Management Settings> ▶ <Remote UI Settings> ▶ <Remote UI Access Security Settings> ▶ <On> ▶ Enter a PIN ▶ <Apply> ▶ Enter the PIN (Confirm) ▶ <Apply>

<Auto Online for Remote Scan>

When scanning from the computer, use this to specify whether to automatically go online for remote scanning (scan standby mode) without using the operation panel.

<Off>
<On> †



<Menu> ▶ <System Management Settings> ▶ <Auto Online for Remote Scan> ▶ Select <Off> or <On>

<Display Job Log>

Select whether to display printing logs on the machine display.

<Off>
<On> †



<Menu> ▶ <System Management Settings> ▶ <Display Job Log> ▶ Select <Off> or <On>

<Use as USB Device>

Enable or disable the USB port that is used for connecting the machine to a computer. ▶ **Restricting the USB Connection with a Computer (P. 194)**

<Off>
<On> †

<Enable Product Extended Survey Program>

Enable or disable the Product Extended Survey Program (a program for the machine usage survey).

<Off>
<On> †



<Menu> ▶ <System Management Settings> ▶ <Enable Product Extended Survey Program> ▶ Select <Off> or <On>

<Displ. Consmbls. Info (RUI/Toner Status)>/<Display Consumables Info. (Toner Status)>

Set whether to display a button in the Remote UI or Toner Status for accessing the Web site for purchasing toner cartridges, etc. Also set whether to use Toner Status.

<Displ. Consumables Purchase Button (RUI)> *2

<Off>
<On> †

<Toner Status Settings>

<Off>
<On> †
 <Displ. Purchase Button>
 <Off>
 <On> †



<Menu> ▶ <System Management Settings> ▶ <Displ. Consmbls. Info (RUI/Toner Status)> ▶ Specify the settings

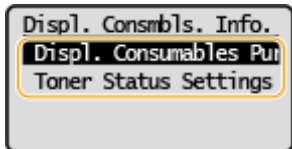

<Displ. Consumables Purchase Button (RUI)>

Select <Off> to prevent a button that accesses sites for purchasing toner cartridges, etc. from being displayed in the Remote UI.

<Toner Status Settings>

If you do not want to use Toner Status, select <Off>. To prevent a button that accesses sites for purchasing toner cartridges, etc. from being displayed in Toner Status, select <On> and then <Off>.

<Google Cloud Print Settings> *2

Enable or disable Google Cloud Print. **▶ Registering the Machine with Google Cloud Print(P. 157)**

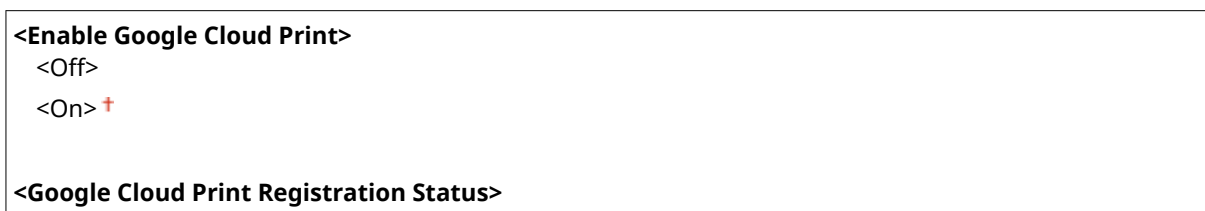

<PDL Selection (Plug and Play)>

Select a page description language so that the machine is detected as a printer that is compatible with that language when it is connected to a computer by using Plug and Play.

<Network> *2

Select a page description language so that the machine is detected as a printer that is compatible with that language when it is detected over the network.



<USB>

Select a page description language so that the machine is detected as a printer that is compatible with that language when it is connected to a computer via USB.



<Menu> ▶ <System Management Settings> ▶ <PDL Selection (Plug and Play)> ▶ Select <Network> or <USB> ▶ Select a page description language ▶ Restart the machine



<UFRII LT>

Detects and connects the machine as a UFRII LT printer.

<UFRII LT (V4)>

Detects and connects the machine as a UFRII LT printer that is compatible with XML Paper Specification (XPS).

<Update Firmware>

Select how to install the firmware update according to the environment of the machine. ▶ **Updating the Firmware(P. 208)**

<Via PC>
<Via Internet>*2
<Version Information>

<Initialize Eco Report Counter>

Select to restore the Eco Report Counter settings to the factory defaults. ▶ **Initializing Eco Report Counter(P. 210)**

<Initialize Menu>

Select to restore the settings listed below to the factory defaults. You can restore all the settings listed below at once, or you can restore individual settings separately. ▶ **Initializing Menu(P. 210)**

<Preferences>
<Timer Settings>
<Copy Settings>
<Scan Settings>
<Printer Settings>
<Adjustment/Maintenance>
<System Management Settings>
<Initialize All>

<Initialize All Data/Settings>

Restores all data including logs and setting values to their default settings. ▶ **Initializing All Data/Settings(P. 211)**

Maintenance

Maintenance	249
Regular Cleaning	251
Cleaning the Exterior	252
Cleaning the Platen Glass	253
Cleaning the Fixing Assembly	254
Replacing the Toner Cartridge	255
Replacing the Drum Cartridge	258
Checking the Remaining Amount of Consumables	262
Relocating the Machine	263
Viewing the Counter Value	265
Printing Reports and Lists	266
Consumables	268

Maintenance

38CS-059

This chapter describes upkeep of the machine, including how to clean the machine and adjustment of print quality.

■ Basic Cleaning



▶ Regular Cleaning(P. 251)

■ Replacing Consumables

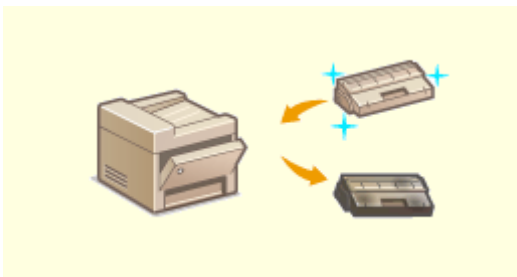

▶ Replacing the Toner Cartridge(P. 255)
▶ Replacing the Drum Cartridge(P. 258)



▶ Checking the Remaining Amount of Consumables(P. 262)



▶ Consumables(P. 268)

■ Adjusting and Managing the Machine

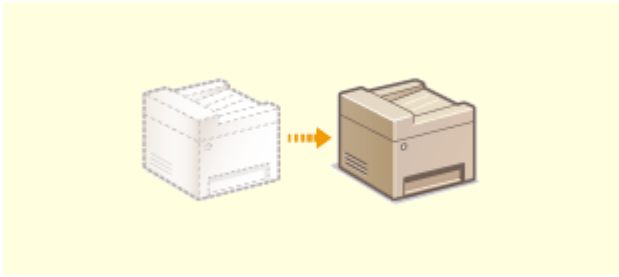

▶ Relocating the Machine(P. 263)

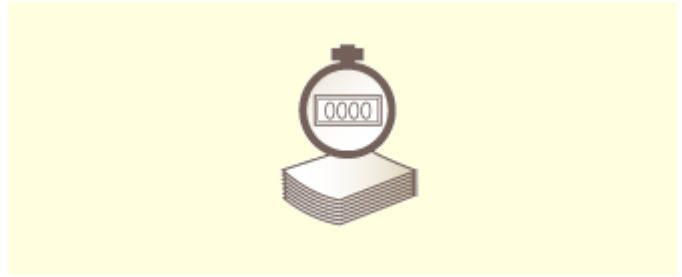

▶ Viewing the Counter Value(P. 265)



▶ Printing Reports and Lists(P. 266)

Regular Cleaning

Regularly clean the machine to prevent deterioration in printing quality and to ensure that you use it safely and easily.

Where to Clean

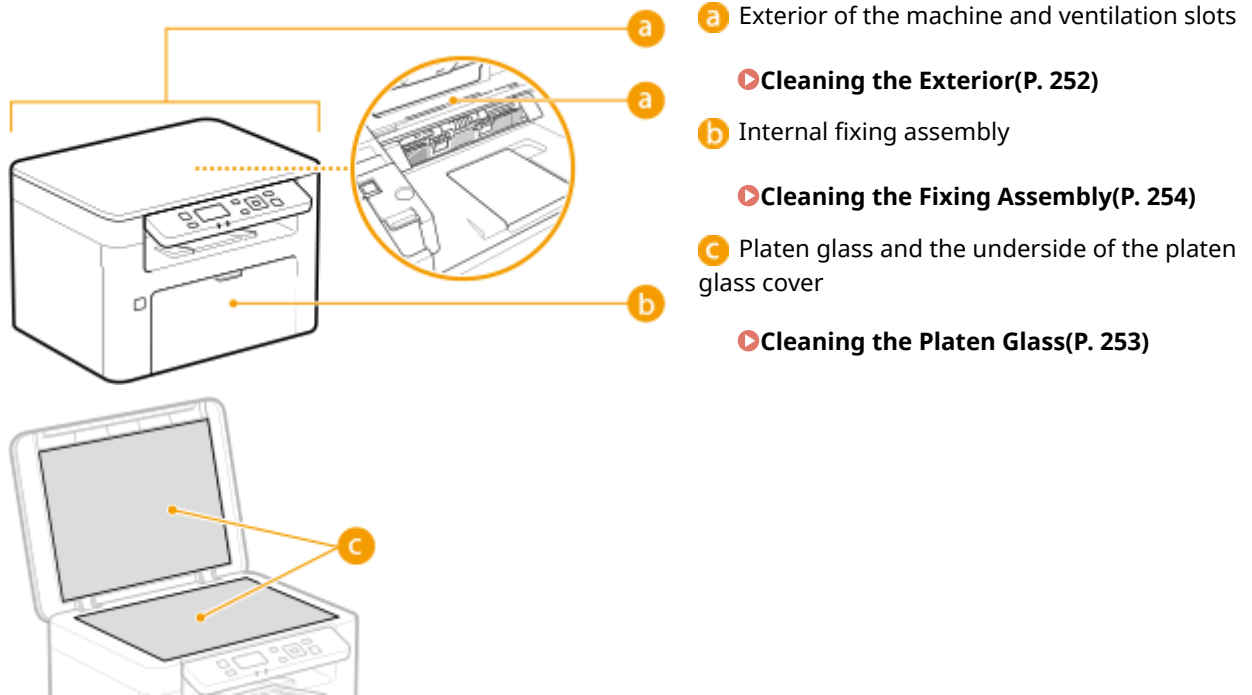

Cleaning the Exterior

38CS-05C

Regularly wipe the exterior of the machine, especially around the ventilation slots, to keep the machine in good condition.

1 Turn OFF the machine, and unplug the power cord from the AC power outlet.

- When you turn OFF the machine, data that is waiting to be printed is deleted.

2 Clean the exterior of the machine and the ventilation slots.

- Use a soft, well-wrung-out cloth dampened with water or a mild detergent diluted with water.
- To locate the ventilation slots, see [▶Front Side\(P. 68\)](#) .

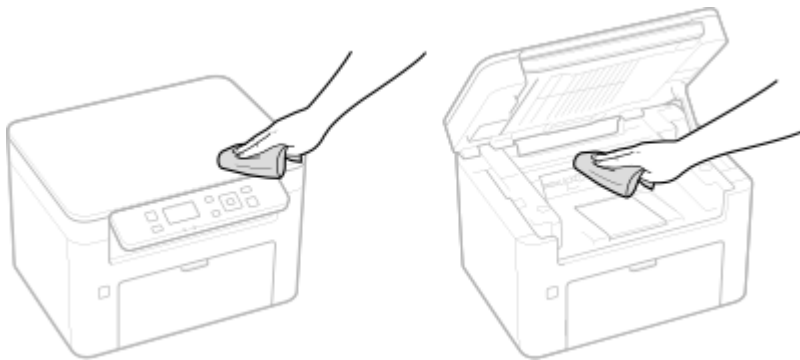

3 Wait for the exterior of machine to dry completely.

4 Reconnect the power cord and turn ON the machine.

Cleaning the Platen Glass

38CS-05E

Regularly wipe off the dust from the platen glass and the underside of the platen glass cover to prevent smudges to be printed on originals or printouts.

1 Turn OFF the machine, and unplug the power cord from the AC power outlet.

- Turning the printer OFF erases any queued print data.

2 Open the platen glass cover.

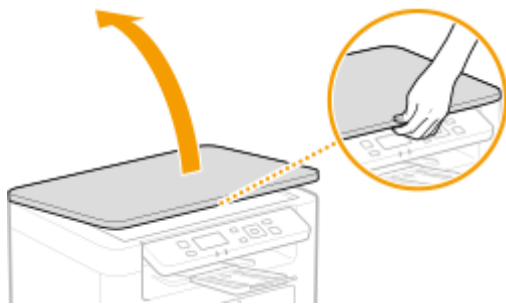

3 Clean the platen glass and the underside of the platen glass cover.

- Clean the areas with a cloth dampened with water. Then, wipe the area with a soft, dry cloth.

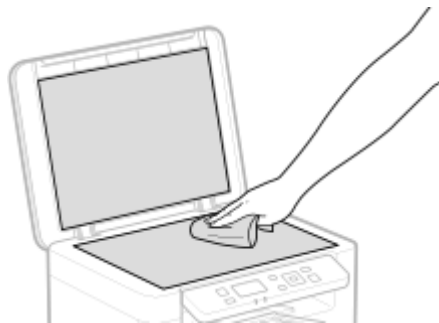

4 Wait for the cleaned area to dry completely.

5 Gently close the platen glass cover.

6 Reconnect the power cord and turn ON the machine.

Cleaning the Fixing Assembly

38CS-05F

Dirt may adhere to the fixing assembly inside the machine and cause black streaks to appear on printouts. To clean the fixing assembly, perform the following procedure. Note that you cannot clean the fixing assembly when the machine has documents waiting to be printed. To clean the fixing assembly, you need plain A4 or Letter size paper. Set the paper in the drawer before performing the following procedure. [▶ Loading Paper\(P. 86\)](#)

NOTE

- Cleaning consumes the toner cartridge and the drum cartridge. Make sure that there is sufficient amount remaining in the toner cartridge and the drum cartridge beforehand. [▶ Checking the Remaining Amount of Consumables\(P. 262\)](#)

- 1** Select **<Menu>** in the Home screen. [▶ Home Screen\(P. 78\)](#)
- 2** Select **<Adjustment/Maintenance>**.
- 3** Select **<Clean Fixing Assembly>**.
- 4** Check that the size and type of paper displayed on the screen is loaded in the machine, and select **<Start>**.
▢ Cleaning starts.

Replacing the Toner Cartridge

38CS-05H

The machine displays a message when the amount remaining in the toner cartridge is low. Note that the print quality may suffer if you continue printing without resolving this issue. You can check the amount remaining in the toner cartridges on the display ([▶Checking the Remaining Amount of Consumables\(P. 262\)](#)).

- ▶[When a Message Appear\(P. 255\)](#)
- ▶[Procedure for Replacing the Toner Cartridge\(P. 256\)](#)

When a Message Appear

The message that is displayed depends on the amount remaining in the toner cartridges. Depending on which message is displayed, prepare a new toner cartridge ([▶Consumables\(P. 268\)](#)) or replace the current toner cartridge with a new one ([▶Procedure for Replacing the Toner Cartridge\(P. 256\)](#)).

<Preparing a toner cart. is recommended.>

This message notifies you that the toner cartridge needs to be replaced soon. Make sure that you have a replacement toner cartridge ready. Replace the toner cartridge if you see this message before you start to print a large job.

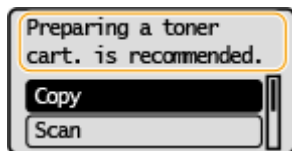

NOTE

When this message is displayed

- When copying or printing, you can continue printing the original.

<Toner cart. reached end of lifetime.>

This message notifies you that the toner cartridge has reached the end of its lifetime. Replace the toner cartridge with a new one.

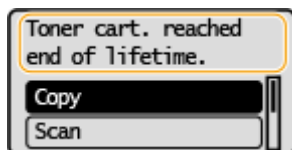

Select <Status Monitor> in the Home screen ▶ <Error Information/Notification> ▶ <Toner Cartridge End of Lifetime> to display the procedure for replacing the toner cartridge.

NOTE

To replace a consumable

- Press and hold the [Reset] key. On the <Output Report> screen, print the consumables status report to find out the cartridge name. [▶Printing Reports and Lists\(P. 266\)](#)

Procedure for Replacing the Toner Cartridge

When you replace the toner cartridge, simple instructions on the replacement procedure are displayed on the screen. See the on-screen instructions as well as the following procedure.

- 1 Lift the operation panel, close the paper stopper, and then open the toner cover.**

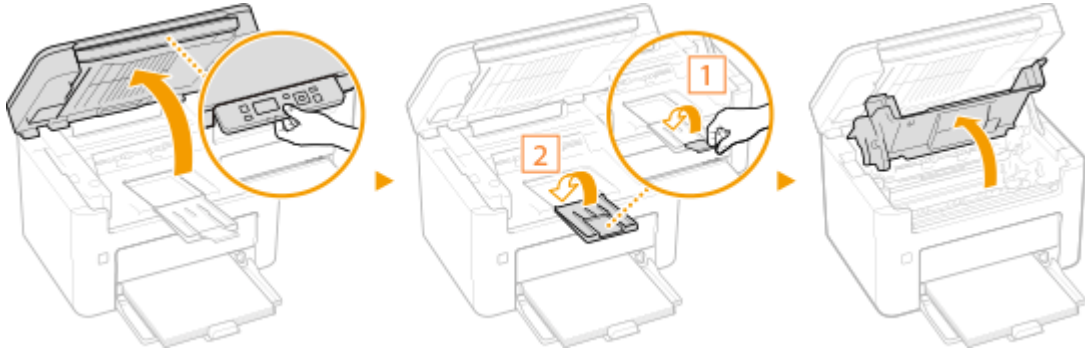

- 2 Pull the toner handles.**

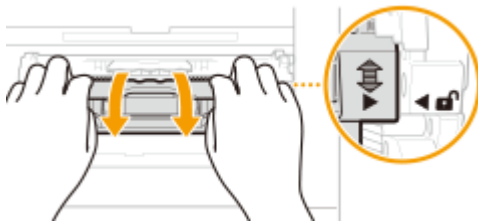

- 3 Remove the toner cartridge.**

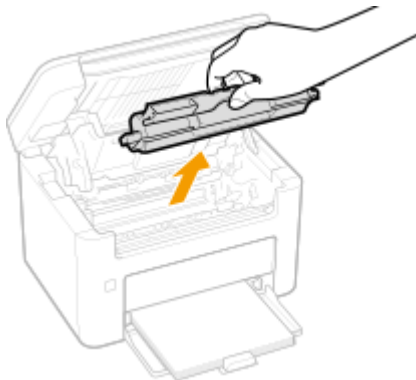

IMPORTANT:

Do not shake or tilt the toner cartridge. Also, make sure to avoid applying shocks to the toner cartridge, such as by hitting it against something. Doing so may cause the toner left in the toner cartridge to leak. Remove the toner cartridge gently at the same angle as the slot.

- 4 Remove the new toner cartridge from the protective package.**

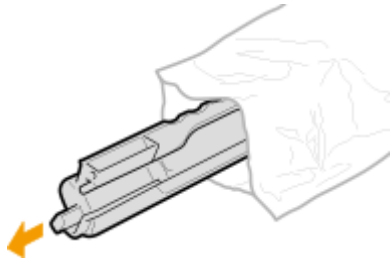

5 Shake the toner cartridge 5 or 6 times as shown below to evenly distribute the toner inside the cartridge, and then place it on a flat surface.

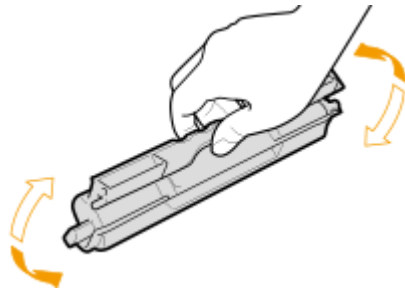

6 Replace the toner cartridge.

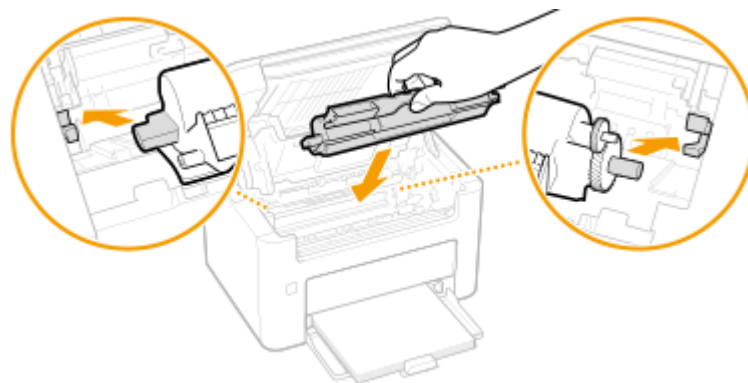

7 Push back the toner handles.



8 Close the toner cover, and lower the operation panel.

[LINKS](#)

◉ Consumables(P. 268)

Replacing the Drum Cartridge

38CS-05J

The machine displays a message when the amount remaining in the drum cartridge is low. Note that the print quality may suffer if you continue printing without resolving this issue. You can check the amount remaining in the drum cartridges on the display ([▶Checking the Remaining Amount of Consumables\(P. 262\)](#)).

- ▶[When a Message Appear\(P. 258\)](#)
- ▶[When Printouts are Poor in Quality\(P. 259\)](#)
- ▶[Procedure for Replacing the Drum Cartridge\(P. 259\)](#)

When a Message Appear

The message that is displayed depends on the amount remaining in the drum cartridges. Depending on which message is displayed, prepare a new drum cartridge ([▶Consumables\(P. 268\)](#)) or replace the current drum cartridge with a new one ([▶Procedure for Replacing the Drum Cartridge\(P. 259\)](#)).

<Preparing a drum cart. is recommended.>

This message notifies you that the drum cartridge needs to be replaced soon. Make sure that you have a replacement drum cartridge ready. Replace the drum cartridge if you see this message before you start to print a large job.

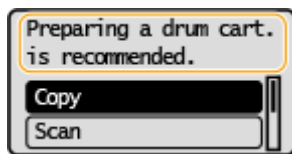

NOTE

When this message is displayed

- When copying or printing, you can continue printing the original.

Specify when this message is displayed

- You can set any value as the percentage of the amount remaining in the drum cartridge that triggers this message. [▶<Displ. Timing for Cartridge Prep. Notif.>\(P. 236\)](#)

When replacing the drum cartridge

- Note that the toner cartridge supplied with the replacement drum cartridge has a short lifetime since its purpose is simply to activate the replacement drum cartridge. Therefore, it is recommended to purchase a new toner cartridge, and have it ready for replacement.
- When replacing the drum cartridge, make sure to replace the toner cartridge as well, and avoid reusing the toner cartridge.

<Drum cart. reached end of lifetime.>

This message notifies you that the drum cartridge has reached the end of its lifetime. Replace the drum cartridge with a new one.

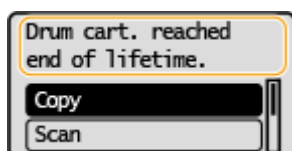

Select <Status Monitor> in the Home screen ► <Error Information/Notification> ► <Drum Cartridge End of Lifetime> to display the procedure for replacing the drum cartridge.

NOTE

When replacing the drum cartridge

- Note that the toner cartridge supplied with the replacement drum cartridge has a short lifetime since its purpose is simply to activate the replacement drum cartridge. Therefore, it is recommended to purchase a new toner cartridge, and have it ready for replacement.
- When replacing the drum cartridge, make sure to replace the toner cartridge as well, and avoid reusing the toner cartridge.

To replace a consumable

- Press and hold the [Reset] key. On the <Output Report> screen, print the consumables status report to find out the cartridge name. ► **Printing Reports and Lists(P. 266)**

When Printouts are Poor in Quality

If your printouts begin to show any of the following features, your drum cartridge is consumed. Replace the nearly empty drum cartridge even if no message is displayed. ► **Procedure for Replacing the Drum Cartridge(P. 259)**

Streaks Appear/Printing is Uneven



Partially faded



Uneven density



White Spots Appear



Toner smudges and splatters appear



Blank space of originals becomes grayish in printouts



Afterimages Appear in Blank Areas



Procedure for Replacing the Drum Cartridge

When you replace the drum cartridge, simple instructions on the replacement procedure are displayed on the screen. See the on-screen instructions as well as the following procedure.

- 1 Lift the operation panel, close the paper stopper, and then open the toner cover.**

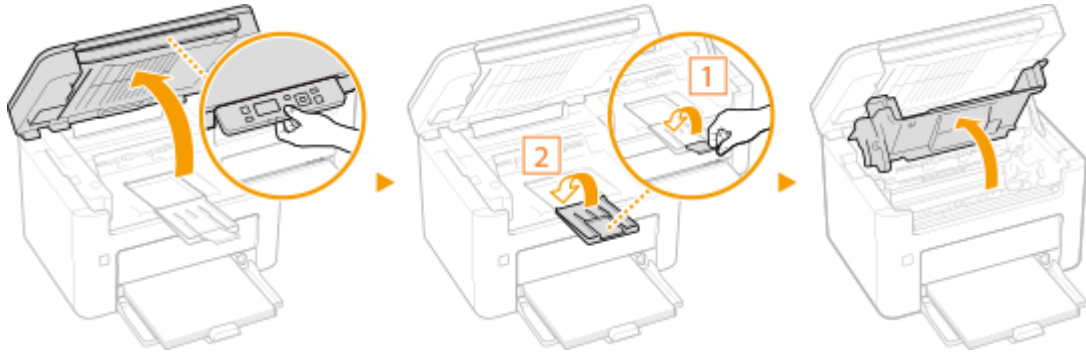

2 Remove the drum cartridge.

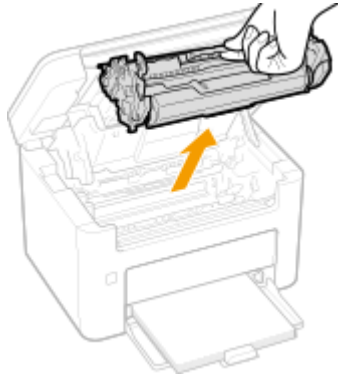

IMPORTANT:

Do not shake or tilt the drum cartridge. Also, make sure to avoid applying shocks to the drum cartridge, such as by hitting it against something. Doing so may cause the toner left in the drum cartridge to leak. Remove the drum cartridge gently at the same angle as the slot.

3 Remove the new drum cartridge from the protective bag.

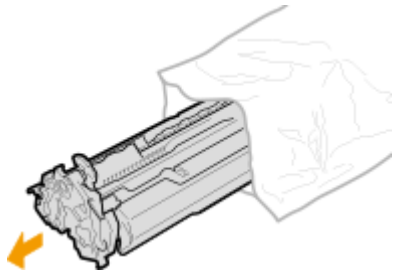

4 Shake the drum cartridge 5 or 6 times as shown below to evenly distribute the toner inside the drum cartridge, and then place it on a flat surface.

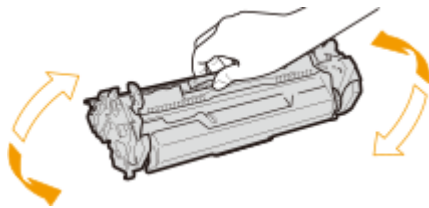

5 Replace the drum cartridge.

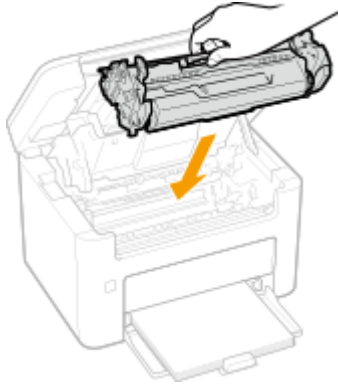

6 Close the toner cover, and lower the operation panel.

LINKS

▶ [Consumables\(P. 268\)](#)

Checking the Remaining Amount of Consumables

38CS-05K

Use the procedure below to check the amount remaining in the toner cartridges, etc. It is particularly important to check whether you need to have a new toner cartridge or a new drum cartridge ready before starting a large print job.

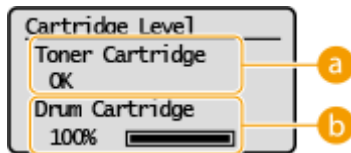

a Amount Remaining in Toner Cartridge

Displays the amount remaining in the toner cartridges.

b Amount Remaining in Drum Cartridge

Displays the amount remaining in the drum cartridges.

NOTE

- The displayed amount remaining in the toner cartridge or the drum cartridge can be used only as a guide and may differ from the actual amount.
- Other internal parts may reach the end of their lifetime before the amount remaining in the toner cartridge or the drum cartridge reaches its lifetime.

LINKS

- ▶ [Replacing the Toner Cartridge\(P. 255\)](#)
- ▶ [Replacing the Drum Cartridge\(P. 258\)](#)
- ▶ [Consumables\(P. 268\)](#)

Relocating the Machine

The machine is heavy. Make sure to follow the procedure below when moving the machine to avoid injury.

1 Turn OFF the machine and computer.

- When you turn OFF the machine, data that is waiting to be printed is deleted.

2 Disconnect the cables and cord from the machine in numerical order as in the illustration below.

- Whether the cables with "*" are connected depends on your environment.

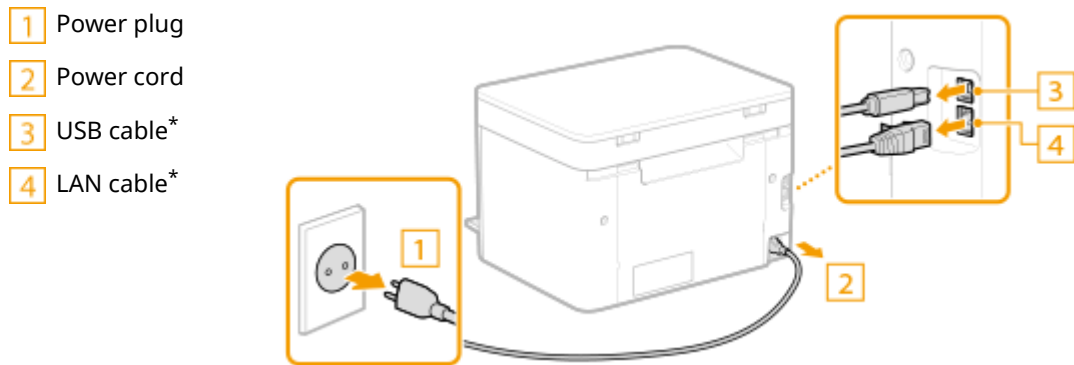

3 When transporting the machine across a long distance, remove the drum cartridge.

▶ Procedure for Replacing the Drum Cartridge(P. 259)

4 Remove the paper cover and any paper.

- If the paper guides are extended, return them so that they fit in the drawer.

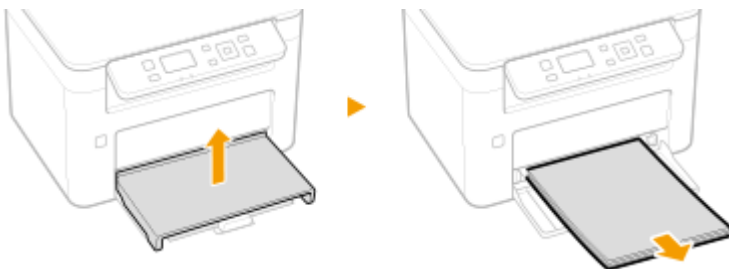

5 Close the drawer, paper stopper, and all similar parts, and then move the machine to a new location.

- Check how heavy the machine is and carry it without straining. ▶ Main Unit(P. 322)

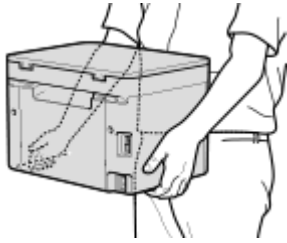

6 Carefully place the machine at the new installation site.

- For information about how to install the machine after relocating it, see "Getting Started." **▶ Manuals and Their Contents(P. 332)**

Viewing the Counter Value

38CS-05R

You can check total for the number of pages used for printouts. This total include reports and lists, in addition to copies and printouts of data from computers.

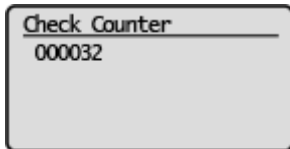
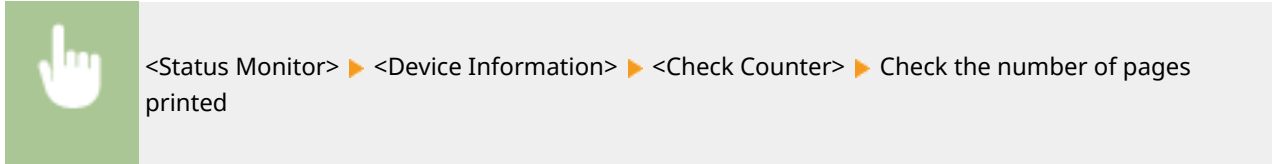

Printing Reports and Lists

You can print reports and lists to check information such as machine settings.

- ▶ **Printing Lists of Settings(P. 266)**
- ▶ **Printing Reports on the Usage Status of the Machine(P. 266)**

Printing Lists of Settings

You can print information and settings registered in the machine as a list.

User Data List

You can check the list of the settings (▶ **Setting Menu List(P. 213)**) as well as the content that has been registered in the machine by printing a User Data List.



<Menu> ▶ <Output Reports> ▶ <User Data List> ▶ Check that the size and type of paper displayed on the screen is loaded in the machine ▶ <OK> ▶ <Yes>

Printing Reports on the Usage Status of the Machine

You can print the following machine status reports.

Eco Report

You can check the monthly total volume of printouts and the power consumption with a report. This report includes tips that are useful for saving paper and power consumption based on the usage status.



<Menu> ▶ <Output Reports> ▶ <Eco Report> ▶ Check that the size and type of paper displayed on the screen is loaded in the machine ▶ <OK> ▶ <Yes>

NOTE

- The amount of power consumption may vary depending on the environment and conditions where the machine is used.

Consumables Status Report

You can check the consumables status installed in the machine with a report.



<Menu> ▶ <Output Reports> ▶ <Consumables Status Report> ▶ Check that the size and type of paper displayed on the screen is loaded in the machine ▶ <OK> ▶ <Yes>

Consumables

38CS-05U

The following is a guide to the estimated replacement time for the consumables used in this machine. Purchase consumables at your local authorized Canon dealer. Observe safety and health precautions when storing and handling consumables. For optimum print quality, using Canon genuine Toner, Cartridge and Parts is recommended.



NOTE

- To handle and store consumables, observe precautions in "Getting Started" provided for this product.
- Depending on the installation environment, printing paper size, or original type, you may need to replace consumables before the end of the estimated lifetime.

■ Toner Cartridges

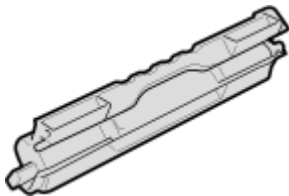

Supplied Toner Cartridges

The average yield and the weight of the toner cartridges that come with the machine are shown below.

- Average yield*
2,500 sheets
- Weight
Approx. 0.2 kg

Replacement Toner Cartridges

For optimum print quality, using Canon genuine toner cartridges is recommended.

Canon Genuine Toner Cartridge	Average yield and weight of toner cartridge
Canon Toner Cartridge 050	<ul style="list-style-type: none"> • Average yield* 2,500 sheets • Weight Approx. 0.2 kg

*The average yield is based on "ISO/IEC 19752" (the global standard related to "Method for the determination of toner cartridge yield for monochromatic electrophotographic printers and multi-function devices that contain printer components" issued by ISO [International Organization for Standardization]) when printing A4 size paper with the default print density setting.

IMPORTANT

Be careful of counterfeit toner cartridges

- Please be aware that there are counterfeit Canon toner cartridges in the marketplace. Use of counterfeit toner cartridge may result in poor print quality or machine performance. Canon is not responsible for any malfunction, accident or damage caused by the use of counterfeit toner cartridge. For more information, see canon.com/counterfeit.

NOTE

- When replacing toner cartridges, see **▶Replacing the Toner Cartridge(P. 255)** .

■ **Drum Cartridges**

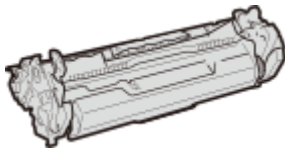

Supplied Drum Cartridge

The average yield and the weight of the drum cartridge that comes with the machine are shown below.

- Average yield*
10,000 sheets
- Weight
Approx. 0.6 kg

Replacement Drum Cartridges

For optimum print quality, using Canon genuine drum cartridges is recommended.

Canon Genuine Drum Cartridge	Average yield and weight of drum cartridge
Canon Drum Cartridge 050	<ul style="list-style-type: none"> • Average yield* 10,000 sheets • Weight Approx. 0.6 kg

*The average yield is estimated when printing under the following conditions.
Printing ratio: approx. 5%, Printing density: default setting, Paper size: A4, Paper type: Plain paper, 2-sheet to 3-sheet intermittent printing

IMPORTANT

Be careful of counterfeit drum cartridges

- Please be aware that there are counterfeit Canon drum cartridges in the marketplace. Use of counterfeit drum cartridge may result in poor print quality or machine performance. Canon is not responsible for any malfunction, accident or damage caused by the use of counterfeit drum cartridge. For more information, see canon.com/counterfeit.

NOTE

- Note that the toner cartridge supplied with the replacement drum cartridge has a short lifetime since its purpose is simply to activate the replacement drum cartridge. Therefore, it is recommended to purchase a new toner cartridge, and have it ready for replacement.
- When replacing drum cartridges, see [▶ Replacing the Drum Cartridge\(P. 258\)](#) .

Troubleshooting

Troubleshooting	272
Common Problems	274
Installation/Settings Problems	275
Copying/Printing Problems	279
When You Cannot Print Properly	282
Printing Results Are Not Satisfactory	284
Paper Creases or Curls	292
Paper Is Fed Incorrectly	294
A Message or a Number Starting with "#" (an Error Code) Is Displayed	295
Countermeasures for Each Message	296
Countermeasures for Each Error Code	305
Clearing Paper Jams	306
Paper Jams inside the Machine	307
When a Problem Cannot Be Solved	310

Troubleshooting

38CS-05W

When a problem occurs, check this chapter to find out solutions before contacting Canon.

■ Common Problems

This section describes how to take action when you suspect that the machine is malfunctioning. ▶ **Common Problems(P. 274)**



■ When You Cannot Print Properly

This section describes how to take action when printing results are not satisfactory or the paper creases or curls. ▶ **When You Cannot Print Properly(P. 282)**



■ A Message or a Number Starting with "#" (an Error Code) is Displayed

This section describes how to take action when a message or error code (three digits) appears on the display. ▶ **A Message or a Number Starting with "#" (an Error Code) Is Displayed(P. 295)**



■ Clearing Paper Jams

This section describes how to take action when a paper is jammed. ▶ **Clearing Paper Jams(P. 306)**



■ When a Problem Cannot Be Solved

If a problem persists, see ▶ **When a Problem Cannot Be Solved(P. 310)** to find out where to contact.

Troubleshooting



Common Problems

38CS-05X

If you encounter problems when using the machine, check the items in this section before contacting us. If the problems persist, contact your local authorized Canon dealer or the Canon help line.

Check the Following

→ Is the machine turned ON? Is the power cord connected?

- If the machine is turned ON but does not respond, turn it OFF, check whether the power cord is connected correctly, and turn it back ON. For information on connecting the power cord, see Getting Started. ▶ **Manuals and Their Contents(P. 332)**

→ Is the machine connected via wireless LAN, a LAN cable, or a USB cable?

- Check whether the machine is connected correctly. When connecting the machine to a wireless LAN, check whether the Wi-Fi icon appears on the screen. If the Wi-Fi icon is not displayed, the machine is not connected to the wireless LAN.
 - ▶ **Parts and Their Functions(P. 67)**
 - ▶ **When the Machine Cannot Connect to the Wireless LAN(P. 276)**

→ Is sleep mode activated?

- If you leave the machine unattended for a specific period of time, it enters sleep mode for power conservation, not allowing you to operate it.
To cancel sleep mode, press any key other than the power switch.

→ Is any message displayed on the screen?

- If a problem occurs, a message is displayed. ▶ **Countermeasures for Each Message(P. 296)**

If a problem persists even after checking

Click the link that corresponds to the problem.

- ▶ **Installation/Settings Problems(P. 275)**
- ▶ **Copying/Printing Problems(P. 279)**

Installation/Settings Problems

38CS-05Y

See [▶Common Problems\(P. 274\)](#) also.

- ▶[Problems with the Wireless/Wired LAN Connection\(P. 275\)](#)
- ▶[Problem with the USB Connection\(P. 278\)](#)
- ▶[Problem with the Print Server\(P. 278\)](#)

Problems with the Wireless/Wired LAN Connection

The wireless LAN and wired LAN cannot be connected at the same time.

- The wireless LAN and wired LAN cannot be connected at the same time. The following can be used at the same time: a USB cable and a wireless LAN, or a USB cable and a wired LAN.

Remote UI is not displayed.

- Are <Use HTTP> and <Use Remote UI> set to <On>?
 - ▶[Disabling HTTP Communication\(P. 195\)](#)
 - ▶[Disabling Remote UI\(P. 196\)](#)
- If the machine is connected to a wireless LAN, check that the Wi-Fi icon is displayed in the Home screen and that the IP address is set correctly, and then start the Remote UI again.
 - ▶[Home Screen\(P. 78\)](#)
 - ▶[Viewing Network Settings\(P. 34\)](#)
- If the machine is connected to a wired LAN, check that the cable is connected firmly and the IP address is set correctly, and then start the Remote UI again.
 - ▶[Connecting to a Wired LAN\(P. 14\)](#)
 - ▶[Viewing Network Settings\(P. 34\)](#)
- Are you using a proxy server? If so, add the machine's IP address to the [Exceptions] list (addresses that do not use the proxy server) in the Web browser's proxy settings dialog.
- Is communication not limited by the firewall on your computer? If IP addresses are or an MAC address is incorrectly entered, the Remote UI cannot be displayed. In that case, you need to use the operation panel to set <IPv4 Address Filter>, <IPv6 Address Filter>, or <MAC Address Filter> to <Off>.
 - ▶[Restricting Communication by Using Firewalls\(P. 170\)](#)
 - ▶[<IPv4 Address Filter>\(P. 242\)](#)
 - ▶[<IPv6 Address Filter>\(P. 242\)](#)
 - ▶[<MAC Address Filter>\(P. 243\)](#)

A connection to a network cannot be established.

- The IP address may not be set correctly. Set the IP address again.
 - ▶[Setting IP Addresses\(P. 27\)](#)
- When you connect the machine to a computer via wireless LAN, check whether the machine is properly installed and ready to connect to the network.
 - ▶[When the Machine Cannot Connect to the Wireless LAN\(P. 276\)](#)

You are unsure of the set IP address. ▶ Viewing Network Settings(P. 34)

The connection method cannot be switched between a wired LAN and a wireless LAN.

- Did you select a wired LAN or a wireless LAN on the operation panel on the machine as well? This selection is required to have the machine switch to your selection.
▶ **Selecting Wired LAN or Wireless LAN(P. 13)**

You are unsure of the SSID or the network key of the wireless router to be connected. The SSID is not displayed on the screen.

- Check whether the SSID can be found on the wireless router or package box.
- Check the SSID or the network key of the wireless router by using Canon MF/LBP Wireless Setup Assistant.
▶ **Checking the SSID and Network Key(P. 26)**

The SSID of the wireless router to be connected is not displayed in the access point list.

- Check whether the SSID is correct.
▶ **Checking the SSID and Network Key(P. 26)**
- If the SSID of the wireless router is hidden (using a stealth mode*), set the SSID to be visible on the wireless router.

* A mode that disables the SSID auto-detection of other devices.

- Check whether the machine is properly installed and ready to connect to the network.
▶ **When the Machine Cannot Connect to the Wireless LAN(P. 276)**

The machine dials up to an unintended connection destination (if a dialup router is connected to a network).

- If a dialup router does not need to pass broadcast packets, set the dialup router so that the broadcast packets will not pass. If the dialup router needs to pass broadcast packets, check whether the settings are correct.
- If a DNS server is located in an external network, set the IP address to be connected, not the host name, even if connecting to the devices that are on the network that is connected to the machine.
- If a DNS server is located on a network that is connected to the machine and the information about the devices that are connected to an external network is registered to the DNS server, check whether the settings are correct.

When the Machine Cannot Connect to the Wireless LAN



1 Check the status of your computer.

- Have the settings of the computer and the wireless router been completed?
- Are the cables of the wireless router (including the power cord and LAN cable) correctly plugged in?
- Is the wireless router turned on?

If the problem persists even after checking the above:

- Turn off the devices, and then turn them on again.
- Wait for a while, and try again to connect to the network.



Check whether the machine is turned ON.

- If the machine is turned ON, turn it OFF, and then turn it back ON.



Check the installation site of the machine and the wireless router.

- Is the machine too far from the wireless router?
- Are there any obstacles such as walls between the machine and the wireless router?
- Are there any appliances such as microwave ovens or digital cordless phones that emit radio waves near the machine?

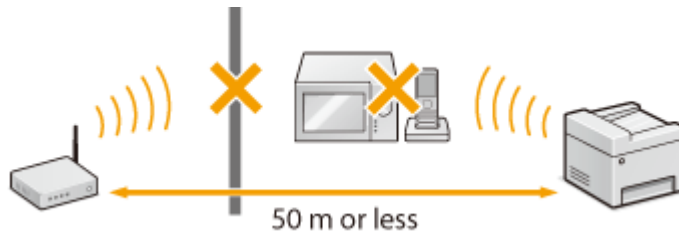

Perform one of the following settings again.

- ▶ **Setting Up Connection Using WPS Push Button Mode(P. 17)**
- ▶ **Setting Up Connection Using WPS PIN Code Mode(P. 19)**
- ▶ **Setting Up Connection by Selecting a Wireless Router(P. 21)**
- ▶ **Setting Up Connection by Specifying Detailed Settings(P. 23)**

NOTE

When you need to manually set up the connection

If the wireless router is set as described below, manually enter all the required information for the wireless LAN connection (▶ **Setting Up Connection by Specifying Detailed Settings(P. 23)**).

- ANY connection refusal* is activated.
- The WEP key that was automatically generated (hexadecimal) is selected.
- The stealth mode is activated.

* A function in which the wireless router refuses the connection if the SSID on the device to be connected is set to "ANY" or is blank.

When you need to change the settings of the wireless router

If the wireless router is set as described below, change the settings of the router.

- The MAC address packet filtering is set.

- When only IEEE 802.11n is used for the wireless communication, WEP is selected or the WPA/WPA2 encryption method is set to TKIP.

Problem with the USB Connection

Cannot communicate.

- Change the USB cable. If you are using a long USB cable, replace it with a short one.
- If you are using a USB hub, connect the machine directly to your computer using a USB cable.

Problem with the Print Server

You cannot find the print server to connect to.

- Are the print server and computer connected correctly?
- Is the print server running?
- Do you have user rights to connect to the print server? If you are not sure, contact the server administrator.
- Is [Network discovery] enabled?
 - ▶ **Enabling [Network discovery](P. 338)**

You cannot connect to a shared printer.

- On the network, does the machine appear among the printers of the print server? If it is not displayed, contact the network or server administrator.
 - ▶ **Displaying Shared Printers in the Print Server(P. 339)**

Copying/Printing Problems

38CS-060

See [▶Common Problems\(P. 274\)](#) also.

Printing/copy results are not satisfactory. Paper creases or curls. [▶When You Cannot Print Properly\(P. 282\)](#)

You cannot print.

- Can you print a Windows test page? If you can print a Windows test page, there is no problem with the machine or the printer driver. Check the print settings of your application.

[▶Printing a Test Page in Windows\(P. 340\)](#)

If you cannot print a test page, check the following according to your environment.

■ Wireless LAN connection

- Check the connection status (signal strength) of the wireless LAN.

[▶Viewing Network Settings\(P. 34\)](#)

NOTE:

- If the connection is poor, try the following.
 - Change the channel of your wireless LAN router. If you have more than one router, set the channels to be at least five channels apart.
 - If you can change the radio output power of your wireless LAN router, raise the output power.
- If your computer is connected to a wireless LAN, are the computer and this machine using the same wireless LAN router SSID? If they are different, reset the wireless LAN connection settings of this machine.
 - [▶Viewing Network Settings\(P. 34\)](#)
 - [▶Checking the SSID to Which Your Computer is Connected\(P. 344\)](#)
 - [▶Connecting to a Wireless LAN\(P. 15\)](#)

NOTE:

When you reset wireless LAN connection settings

- As the wireless LAN router, select the one with the SSID to which the computer is connected.
 - Have you selected the correct port? If there is no port to use, create a port.
 - [▶Checking the Printer Port\(P. 342\)](#)
 - [▶Configuring Printer Ports\(P. 39\)](#)
 - Is communication not limited by the firewall on your computer? If IP addresses are incorrectly entered, you will be not able to access the machine. In that case, you need to use the operation panel to set <IPv4 Address Filter> or <IPv6 Address Filter> to <Off>.
 - [▶Restricting Communication by Using Firewalls\(P. 170\)](#)
 - [▶<IPv4 Address Filter> \(P. 242\)](#)
 - [▶<IPv6 Address Filter> \(P. 242\)](#)
 - Disable security software and other resident software.
 - Reinstall the printer driver.
 - [▶Installing Drivers\(P. 60\)](#)

- Can you print from other computers on the network? If you also cannot print from other computers, contact your local authorized Canon dealer or the Canon help line.

■ **Wired LAN connection**

- Have you selected the correct port? If there is no port to use, create a port.
 - ▶ **Checking the Printer Port(P. 342)**
 - ▶ **Configuring Printer Ports(P. 39)**
- Is communication not limited by the firewall on your computer? If IP addresses are or an MAC address is incorrectly entered, you will be not able to access the machine. In that case, you need to use the operation panel to set <IPv4 Address Filter>, <IPv6 Address Filter>, or <MAC Address Filter> to <Off>.
 - ▶ **Restricting Communication by Using Firewalls(P. 170)**
 - ▶ **<IPv4 Address Filter>(P. 242)**
 - ▶ **<IPv6 Address Filter>(P. 242)**
 - ▶ **<MAC Address Filter>(P. 243)**
- Disable security software and other resident software.
- Reinstall the printer driver.
 - ▶ **Installing Drivers(P. 60)**
- Can you print from other computers on the network? If you also cannot print from other computers, contact your local authorized Canon dealer or the Canon help line.

■ **USB connection**

- Have you selected the correct port? If there is no port to use or you are not sure, reinstall the printer driver. When you reinstall the printer driver, the correct port is created automatically.
 - ▶ **Checking the Printer Port(P. 342)**
 - ▶ **Installing Drivers(P. 60)**
- Is bidirectional communication enabled? Enable bidirectional communication, and restart the computer.
 - ▶ **Checking Bidirectional Communication(P. 343)**
- Disable security software and other resident software.
- Connect to another USB port on the computer.
- Can you print from a USB connection to another computer? If you also cannot print from other computers, contact your local authorized Canon dealer or the Canon help line.

■ **Via print server**

- Can you print from the print server? If you can print from the print server, check the connection between the print server and your computer.
 - ▶ **Problem with the Print Server(P. 278)**
- Disable security software and other resident software.
- Reinstall the printer driver.
 - ▶ **Installing Drivers(P. 60)**
- Can you print from other computers via the print server? If you also cannot print from other computers, contact your local authorized Canon dealer or the Canon help line.

- Has an error occurred? Check the job log.
 - ▶ **Checking the Copying Status(P. 109)**
 - ▶ **Checking the Printing Status and Log(P. 123)**

Printing seems to be slow.*

- Print or delete data in memory.

* When the free space in memory is running low, the processing speed of the machine becomes slow, just as a computer does. There is nothing abnormal.

You cannot print with Google Cloud Print. Using Google Cloud Print(P. 157)

It takes a long time before printing starts.

- Did you print to narrow width paper? After you print to narrow width paper, the machine may cool itself to maintain the print quality. As a result, it may take some time before the next job is printed. Wait until the machine is ready to print. Printing will resume when the temperature inside the machine has fallen.

When You Cannot Print Properly

38CS-061

If printing results are not satisfactory, or paper creases or curls, try the following solutions. If the problems persist, contact your local authorized Canon dealer or the Canon help line.

■ Problems with Image Quality ▶ Printing Results Are Not Satisfactory(P. 284)

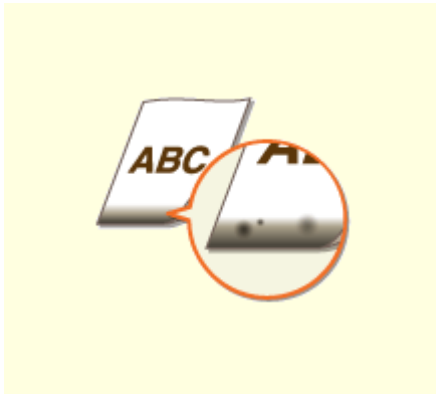

▶ Smudge Marks Appear on the Edge of Printouts(P. 284)



▶ Smudges Appear on Printouts(P. 284)



▶ Afterimages Appear in Blank Areas(P. 285)



▶ Toner Smudges and Splatters Appear(P. 285)



▶ Printouts Are Faded(P. 286)



▶ A Portion of the Page Is Not Printed(P. 287)



▶ Streaks Appear/Printing is Uneven(P. 288)

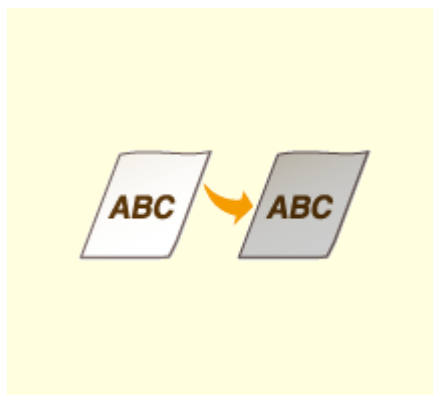

▶ Printouts Are Entirely or Partially Grayish(P. 289)



▶ White Spots Appear(P. 290)



▶ Spots Appear(P. 290)



▶ Reverse Side of Paper is Smudged(P. 291)



▶ Printed Barcode Cannot Be Read(P. 291)

■ Problems with Printout Paper ▶ Paper Creases or Curls(P. 292)



▶ Paper Creases(P. 292)



▶ Paper Curls(P. 292)

■ Problems with Paper Feed ▶ Paper Is Fed Incorrectly(P. 294)

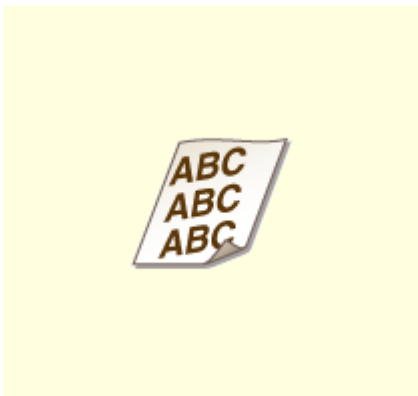

▶ Printouts Are Skewed(P. 294)



▶ Paper Is Not Fed/Two or More Sheets Are Fed Together(P. 294)

Printing Results Are Not Satisfactory

38CS-062

Dirt inside the machine may affect printing results. Perform care and cleaning to the machine first. **▶Regular Cleaning(P. 251)**

Smudge Marks Appear on the Edge of Printouts

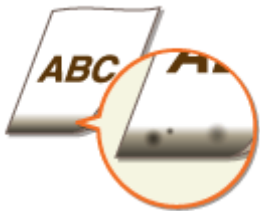

→ Are you using appropriate paper?

- Check the supported paper types and replace with an appropriate type. Also, set the paper size and type correctly.
 - ▶ **Available Paper(P. 325)**
 - ▶ **Loading Paper(P. 86)**
 - ▶ **Specifying Paper Size and Type(P. 95)**

→ Do you print data without margins?

- This symptom occurs if a margin is set to none in the printer driver. A margin of 5 mm or less around the edge of paper or 10 mm or less around the edge of envelopes is not printable with the machine. Make sure to have margins around the document to print.

[Finishing] tab ▶ [Advanced Settings] ▶ [Expand Print Region and Print] ▶ [Off]

Smudges Appear on Printouts



→ Are you using appropriate paper?

- Check usable paper, and replace with appropriate paper.
 - ▶ **Available Paper(P. 325)**
 - ▶ **Loading Paper(P. 86)**
- If using the appropriate paper still does not solve the problem, changing the <Special Printing Mode A> or <Special Printing Mode Z> setting may solve the problem. <Mode 2> can improve the quality more significantly than <Mode 1>.

▶<Special Processing>(P. 236)

Afterimages Appear in Blank Areas



→ Are you using appropriate paper?

- Check usable paper, and replace with appropriate paper.
 - ▶<Available Paper>(P. 325)
 - ▶<Loading Paper>(P. 86)

→ Is the amount remaining in the drum cartridge running low?

- Check how much the amount remaining in the drum cartridge is left, and replace the drum cartridge as necessary.
- Regardless of the amount remaining in the drum cartridge, the drum cartridge may reach the end of its lifetime depending on the use environment or the deterioration of materials inside the drum cartridge.
 - ▶<Replacing the Drum Cartridge>(P. 258)

Toner Smudges and Splatters Appear



→ Are you using appropriate paper?

- Check usable paper, and replace with appropriate paper.
 - ▶<Available Paper>(P. 325)
 - ▶<Loading Paper>(P. 86)
- Setting <Special Printing Mode U> to <On> may solve the problem.
 - ▶<Special Processing>(P. 236)

→ Are you using paper containing much paper dust or other dust particles?

- Smudges may appear in a printout when the paper has a lot of paper dust or other dust particles. Setting <Special Printing Mode L> to <On> may solve the problem.
 - ▶<Special Processing>(P. 236)

→ Is the amount remaining in the drum cartridge running low?

- Check how much the amount remaining in the drum cartridge is left, and replace the drum cartridge as necessary.
- Regardless of the amount remaining in the drum cartridge, the drum cartridge may reach the end of its lifetime depending on the use environment or the deterioration of materials inside the drum cartridge.
 - ▶ **Replacing the Drum Cartridge(P. 258)**

Printouts Are Faded



→ Are you using appropriate paper?

- Check usable paper, and replace with appropriate paper. Also, specify the paper size and type settings properly.
 - ▶ **Available Paper(P. 325)**
 - ▶ **Loading Paper(P. 86)**
 - ▶ **Specifying Paper Size and Type(P. 95)**

→ Are you using paper containing much paper dust?

- Using paper containing much paper dust may result in a faded or streaky printout. Setting <Special Printing Mode G> to <On> may solve the problem.
 - ▶ **<Special Processing>(P. 236)**

→ Are you using rough-surface paper?

- Printed images may be faint when they are printed on rough-surface paper. Setting <Special Printing Mode Q> to <On> may solve the problem.
 - ▶ **<Special Processing>(P. 236)**

NOTE:

- Setting this to <On> may affect the image quality.

→ Are you using the machine in an environment with high humidity?

- Setting <Special Printing Mode T> to <On> may solve the problem.
 - ▶ **<Special Processing>(P. 236)**

NOTE:

- Printed images or text may be blurred when you set this to <On> and print in a low-humidity environment.

→ Did you print on the back of a printed sheet?

- Printing may be faint when you print on the back of a printed sheet. Setting <Special Printing Mode R> to <On> may solve the problem.
 ▶<Special Processing>(P. 236)

NOTE:

- If you set to <On>, image quality may be affected or a paper jam may occur when a certain length of time elapses after printing on the front side or depending on the ambient humidity.

→ Is the machine installed in the appropriate environment?

- Install the printer in an appropriate location.

→ Is the amount remaining in the drum cartridge running low?

- Check how much the amount remaining in the drum cartridge is left, and replace the drum cartridge as necessary.
- Regardless of the amount remaining in the drum cartridge, the drum cartridge may reach the end of its lifetime depending on the use environment or the deterioration of materials inside the drum cartridge.
 ▶<Replacing the Drum Cartridge>(P. 258)

A Portion of the Page Is Not Printed

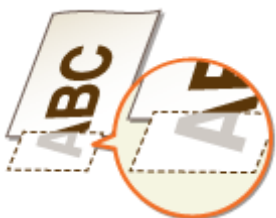

→ Do you print data without margins?

- This symptom occurs if a margin is set to none in the printer driver. A margin of 5 mm or less around the edge of paper or 10 mm or less around the edge of envelopes is not printable with the machine. Make sure to have margins around the document to print.

[Finishing] tab ▶ [Advanced Settings] ▶ [Expand Print Region and Print] ▶ [Off]

→ Do the paper guides align with the edges of the paper?

- If the paper guides are too loose or too tight, part of a document may not be printed.
 ▶<Loading Paper>(P. 86)

Streaks Appear/Printing is Uneven



→ Are you using appropriate paper?

- Check usable paper, and replace with appropriate paper.
 - ▶ **Available Paper(P. 325)**
 - ▶ **Loading Paper(P. 86)**

→ Is the platen glass dirty?

- Clean the platen glass.
 - ▶ **Cleaning the Platen Glass(P. 253)**

→ Have you cleaned the fixing unit?

- Clean the fixing unit.
 - ▶ **Cleaning the Fixing Assembly(P. 254)**

→ Are you using rough-surface paper?

- Printed images may be faint when they are printed on rough-surface paper. Setting <Special Printing Mode Q> to <On> may solve the problem.
 - ▶ **<Special Processing>(P. 236)**

NOTE:

- Setting this to <On> may affect the image quality.

→ Are you using the machine in an environment with high humidity?

- Change the setting for <Special Printing Mode T>. Setting this item to <On> may solve the problem.
 - ▶ **<Special Processing>(P. 236)**

NOTE:

- Printed images or text may be blurred when you set this to <On> and print in a low-humidity environment.

→ Are you using paper containing much paper dust?

- Using paper containing much paper dust may result in a faded or streaky printout. Setting <Special Printing Mode G> to <On> may solve the problem.
 - ▶ **<Special Processing>(P. 236)**

→ **Is the amount remaining in the drum cartridge running low?**

- Check how much the amount remaining in the drum cartridge is left, and replace the drum cartridge as necessary.
- Regardless of the amount remaining in the drum cartridge, the drum cartridge may reach the end of its lifetime depending on the use environment or the deterioration of materials inside the drum cartridge.
 - ▶ **Replacing the Drum Cartridge(P. 258)**

Printouts Are Entirely or Partially Grayish



→ **Is <Correct Density> in <Copy Settings> set too dark?**

- Adjust the setting so that density is lighter.
 - ▶ **<Correct Density>(P. 232)**

→ **Does the original have background color, is it stained, or are you copying an original such as a newspaper that is printed on thin paper so that text or images on the other side are visible through the paper?**

- Check the original and then adjust the density to the correct settings.
 - ▶ **Basic Copy Operations(P. 105)**

→ **Are you using a specific type of paper?**

- The printed side may come out in grayish color for certain type of paper. Check the type of paper you are using and try a different type.
 - ▶ **Available Paper(P. 325)**
- Setting <Special Printing Mode U> or <Special Printing Mode G> to <On> may solve the problem.
 - ▶ **<Special Processing>(P. 236)**

NOTE:

- A desirable effect may not be attained even with these settings applied.

→ **Is the machine installed in the appropriate environment?**

- Install the printer in an appropriate location.

→ **Has the drum cartridge been left in direct sunlight for a long period of time?**

- Store the drum cartridge in an appropriate location for two to three hours, then try printing again. This may solve the problem. If the problem persists, replace the drum cartridge.
 - ▶ **Replacing the Drum Cartridge(P. 258)**

White Spots Appear



→ **Are you using paper that has absorbed moisture?**

- Replace with appropriate paper.
 - ▶ **Loading Paper(P. 86)**

→ **Are you using appropriate paper?**

- Check usable paper, and replace with appropriate paper.
 - ▶ **Available Paper(P. 325)**
 - ▶ **Loading Paper(P. 86)**

→ **Is the amount remaining in the drum cartridge running low?**

- Check how much the amount remaining in the drum cartridge is left, and replace the drum cartridge as necessary.
- Regardless of the amount remaining in the drum cartridge, the drum cartridge may reach the end of its lifetime depending on the use environment or the deterioration of materials inside the drum cartridge.
 - ▶ **Replacing the Drum Cartridge(P. 258)**

Spots Appear



→ **Have you cleaned the fixing unit?**

- Clean the fixing unit.

▶ **Cleaning the Fixing Assembly(P. 254)**

Reverse Side of Paper is Smudged



➔ **Have you loaded paper that is smaller than the size of the print data?**

- Check to make sure that the paper size matches the size of the print data.

➔ **Have you cleaned the fixing unit?**

- Clean the fixing unit.
▶ **Cleaning the Fixing Assembly(P. 254)**

Printed Barcode Cannot Be Read



➔ **Are you trying to read a small barcode or one with thick lines?**

- Enlarge the barcode.
- Changing the <Select Line Width> setting may solve the problem.
▶ **<Special Processing>(P. 236)**

Paper Creases or Curls

38CS-063

Paper Creases



→ Is paper loaded correctly?

- If paper is not loaded below the load limit line or is loaded obliquely, it may crease.
 - ▶ **Loading Paper(P. 86)**

→ Are you using paper that has absorbed moisture?

- Replace with appropriate paper.
 - ▶ **Loading Paper(P. 86)**

→ Are you using appropriate paper?

- Check usable paper, and replace with appropriate paper.
 - ▶ **Available Paper(P. 325)**
 - ▶ **Loading Paper(P. 86)**

Paper Curls



→ Are you using appropriate paper?

- Check usable paper, and replace with appropriate paper. Also, specify the paper size and type settings properly.
 - ▶ **Available Paper(P. 325)**
 - ▶ **Loading Paper(P. 86)**
 - ▶ **Specifying Paper Size and Type(P. 95)**
- Change the setting of <Paper Type> to a setting for thinner paper. For example, if the current setting is <Plain (71-89 g/m²)>, change it to <Plain L (61-70 g/m²)> or <Plain L2 (60 g/m²)>.

▶ **Specifying Paper Size and Type(P. 95)**

▶ **Available Paper(P. 325)**

- Reload the paper by changing the side to print on (front side/back side).

IMPORTANT:

- In rare cases the symptom may become worse depending on the paper. If this occurs, change the side to print on back to the previous side.

→ Are you using paper that has absorbed moisture?

- Replace with appropriate paper.
 - ▶ **Loading Paper(P. 86)**

Paper Is Fed Incorrectly

38CS-064

Printouts Are Skewed



→ Do the paper guides align with the edges of the paper?

- If the paper guides are too loose or too tight, the printouts are skewed.
▶ **Loading Paper(P. 86)**

→ Are you printing on curled envelopes?

- Uncurl the envelopes, and print again.
▶ **Loading Envelopes(P. 92)**

Paper Is Not Fed/Two or More Sheets Are Fed Together



→ Is paper loaded correctly?

- Fan the paper stack thoroughly so that paper is not stuck together.
- Check whether paper is loaded correctly.
▶ **Loading Paper(P. 86)**
- Check whether the number of sheets of paper loaded is appropriate and whether the appropriate paper is used.
▶ **Available Paper(P. 325)**
▶ **Loading Paper(P. 86)**
- Check whether mixed sizes and types of paper are loaded together.
- There are cases where the paper does not load properly depending on its thickness. If this occurs, reverse the paper orientation, or flip the paper over.

A Message or a Number Starting with "#" (an Error Code) Is Displayed

38CS-065

When a message appears on the machine's display, or a number (error code) prefixed with "#" appears, see the following sections to check the solution.

- ▶ **Countermeasures for Each Message(P. 296)**
- ▶ **Countermeasures for Each Error Code(P. 305)**

Countermeasures for Each Message

38CS-066

A message appears on the display when there is a problem with copy or print processing, when the machine cannot communicate, or when some other problem prevents normal operation. Find out more information about messages in the following list.

A counterfeit or non-Canon drum cartridge may be in use.

The drum cartridge used may not be a genuine Canon product.

- Only genuine Canon drum cartridges should be used as replacement drum cartridges.
 ▶ **Consumables(P. 268)**

Amount in cart. cannot be displ. correctly.

The drum cartridge is not installed correctly, or there is possible trouble on the drum cartridge.

- Reinstall the drum cartridge. If this message does not disappear after reinstalling several times, the drum cartridge might be possibly broken. Contact the store where you purchased the drum cartridge, or consult the Canon Customer Help Center.
 ▶ **Replacing the Drum Cartridge(P. 258)**

You might not be using a Canon genuine drum cartridge.

- We recommend Canon genuine drum cartridges as replacement drum cartridges.
 ▶ **Consumables(P. 268)**

Cannot find the access point.

When automatic setting with WPS was attempted, a wireless router could not be detected within a specific period of time.

- Connect again paying attention to the time limit.
 ▶ **Setting Up Connection Using WPS Push Button Mode(P. 17)**
 ▶ **Setting Up Connection Using WPS PIN Code Mode(P. 19)**

An SSID of a wireless router was entered, but the entry was incorrect.

- Check the SSID and enter the correct one again.
 ▶ **Checking the SSID and Network Key(P. 26)**
 ▶ **Setting Up Connection by Specifying Detailed Settings(P. 23)**

A wireless router could not be detected due to setting problems of the network to be connected.

- Check whether the machine is properly installed and ready to connect to the network.
 ▶ **Installation/Settings Problems(P. 275)**
- If the problem persists, check the security settings of the wireless router.

Cart. Comm. Error A counterfeit or non-Canon drum cart. may be in use.

The drum cartridge may not be installed correctly or may be faulty.

- Re-install the drum cartridge. If re-installing the drum cartridge fails to clear the error message, the drum cartridge may be faulty. Contact the store where you purchased the drum cartridge or consult the Canon Customer Help Center.
 - ▶ **Procedure for Replacing the Drum Cartridge(P. 259)**

Check the authentication settings.

The authentication method set on the machine does not match the authentication method set on the RADIUS server.

- Check that the same authentication method is set on this machine and the RADIUS server, and set the correct authentication method.
 - ▶ **Configuring IEEE 802.1X Authentication Settings(P. 189)**

Cooling down... Wait a moment, then try again.

The temperature of the fixing assembly is high.

- Wait for a while until the fixing assembly cools down. After the temperature of the fixing assembly falls, try the operation again.

Cooling down... Wait a moment.

The temperature of the fixing assembly is high.

- Wait for a while until the fixing assembly cools down. After the temperature of the fixing assembly falls, the message will disappear.

Could not connect. (for Access Point Mode connection)

Connection in Access Point Mode failed due to an error.

- Wait a few moments and try again. If you still cannot connect, turn OFF the machine, and then turn it back on again.
 - ▶ **Connecting Directly (Access Point Mode)(P. 142)**

Could not connect. (for Easy Connection via PC connection)

An error has occurred while starting Easy Connection via PC (cableless setup mode).

- Press the [Back] key to return to the previous screen, and then try <Easy Connection via PC> again.

- If the same message still appears after retrying <Easy Connection via PC>, turn OFF the machine, and then turn it back on again.

Could not connect. Check the PSK settings.

The network key (PSK) of a wireless router to be connected is not set to the machine correctly.

- Check the network key (PSK) of the wireless router, and set it to the machine again.
 - ▶ **Checking the SSID and Network Key(P. 26)**
 - ▶ **Setting Up Connection by Selecting a Wireless Router(P. 21)**
 - ▶ **Setting Up Connection by Specifying Detailed Settings(P. 23)**
- If the problem persists even after checking the network key, check whether the machine is properly installed and ready to connect to the network.
 - ▶ **Installation/Settings Problems(P. 275)**

Could not connect using the wireless LAN. (for wireless LAN connection)

A connection failed due to an error while setting wireless LAN connection.

- Restart the machine and set again.
- If the problem persists even after restarting the machine, check whether the machine is properly installed and ready to connect to the network.
 - ▶ **Installation/Settings Problems(P. 275)**
- If the problem persists even after checking the wireless LAN connection, check the security settings of the wireless router.

Could not connect using the wireless LAN. (for wireless LAN communication)

Wireless LAN communication failed due to an error.

- Wait for a while, and set again. If you still cannot get connection, turn OFF the machine and then restart it.

Could not connect using WPS.

When automatic setting with WPS was attempted, the connection failed due to an error.

- Wait for a while, and set again. If the problem persists, check whether the wireless router supports WPS.

If WPS is supported:

Check whether the machine is properly installed and ready to connect to the network.

- ▶ **Installation/Settings Problems(P. 275)**

If WPS is not supported:

Set using another connecting method.

- ▶ **Connecting to a Wireless LAN(P. 15)**

Could not detect any connections from wireless devices.

Mobile device detection was not possible within the predetermined length of time.

- Connect again paying attention to the time limit.
 - ▶ **Connecting Directly (Access Point Mode)(P. 142)**

Could not perform cleaning.

Paper jammed during cleaning.

- Remove the jammed paper, set paper correctly, and perform cleaning again.
 - ▶ **Clearing Paper Jams(P. 306)**
 - ▶ **Cleaning the Fixing Assembly(P. 254)**

Could not perform Shared Key auth. Check WEP settings.

The network key (the WEP key) of a wireless router to be connected is not set to the machine correctly.

- Check the network key (the WEP key) of the wireless router, and set it to the machine again.
 - ▶ **Checking the SSID and Network Key(P. 26)**
 - ▶ **Setting Up Connection by Specifying Detailed Settings(P. 23)**
- Connect again by selecting a wireless router or by manually changing the WEP authentication method to <Open System>.
 - ▶ **Setting Up Connection by Selecting a Wireless Router(P. 21)**
 - ▶ **Setting Up Connection by Specifying Detailed Settings(P. 23)**

The authentication method of the machine is set to <Shared Key>, but that of the wireless router is set to "Open System."

- Change the WEP authentication method to "Shared Key" at the wireless router, and connect again. For more information about how to change, see the instruction manuals for your networking devices or contact your manufacturer.

Could not set the current date and time.

The communication failed due to a network error and a timeout occurred.

- Check the network environment that the machine connects with.
- Use <Current Date/Time Settings> to set the time manually, or, in [SNTP Settings], clear the [Use SNTP] check box.
 - ▶ **Setting the Current Date and Time(P. 9)**
 - ▶ **Configuring SNTP(P. 58)**

Could not update the device time because its battery has run out. Cannot use Google Cloud Print if the time settings are incorrect.

The machine's battery has run out and the correct time settings could not be kept.

- Set the correct time again.
 - ▶ **Setting the Current Date and Time(P. 9)**

Direct Connection terminated.

Connection with the mobile device was interrupted.

- Establish Direct Connection again.
 - ▶ **Connecting Directly (Access Point Mode)(P. 142)**

Drum cart. reached end of lifetime.

The drum cartridge has reached the end of its lifetime.

- Replace the drum cartridge with a new one.
 - ▶ **Replacing the Drum Cartridge(P. 258)**

Easy Connection via PC ended due to timeout.

A connection to the computer has not been established for 30 minutes since Easy Connection via PC (cableless setup mode) started.

- Press the [Back] key to return to the previous screen, and then try <Easy Connection via PC> again.

Google Cloud Print not avail. Server auth err

Cloud Print could not perform server authentication, or could not acquire information for registration.

- Check whether the date and time settings are correctly specified.
 - ▶ **<Date/Time Settings>(P. 227)**

Google Cloud Print not avail. Server comm err

Cloud Print is unavailable due to an error.

- Check whether the machine is correctly connected to a wired LAN or a wireless LAN.
 - ▶ **Connecting to a Wired LAN(P. 14)**
 - ▶ **Connecting to a Wireless LAN(P. 15)**
- A port that is used for Cloud Print may be blocked by a firewall or other protection. Check whether the 5222 port is available with your computer.

- If a proxy server is used on the network, check whether the proxy settings on the machine and the server are correct. For details, contact your Network Administrator.
 - ▶ **Setting a Proxy(P. 177)**

Incorrect number of characters/invalid characters entered.

The network key (the WPA/WPA2-PSK or WEP key) of a wireless router is not entered correctly.

- Check the network key (the WPA/WPA2-PSK or WEP key) of the wireless router, and set it to the machine again. For more information about how to check the network key, see the instruction manuals for your networking devices or contact your manufacturer.
 - ▶ **Checking the SSID and Network Key(P. 26)**
 - ▶ **Setting Up Connection by Selecting a Wireless Router(P. 21)**
 - ▶ **Setting Up Connection by Specifying Detailed Settings(P. 23)**

Insert the drum cartridge.

The drum cartridge is not set or properly set.

- Properly set the drum cartridge.
 - ▶ **Replacing the Drum Cartridge(P. 258)**

No Paper: Drawer 1

Paper is not loaded in the drawer.

- Load the paper.
 - ▶ **Loading Paper(P. 86)**

Paper on which reports or lists can be printed is not loaded.

- Reports or lists can be printed on A4 or Letter size paper. Load A4 or Letter size paper and set its size.
 - ▶ **Loading Paper(P. 86)**
 - ▶ **Specifying Paper Size and Type(P. 95)**

No reply from the destination.

A network cable may be disconnected, or there may be a problem in a switch.

- Check the status of the network cables and switches.

No response from host.

The machine is not connected to a network correctly.

- Check the machine and network settings, and connect again.
 - ▶ **Setting Up the Network Environment(P. 11)**

Paper jammed.

Paper jams.

- Remove the jammed paper, and print again (Printing may resume automatically).
 ▶ **Clearing Paper Jams(P. 306)**

Preparing a drum cart. is recommended.

Drum cartridge replacement time is near.

- Replace the drum cartridge if you see this message before you start to print a large job.
 ▶ **Consumables(P. 268)**

Preparing a toner cart. is recommended.

Toner cartridge replacement time is near.

- Replace the toner cartridge if you see this message before you start to print a large job.
 ▶ **Consumables(P. 268)**

Set the correct authentication information.

The client authentication information (key and certificate, user name and password, or CA certificate) is not set correctly.

- Check the specified authentication method and authentication information (key and certificate, user name and password, and CA certificate).
 ▶ **Configuring IEEE 802.1X Authentication Settings(P. 189)**

Size/Settings Mismatch

The paper size setting on the operation panel does not match the loaded paper size.

- Match the paper size setting specified in <Paper Settings> and the size of the paper that is actually loaded.

To use the loaded paper

Change the setting of <Paper Settings> to match the loaded paper size.

- ▶ **Specifying Paper Size and Type(P. 95)**

NOTE:

- If printing from a computer, check whether the paper size setting in the printer driver matches the loaded paper size.

To load paper without changing the settings

Load the paper with the size that is set to <Paper Settings>.

- ▶ **Loading Paper(P. 86)**

The connection with the PC has been lost. Check the connection.

The connection to the computer was lost during a scan.

- Check the connection between the machine and the computer.
 - ▶ **Preparing to Use the Machine as a Scanner(P. 62)**

The memory is full. Scanning will be canceled. Print?

A document could not be scanned due to insufficient memory space.

- Copy the document in two or more parts.

The WEP key is not set correctly. Check the WEP settings.

The network key (the WEP key) of a wireless router to be connected is not set to the machine correctly.

- Check the network key (the WEP key) of the wireless router, and set it to the machine again.
 - ▶ **Checking the SSID and Network Key(P. 26)**
 - ▶ **Setting Up Connection by Selecting a Wireless Router(P. 21)**
 - ▶ **Setting Up Connection by Specifying Detailed Settings(P. 23)**

The authentication method of the machine is set to <Shared Key>, but that of the wireless router is set to "Open System."

- Connect again by selecting a wireless router or by manually changing the WEP authentication method to <Open System>.
 - ▶ **Setting Up Connection by Selecting a Wireless Router(P. 21)**
 - ▶ **Setting Up Connection by Specifying Detailed Settings(P. 23)**
- Change the WEP authentication method to "Shared Key" at the wireless router, and connect again. For more information about how to change, see the instruction manuals for your networking devices or contact your manufacturer.

Toner cart. reached end of lifetime.

The toner cartridge has reached the end of its lifetime.

- Replace the toner cartridge with a new one.
 - ▶ **Replacing the Toner Cartridge(P. 255)**

Turn main power OFF and ON. If device does not recover, contact your dealer or service representative.

An error has occurred with the machine.

- Turn OFF the power switch, wait 10 seconds, and turn it back ON. If the problem persists, turn OFF the power switch, disconnect the power cord, and contact your local authorized Canon dealer or the Canon help line. Be sure to provide the displayed <Ennn-nnnn>.

Use Remote UI to set info. necessary for authentication.

The IEEE 802.1X settings are incorrect.

- Check whether [Login Name] is set correctly.
 - Check whether the [Use TLS], [Use TTLS], or [Use PEAP] check box is selected.
 - If using TLS, check whether a "key and certificate" is registered.
 - If using TTLS or PEAP, check whether a user name and password are set correctly.
- ▶ **Configuring IEEE 802.1X Authentication Settings(P. 189)**

Countermeasures for Each Error Code

38CS-067

If an error occurs such as when printing is not successful, the corresponding error code is displayed in the job log screen as a three-digit number. Check the following to find out causes and solutions for each error code. For details of the job log screen, see [▶<Status Monitor> Screen\(P. 79\)](#) .

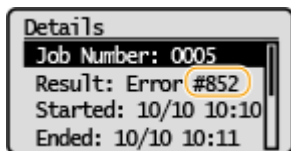

#852

The machine turns OFF for some reason.

- Check whether the power plug is inserted into an outlet firmly.

#853

A document could not be printed because its data size exceeded the machine's upper processing capability.

- The machine may not be able to print documents with many pages. Reduce the number of pages per printing, or print when no print job is queued or no document is being printed. If you are still unable to print, check the document data for any defects.

Printing was canceled from the computer.

- If you cancel an operation when the print data is being sent to the machine from a computer, this error code is displayed, but this is not abnormal. Print again as necessary.

Clearing Paper Jams

If a paper jams, <Paper jammed.> is displayed on the screen. Press ► to display simple solutions. If it is difficult to understand the procedures on the display, see the following sections to clear jams.

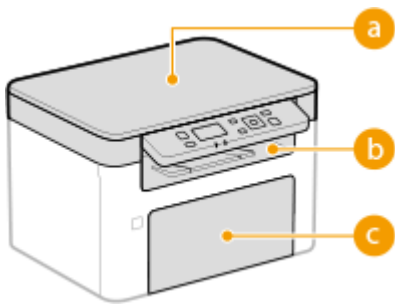
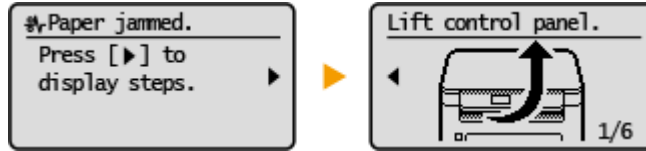

- a Inside of the machine**
 - ▶ Paper Jams inside the Machine(P. 307)
- b Output tray**
 - ▶ Paper Jams inside the Machine(P. 307)
- c Drawer**
 - ▶ Paper Jams inside the Machine(P. 307)

IMPORTANT

When removing the jammed paper, do not turn OFF the machine

- Turning OFF the machine deletes the data that is being printed.

If paper tears

- Remove all the paper fragments to prevent them from becoming jammed.

If paper jams repeatedly

- Tap the paper stack on a flat surface to even the edges of the paper before loading it into the machine.
- Check that the paper is appropriate for the machine. ▶ Available Paper(P. 325)
- Check that no jammed paper fragments remain in the machine.
- If you use paper with a coarse surface, set <Paper Type> to <Bond 1 (60-104 g/m²)> or <Bond 2 (105-163 g/m²)>.
 - ▶ Specifying Paper Size and Type in the Drawer(P. 96)
 - ▶ Printing from a Computer(P. 119)

Do not forcibly remove the jammed paper from the machine

- Forcibly removing the paper may damage parts. If you are not able to remove the paper, contact your local authorized Canon dealer or the Canon help line. ▶ When a Problem Cannot Be Solved(P. 310)

Paper Jams inside the Machine

38CS-069

Remove the jammed paper according to the procedure below. Do not forcibly remove jammed paper from the machine. If the jammed paper cannot be removed easily, proceed to the next step.

- 1 Lift the operation panel, close the paper stopper, and then open the toner cover.**

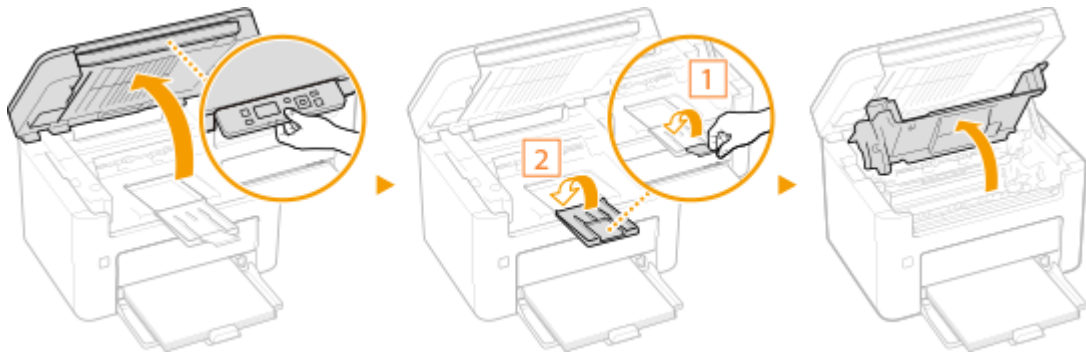

- 2 Remove the drum cartridge.**

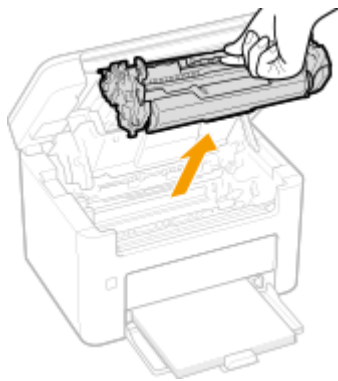

IMPORTANT:

Do not shake or tilt the drum cartridge. Also, make sure to avoid applying shocks to the drum cartridge, such as by hitting it against something. Doing so may cause the toner left in the drum cartridge to leak. Remove the drum cartridge gently at the same angle as the slot.

- 3 Gently pull out the paper.**

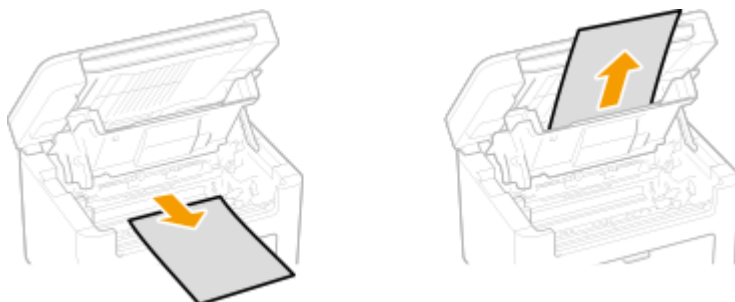

- 4 Check whether paper is jammed inside the machine.**

1 Gently pull out the paper.

- Hold both edges of the paper, pull the leading edge of the paper down, and then pull it out.

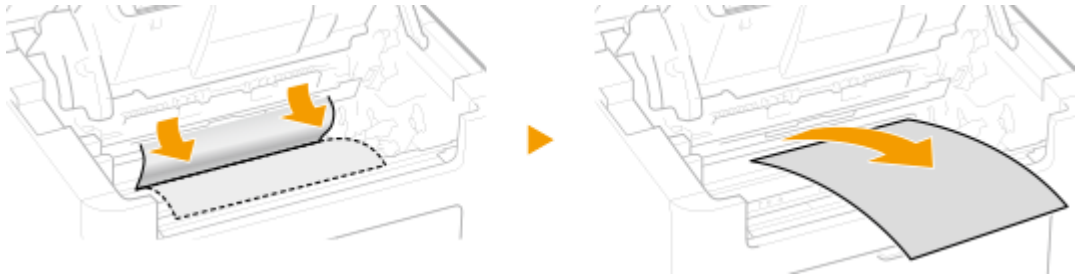

5 Check whether paper is jammed in the drawer.

1 Remove the paper cover.

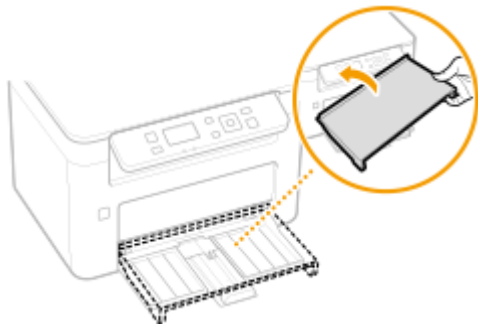

2 Remove any loaded paper.



3 Gently pull out the jammed paper.



4 Load the paper.



5 Replace the paper cover.

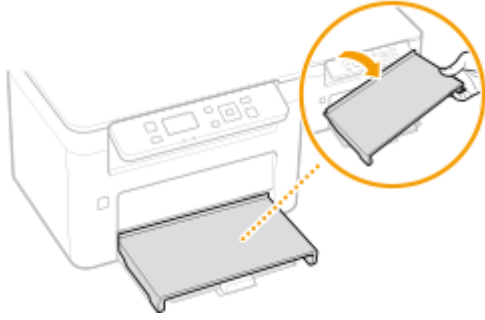

6 Insert the drum cartridge.

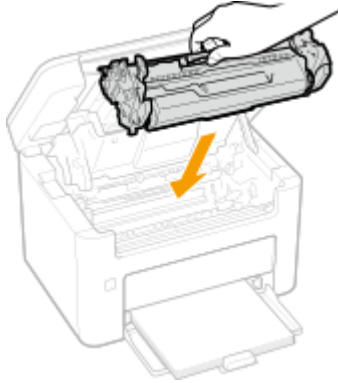

7 Close the toner cover.

⇒ The paper jam message disappears, and the machine is ready to print.

When a Problem Cannot Be Solved

38CS-06A

If you cannot solve a problem by referring to the information in this chapter, contact your local authorized Canon dealer or the Canon help line.

IMPORTANT

Do not disassemble or repair the machine yourself

- If you disassemble or repair the machine yourself, it may not be covered by warranty.

■ When Contacting Canon

When contacting us, have the following information ready:

- Product name (MF913w / MF912)
- Dealer where you purchased the machine
- Details about your problem (such as what you did and what happened as a result)
- Serial number (found on the label on the back side of the machine)

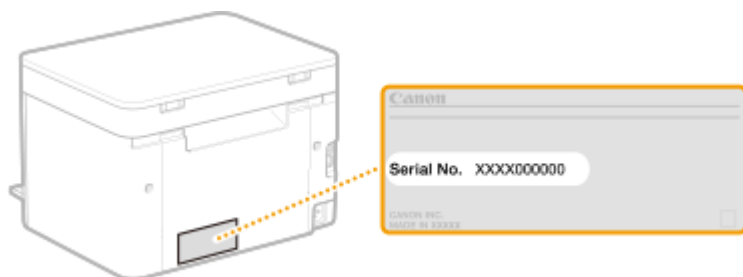

NOTE

Checking the serial number from the operation panel

- Select <Status Monitor> ► <Device Information> ► <Serial Number>.

Appendix

Appendix	312
Third Party Software	313
Feature Highlights	314
Going Green and Saving Money	315
Improving Efficiency	316
Going Digital	317
So Much More	319
Specifications	321
Main Unit	322
Available Paper	325
Scan Function	327
Printer Functions	328
Management Functions	329
System Environment	330
Network Environment	331
Manuals and Their Contents	332
Using User's Guide	333
Screen Layout of User's Guide	334
Viewing User's Guide	337
Basic Windows Operations	338
Notice	346

Appendix

38CS-06C

This chapter contains technical specifications of this machine, instructions on how to use the User's Guide, disclaimers, copyright information, and other important information for customers.

■ Machine Specifications

See the following section(s) when you want to check the specifications of the machine, network environment, print function, and so on.



▶ **Specifications(P. 321)**

■ Referencing the Manual of This Machine

See the first of the following sections when you want to be sure of the kinds of the manuals describing the functions of the machine and how to operate the machine. When you want to know how to read and use the User's Guide (this manual), see the second section.



▶ **Manuals and Their Contents(P. 332)**

▶ **Using User's Guide(P. 333)**

■ Others

See the following section(s) when you want to get useful information, and check the disclaimers and copyright information.



▶ **Third Party Software(P. 313)**

▶ **Feature Highlights(P. 314)**

▶ **Basic Windows Operations(P. 338)**

▶ **Notice(P. 346)**

Third Party Software

38CS-06E

For information related to third-party software, click the following icon(s).

MF913w



MF912



Feature Highlights

38CS-06F

This section describes tips for leveraging the features of the machine by category. You can make use of the features according to your intended purposes and operating environment.

- ▶ **Going Green and Saving Money(P. 315)**
- ▶ **Improving Efficiency(P. 316)**
- ▶ **Going Digital(P. 317)**
- ▶ **So Much More(P. 319)**

Going Green and Saving Money

38CS-06H



There are lots of ways to cut back on paper, toner, power, and expenses.



Print Multiple Pages on a Single Sheet

To really start saving paper, shrink multiple pages onto one side of a sheet - 2 or 4 pages for copies, and up to 16 pages for print jobs sent from your computer.

- ▶ **Copying Multiple Documents onto One Sheet (N on 1) (P. 114)**
- ▶ **Printing from a Computer(P. 119)**



Sleep Mode

For saving energy and money, a sleep mode that powers down a machine when nobody is using it has become an essential feature. This machine will enter sleep mode automatically.

- ▶ **Entering Sleep Mode(P. 102)**

Improving Efficiency

38CS-06J



Here are some simple operations that can make complicated tasks more efficient.



Remote Management with Remote UI

Remote UI lets you manage a lot from your computer, all without having to go over to the machine. Configure settings and keep an eye on the machine's status with an intuitive, easy-to-understand Web browser interface that you'll master immediately. Save your time and energy for things other than taking care of the machine.

▶ **Managing the Machine from a Computer (Remote UI) (P. 197)**

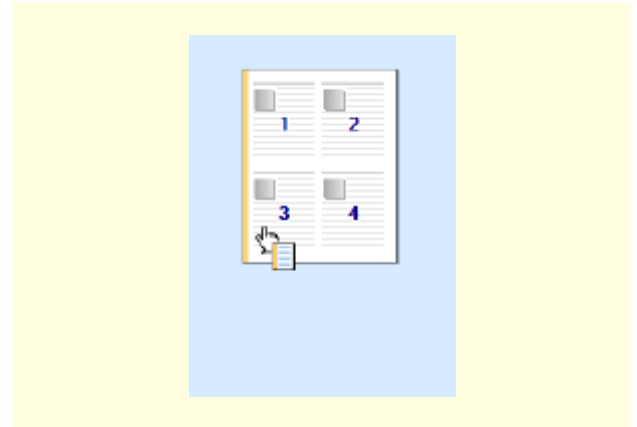

Make Print Settings Quickly with Intuitive Operation

You can easily specify the page layout as well as binding position, etc. intuitively on the preview image in the printer driver. The simple click-operation allows you to conveniently make settings while viewing how settings are applied.

▶ **Printing from a Computer(P. 119)**

Going Digital

38CS-06K



Digitalizing a document enables editing using a computer as well as reducing cost and time by using e-mail.



Scan Only What You Need

What if you're scanning a whole page of a newspaper but all you're really interested in is a headline and a photo? Use ScanGear MF. You can select what you want from a preview, and then have the scanner disregard the rest. Otherwise you'll have to use an editing program to crop out everything you don't need.

► **Using ScanGear MF (P. 137)**



Searchable PDFs

Searching of text in a PDF can be done with a "searchable PDF." By scanning an original with both text and images, text portions are converted by OCR into text data. In addition to being able to search for text information, you can also copy required portions into an Excel spreadsheet or Word document in Microsoft Office. Eliminate the need to type in customer data, addresses, etc. from scratch.

► **Basic Operations for Scanning Originals (P. 127)**

► **Using Your Computer to Scan (Remote Scan) (P. 134)**

IMPORTANT

- Using your product to scan, print or otherwise reproduce certain documents, and the use of such images as scanned, printed or otherwise reproduced by your product, may be prohibited by law and may result in criminal and/or civil liability. If you are uncertain about the legality of using your product to scan, print or otherwise reproduce any particular document, and/or of the use of the images scanned, printed or otherwise reproduced, you should consult in advance with your legal advisor for guidance.



Add Images to a Work in Progress

Some applications work with the machine to let you easily import scanned images directly into documents you're working on. This way you can skip the steps of opening a separate application just for receiving the scanned images and then exporting them to the application you're really using.

▶ **Scanning Documents from an Application(P. 135)**

So Much More

38CS-06L



There are a variety of features for whatever you need to do - at home, in the office, or even on the road.



Using a smartphone/tablet

At times such as when you want to quickly print out a proposal you completed on a tablet while travelling to a business destination, Canon PRINT Business comes in handy. Even in environments without a wireless LAN router, you can connect to the machine with a mobile device wirelessly and directly.

PCless, quick, and easy! An even broader range of possibilities for work/play with functionality made for this age of speed.

▶ **Linking with Mobile Devices(P. 139)**



Easy Printing with Google Cloud Print

Hook up to Google Cloud Print with your laptop or cell phone, send your data, and out come your printed documents. With this machine, Google Cloud Print, and your mobile device, print whenever you want from wherever you want.

▶ **Using Google Cloud Print(P. 157)**

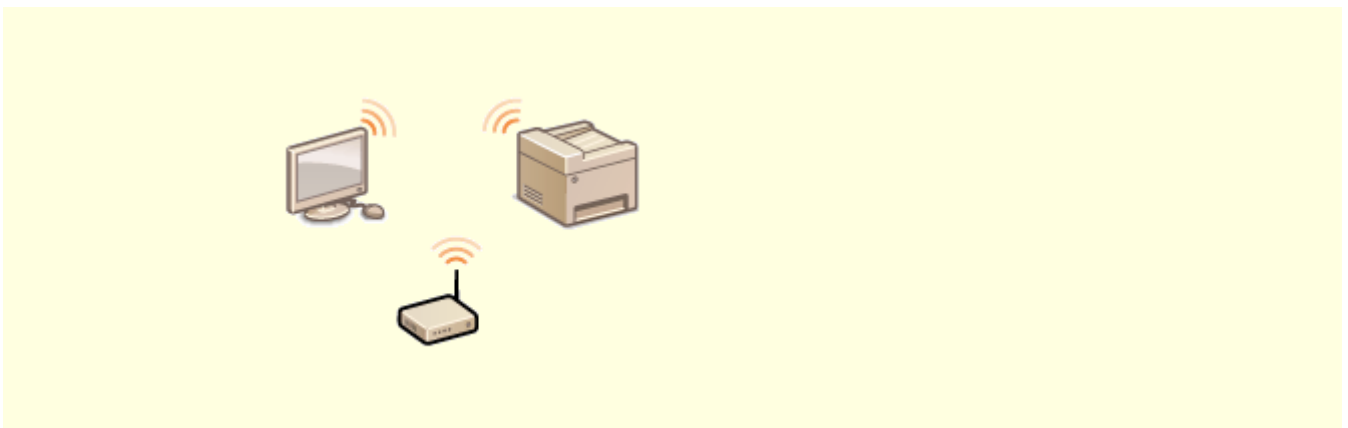

Go Wireless

No cables, easy installation, simple maintenance. If you've got a WPS wireless LAN router, bypass the settings process altogether and be ready to go before you know it. Enjoy the kind of clutter-free and easy to use document system that you can only get from wireless. Compatible with IEEE 802.11b/g/n for stress-free wireless, and also supports WEP and WPA/WPA2-PSK (TKIP/AES-CCMP) for tighter security.

▶ **Connecting to a Wireless LAN(P. 15)**

Specifications

38CS-06R

Specifications are subject to change without notice for product improvement or future release.

■ Machine Specifications

- ▶ **Main Unit(P. 322)**
- ▶ **Available Paper(P. 325)**

■ Functional Specifications

- ▶ **Scan Function(P. 327)**
- ▶ **Printer Functions(P. 328)**
- ▶ **Management Functions(P. 329)**

■ Environment To Use the Machine

- ▶ **System Environment(P. 330)**
- ▶ **Network Environment(P. 331)**

Main Unit

38CS-06S

NOTE

- For information on paper sizes and types for this machine, see " [▶ Available Paper\(P. 325\)](#) ."

Name	Canon imageCLASS MF913w / MF912
Type	Desktop
Color Supported	Black and White
Resolution for Reading	600 dpi x 600 dpi
Resolution for Writing	600 dpi x 400 dpi (at default speed) 600 dpi x 600 dpi (at 2/3 speed)
Number of Tones	256
Acceptable Originals	Up to 215.9 mm x 297.0 mm Maximum thickness of original: 1 sheet
Copy Size/Copy Paper	<p>Paper Sizes</p> <ul style="list-style-type: none"> • Max: 215.9 mm x 355.6 mm • Min: 76.2 mm x 127.0 mm <p>Margin</p> <ul style="list-style-type: none"> • Top: 5.0 mm ± 2.0 mm • Left or Right: 5.0 mm ± 2.0 mm <p>Paper Weight</p> <p>60 g/m² to 163 g/m²</p>
Paper Type	▶ Available Paper(P. 325)
Warm-Up Time ^{*1}	<p>MF913w:</p> <p>After Powering ON</p> <p>15.0 seconds or less</p> <p>Returning from the Sleep mode</p> <p>1.6 seconds or less</p> <p>MF912:</p> <p>After Powering ON</p> <p>15.0 seconds or less</p> <p>Returning from the Sleep mode</p>

	1.6 seconds or less
First Copy Time (A4)	Approx. 9.3 seconds
Copy Speed *2 (Plain A4)	22.0 sheets/minute
Magnification	25 % to 400 % (in 1 % increments)
Paper Feeding Capacity *3	150 sheets (80 g/m ²)/150 sheets (64 g/m ²)
Paper Output Capacity *3	100 sheets (68 g/m ²)
Multiple Copies	999 sheets
Power Source	AC 220 V - 240 V, 1.5 A, 50 Hz/60 Hz
Power Consumption *1	<p>MF913w:</p> <p>Maximum Power Consumption</p> <p>910 W or less</p> <p>During Sleep Mode</p> <ul style="list-style-type: none"> ● Approx. 0.7 W (USB connection) ● Approx. 0.7 W (Wired LAN connection) ● Approx. 0.8 W (Wireless LAN connection) <p>With the Main Power Turned OFF</p> <p>0.5 W or less</p> <p>MF912:</p> <p>Maximum Power Consumption</p> <p>910 W or less</p> <p>During Sleep Mode</p> <p>Approx. 0.7 W</p> <p>With the Main Power Turned OFF</p> <p>0.5 W or less</p>
Dimensions (W x D x H)	372 mm x 320 mm x 255 mm
Weight	<p>MF913w:</p> <p>Main Unit *4</p> <p>Approx. 8.4 kg</p> <p>Consumables</p> <p>🔴 Consumables(P. 268)</p> <p>MF912:</p> <p>Main Unit *4</p>

	Approx. 8.4 kg Consumables ▶ Consumables(P. 268)
Installation Space (W x D)	See "Getting Started". ▶ Manuals and Their Contents(P. 332)
Memory Capacity	MF913w: RAM: 256 MB MF912: RAM: 128 MB
Environmental Conditions	Temperature: 10°C to 30°C Humidity: 20% to 80% RH (no condensation)

*1May vary depending on the environment and conditions under which the machine is being used.

*2Copy/print speeds are measured based on internal testing using A4 size paper copied/printed with 100% copy/print ratio to original on one-sided paper. Internal testing involved continuously copying/printing the same one page of content on plain paper (copy speed is tested by copying on the platen glass). Copy/print speeds may vary depending on paper type, paper size or paper feeding direction.
The device may automatically pause or slow down in order to adjust printer condition such as controlling temperature of a certain unit or limiting impact to image quality during continuous copying/printing.

*3May vary depending on the installation environment and paper to use.

*4The toner cartridge and the drum cartridge are not included.

Available Paper

38CS-06U

The paper types that can be used with this machine are shown in the following table.

■ Supported Paper Sizes

Paper sizes that can be loaded in the drawer is listed below.

- A4** (210.0 mm x 297.0 mm)
- B5** (182.0 mm x 257.0 mm)
- A5** (148.0 mm x 210.0 mm)
- A6** (105.0 mm x 148.0 mm) *¹
- Letter** (215.9 mm x 279.4 mm)
- Legal** (215.9 mm x 355.6 mm)
- Executive** (184.1 mm x 266.7 mm)
- Statement** (139.7 mm x 215.9 mm)
- Oficio** (215.9 mm x 317.5 mm)
- Oficio (Brazil)** (215.9 mm x 355.0 mm)
- Oficio (Mexico)** (215.9 mm x 341.0 mm)
- Envelope Monarch** (98.4 mm x 190.5 mm)
- Envelope No. 10 (COM10)** (104.7 mm x 241.3 mm)
- Envelope DL** (110.0 mm x 220.0 mm)
- Envelope C5** (162.0 mm x 229.0 mm)
- Letter (Government)** (203.2 mm x 266.7 mm)
- Legal (Government)** (203.2 mm x 330.2 mm)
- Legal (India)** (215.0 mm x 345.0 mm)
- F4A** (215.9 mm x 343.0 mm)
- Foolscap** (215.9 mm x 330.2 mm)
- Foolscap (Australia)** (206.0 mm x 338.0 mm)
- 3x5inch** (76.2 mm x 127.0 mm)
- Custom** *²

*¹Available only from the printer driver.

*²Custom paper size of 76.2 mm to 215.9 mm in width and 127.0 mm to 355.6 mm in length can be loaded in the drawer.

■ Supported Paper Types

Chlorine-free paper can be used with this machine.

✓ : Available

Paper Type		Drawer
Plain	71 to 89 g/m ²	✓
Plain L	61 to 70 g/m ²	✓
Plain L2	60 g/m ²	✓
Recycled	71 to 89 g/m ²	✓
Heavy 1	90 to 120 g/m ²	✓
Heavy 2	121 to 163 g/m ²	✓
Heavy 3 ^{*1}	121 to 163 g/m ²	✓
Bond 1	60 to 104 g/m ²	✓
Bond 2	105 to 163 g/m ²	✓
Labels ^{*2}		✓
Envelope		✓
Envelope H ^{*3}		✓
Index Card	121 to 163 g/m ²	✓

^{*1}When using paper of 121 to 163 g/m² with <Heavy 2> specified, select this paper type if toner is not fully fixed and the printouts are faded.

^{*2}Use A4 or Letter size only.

^{*3}Select this paper type if toner is not fully fixed and the printouts are faded when the paper type is set to <Envelope>.

Scan Function

38CS-06W

Type	Color Scanner
Original Scanning Size (Max)	215.9 mm x 297.0 mm
Resolution (Max)	600 dpi x 600 dpi
Interface	USB USB 1.1 Full-Speed, USB 2.0 Hi-Speed Wired LAN 10Base-T, 100Base-TX (IEEE 802.3 compliant) Wireless LAN IEEE 802.11b, IEEE 802.11g, IEEE 802.11n
Protocol Supported *	TCP/IP, USB
Output Format *	Standard: TIFF, JPEG/Exif, PNG, PDF, PDF (Divided into Single-Page Files) Optional: PDF Compression (Standard, High), Searchable PDF

*Some formats are not supported depending on the function.

Printer Functions

38CS-06X

Type	Internal
Print Size	▶ Available Paper(P. 325)
Print Speed	Same as "Copy Speed" on ▶ Main Unit(P. 322)
Resolution	Data Processing 600 dpi x 400 dpi, 600 dpi x 600 dpi
Page Description Language (PDL)	UFR II-LT
Protocol Supported	TCP/IP: LPD, Port9100, IPP, IPPS, WSD
Resident Fonts	None
Interface	USB USB 1.1 Full-Speed, USB 2.0 Hi-Speed Wired LAN 10Base-T, 100Base-TX (IEEE 802.3 compliant) Wireless LAN IEEE 802.11b, IEEE 802.11g, IEEE 802.11n

Management Functions

■ Firewall Settings

- Up to 4 IP addresses (or ranges of IP addresses) can be specified for both IPv4 and IPv6.
- Up to 10 MAC addresses can be specified.

■ Registration of Keys and Certificates

- If you install a key or CA certificate from a computer, make sure that they meet the following requirements:

Format	<ul style="list-style-type: none"> • Key: PKCS#12^{*1} • CA certificate: X.509 DER, PEM
File extension	<ul style="list-style-type: none"> • Key: ".p12", ".pfx" • CA certificate: ".cer"
Public key algorithm (and key length)	<ul style="list-style-type: none"> • RSA (512 bits^{*2}, 1024 bits, 2048 bits, 4096 bits) • ECDSA (P256, P384, P521)
Certificate signature algorithm	<ul style="list-style-type: none"> • RSA: SHA1^{*3}, SHA256, SHA384^{*4}, SHA512^{*4}, MD2^{*5}, MD5^{*5} • ECDSA: SHA1^{*3}, SHA256, SHA384, SHA512

^{*1}Requirements for the certificate contained in a key are pursuant to CA certificates.

^{*2}The signature algorithm is available only for SHA1-RSA or SHA256-RSA.

^{*3}Available only for a generated key and certificate signature request (CSR) or installation from the Remote UI.

^{*4}Available only when the key algorithm is 1024 bits or more.

^{*5}Available only for installation from the Remote UI.

NOTE

- The machine does not support use of a certificate revocation list (CRL).

System Environment

38CS-070

System Environment for WSD Scan	<ul style="list-style-type: none"> • Windows Vista • Windows 7 • Windows 8.1 • Windows 10
System Requirements for the Remote UI *1	<p>Windows</p> <ul style="list-style-type: none"> • Windows Vista / 7 / 8.1 / 10: Internet Explorer 11 or later • Windows 10: Edge <p>macOS</p> <ul style="list-style-type: none"> • Mac OS X 10.6 or later • Safari 3.2.1 or later <p>iOS</p> <ul style="list-style-type: none"> • Safari <p>Android</p> <ul style="list-style-type: none"> • Chrome
System Requirements for the User's Guide	<p>Windows</p> <ul style="list-style-type: none"> • Internet Explorer 9 or later • Microsoft Edge • Firefox • Firefox ESR • Chrome*2 <p>macOS</p> <ul style="list-style-type: none"> • Safari • Firefox • Chrome*2 <p>Linux</p> <ul style="list-style-type: none"> • Firefox <p>iOS</p> <ul style="list-style-type: none"> • Safari*2 <p>Android</p> <ul style="list-style-type: none"> • Chrome*2

*1Before changing the settings of the machine, set your Web browser to enable all cookies and use JavaScript.

*2Only when viewing manuals on the Internet

Network Environment

38CS-071

■ Common Specifications

Protocol Supported	TCP/IP <ul style="list-style-type: none"> ● Frame type: Ethernet II ● Print applications: LPD, Raw, IPP, IPPS, WSD, Mopria, Google Cloud Print, AirPrint, Windows10 Mobile Print
---------------------------	---

■ Wired LAN Specifications

Interface	10Base-T, 100Base-TX (RJ-45)
------------------	------------------------------





■ Wireless LAN Specifications

Standard	IEEE 802.11b, IEEE 802.11g, IEEE 802.11n
Transmission Scheme	IEEE 802.11b (Modulation system: DS-SS) IEEE 802.11g (Modulation system: OFDM method) IEEE 802.11n (Modulation system: OFDM method)
Frequency Range	2.412 GHz to 2.472 GHz
Maximum Radio-Frequency Power	15.9 dBm
Communication Mode	<ul style="list-style-type: none"> ● Infrastructure Mode ● Access Point Mode
Security (encryption method)	Infrastructure Mode <ul style="list-style-type: none"> ● 128 (104)/64 (40) bit WEP ● WPA-PSK (TKIP/AES-CCMP) ● WPA2-PSK (TKIP/AES-CCMP) Access Point Mode WPA2-PSK (AES-CCMP)
Connection Method	WPS (Wi-Fi Protected Setup), Manual setup

Manuals and Their Contents

38CS-072

The manuals listed below are included with the machine. Refer to them as necessary.

Getting Started		<p>Read this manual first. It describes basic setup procedures, from removing the packing materials to setting up the machine.</p> 
User's Guide (This Manual)		<p>This manual describes all the functions of the machine in a manual that is viewed using a Web browser. You can browse information by category or enter a keyword to search for pages on a specific topic.  Using User's Guide(P. 333)</p>

Using User's Guide

38CS-073

The User's Guide is a manual that can be viewed on your computer or mobile device and it describes all of the functions of the machine. You can search from your intended use or enter a keyword to quickly find the page you are looking for. The section describes the screen layout of the User's Guide and how to read the Guide. You can specify how the appearance of the User's Guide looks.

■ Screen Layout of User's Guide

This section describes the screens configuring the User's Guide and how to use the on-screen buttons. [▶Screen Layout of User's Guide\(P. 334\)](#)

■ Viewing User's Guide

This section describes the meaning of the marks used in the User's Guide, how the keys on the operation panel and the buttons on the computer display are represented, and other matters that help you understand the information contained in the User's Guide. [▶Viewing User's Guide\(P. 337\)](#)

■ Specifying How the Appearance of the User's Guide Looks

You can change the character size used in the User's Guide, and switch the screen layout to fit to the device you use to view the User's Guide.

NOTE

- If you do not have access to Adobe Reader to view the manuals in PDF format, try other programs such as PDF Preview developed by Vivid Document Imaging Technologies.

How to Find the Topic You Are Looking for

Search the contents

- You can find the page you are looking for by selecting the topic from the "Contents" on the left side of the screen.

Search by keyword

- Perform a search by entering a keyword, such as "envelope" or "toner cartridge," and the pages containing the keyword are displayed. You can find the page you are looking for from those results. You can also enter phrases such as "connecting to a network." The keyword search also supports the AND Boolean to search for multiple keywords. For the organization of the search screen and how to operate the search screen, see [▶Search\(P. 336\)](#) .

Screen Layout of User's Guide



38CS-074

The User's Guide is divided into different screens, and the content of each screen varies.

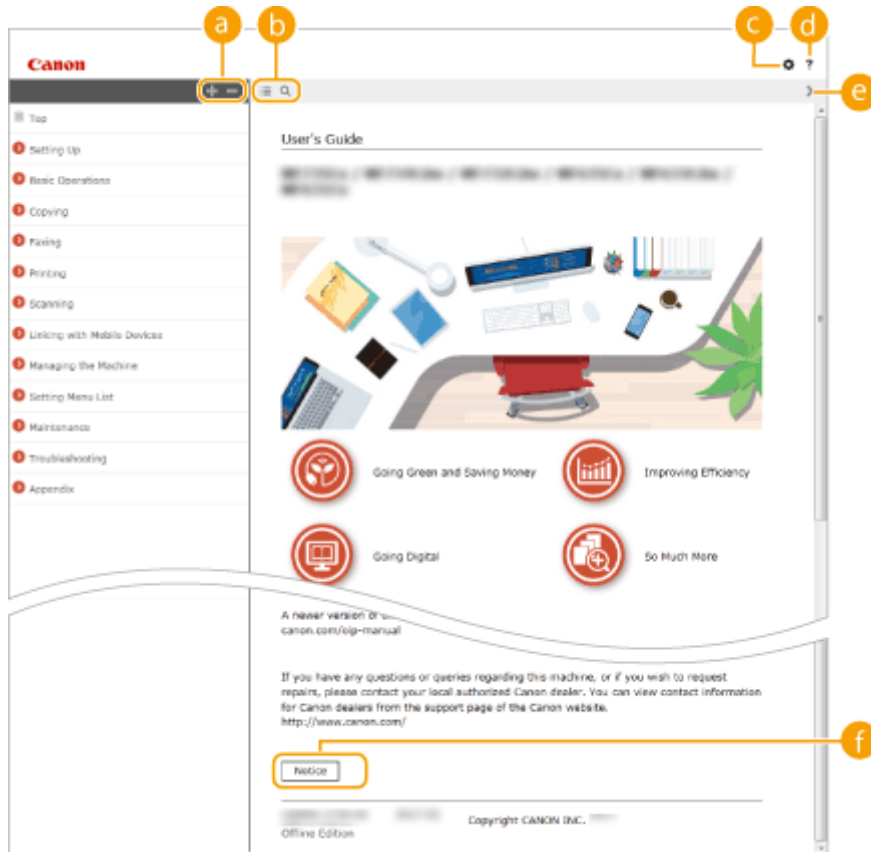

Top Page

Appears when User's Guide is started.



Click  to also display all of the sections under the chapters. Click  to return to the previous display.



Click to toggle the display between the contents and search. When the table of contents is displayed, each click on  switches between hiding and showing the display. When the search display is shown, each click on  switches between hiding and showing the display.



Click to set parameters to determine how the User's Guide is displayed, such as character size or layout.



Click to display information on how to view the User's Guide, how to perform a search, and other information.



Click to display the previous or following topic.



Click to view important information you should know when using the machine.

Topic Page

Contains information about how to configure and use the machine.

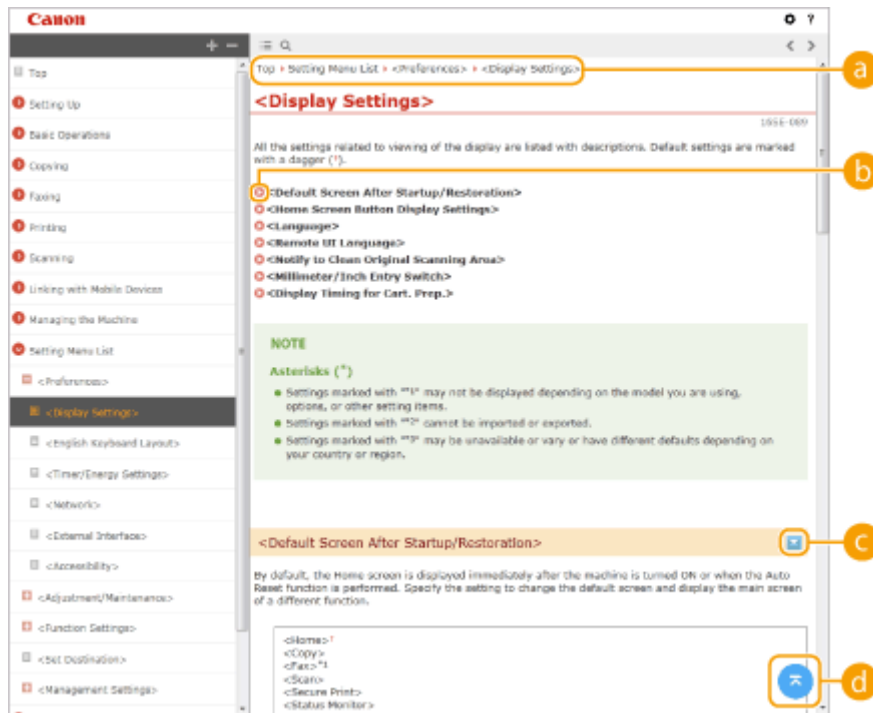

a Navigation

See what chapter topic you are currently viewing.

b



Click to jump to the corresponding page. To return to the previous page, click "Back" on your Web browser.

NOTE:

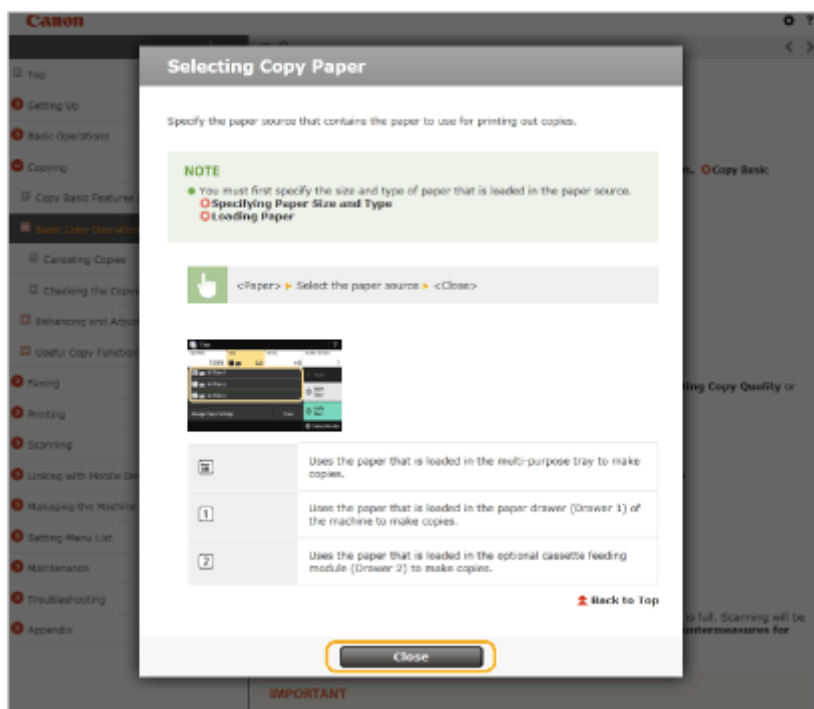
- When you click the icon, the current page may go dark and a pop-up window may appear. To return to the page, click [Close] in the pop-up window.





Click  to display the hidden detailed descriptions. Click  to close the detailed descriptions.



Click to return to the page top.

Search

Click  to display the search window. Contains a text box to perform a search by keyword and find the page you are looking for.

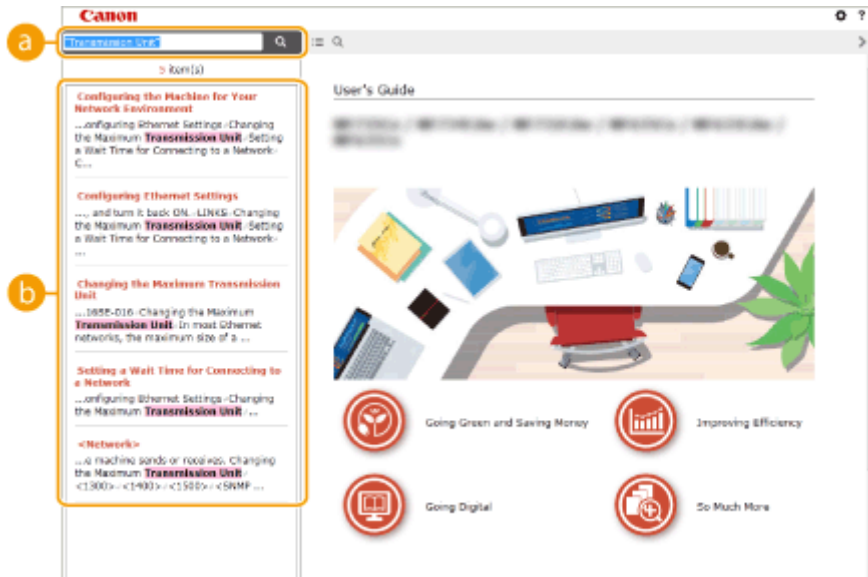

a [Enter keyword(s) here]

Enter a keyword or keywords and click  to display the search results. You can search for pages containing all the keywords by separating the keywords by a space (blank). Also you can only search for pages containing an exact phrase by enclosing the keywords in double quotation marks.

b Search result

Displays the search results of the pages that contain the specified keywords. From the results, locate the page you are looking for and click the topic title of the page.

NOTE:

- The specified keyword(s) are shown in bold in the search results.

Viewing User's Guide

38CS-075

This section describes the marks, buttons, screens, and other items used in the User's Guide. The warnings and cautions are also given in the "Important Safety Instructions" in the "Getting Started" included with the machine. See also these instructions.

Marks

Cautions regarding safety, restrictions and cautions regarding the handling of the machine, useful tips, and other information are indicated using the marks below.



Indicates an operation that must not be performed. Read these items carefully, and make sure not to perform the described operations.

IMPORTANT

Indicates operational requirements and restrictions. Be sure to read these items carefully to operate the machine correctly, and avoid damage to the machine or property.

NOTE

Indicates a clarification of an operation, or contains additional explanations for a procedure.

TIPS



Indicates useful functions or tips for using the machine.

Keys and Buttons Used in this Manual

Keys on the operation panel and buttons on the computer display appear in the following notation:

Type	Example
Keys on the operation panel	 ▲ / ▼ / ◀ / ▶
Settings displayed on the operation panel	<Timer Settings> <Paper jammed.>
Buttons and other text interfaces displayed on the computer display	[Preferences]



▲, ▼, and  on the operation panel are used to select the target item in settings, but their description is omitted in the User's Guide. The operation for selecting <XXXXX> using ▲ or ▼ and pressing  is represented as shown below in the User's Guide.

- 1 Select <XXXXX>.

Computer Screens Used in This Manual

Depending on the model or operating system you are using, the appearance of the displays used in this manual may slightly differ from the actual displays. Also, the appearance of drivers and software may differ depending on their version.

Basic Windows Operations

38CS-077

- ▶ **Displaying the Printer Folder(P. 338)**
- ▶ **Enabling [Network discovery](P. 338)**
- ▶ **Displaying Shared Printers in the Print Server(P. 339)**
- ▶ **Displaying the [Software Programs/Manuals Setup] Screen(P. 340)**
- ▶ **Printing a Test Page in Windows(P. 340)**
- ▶ **Checking the Bit Architecture(P. 341)**
- ▶ **Checking the Printer Port(P. 342)**
- ▶ **Checking Bidirectional Communication(P. 343)**
- ▶ **Checking the SSID to Which Your Computer is Connected(P. 344)**
- ▶ **When Printing from the Windows Store App(P. 345)**

NOTE

- Depending on the computer that you use, the operation may differ.

■ Displaying the Printer Folder

Windows Vista

[Start] ▶ select [Control Panel] ▶ [Printer].

Windows 7/Server 2008 R2

[Start] ▶ select [Devices and Printers].

Windows 8/Server 2012

Right-click the lower-left corner of the screen ▶ select [Control Panel] ▶ [View devices and printers].

Windows 8.1/Server 2012 R2

Right-click [Start] ▶ select [Control Panel] ▶ [View devices and printers].

Windows 10

[

Windows Server 2008

[Start] ▶ select [Control Panel] ▶ double-click [Printers].

Windows Server 2016

Right-click [

■ Enabling [Network discovery]

Enable [Network discovery] to view the computers on your network.

Windows Vista

[Start] ▶ select [Control Panel] ▶ [View network status and tasks] ▶ select [Turn on network discovery] under [Network discovery].

Windows 7/Server 2008 R2

[Start] ▶ select [Control Panel] ▶ [View network status and tasks] ▶ [Change advanced sharing settings] ▶ select [Turn on network discovery] under [Network discovery].

Windows 8/Server 2012

Right-click the lower-left corner of the screen ▶ select [Control Panel] ▶ [View network status and tasks] ▶ [Change advanced sharing settings] ▶ select [Turn on network discovery] under [Network discovery].

Windows 8.1/Server 2012 R2

Right-click [Start] ► select [Control Panel] ► [View network status and tasks] ► [Change advanced sharing settings] ► select [Turn on network discovery] under [Network discovery].

Windows 10

[] ► select [Windows System] ► [Control Panel] ► [View network status and tasks] ► [Change advanced sharing settings] ► select [Turn on network discovery] under [Network discovery].

Windows Server 2008

[Start] ► select [Control Panel] ► double-click [Network and Sharing Center] ► select [Turn on network discovery] under [Network discovery].

Windows Server 2016

Right-click [] ► select [Control Panel] ► [View network status and tasks] ► [Change advanced sharing settings] ► select [Turn on network discovery] under [Network discovery].

■ Displaying Shared Printers in the Print Server

1 Open Windows Explorer.

Windows Vista/7/Server 2008

[Start] ► select [All Programs] or [Programs] ► [Accessories] ► [Windows Explorer].

Windows 8/Server 2012

Right-click the lower-left corner of the screen ► select [File Explorer].

Windows 8.1/Server 2012 R2

Right-click [Start] ► select [File Explorer].

Windows 10/Server 2016

Right-click [] ► select [File Explorer].

2 Select the printer server in [Network] or [My Network Places].

- To view computers on the network, you may need to turn on network discovery or search the network for computers.

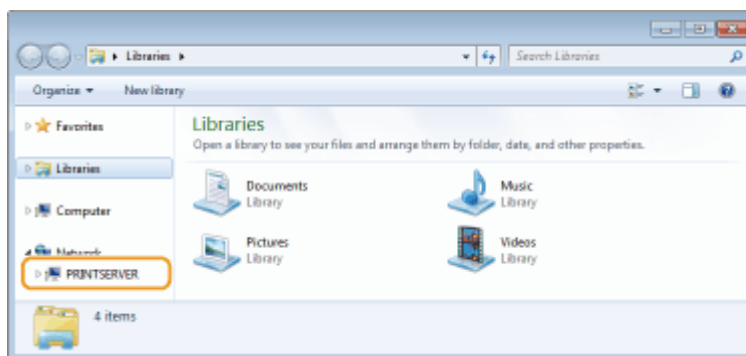

⇒ Shared printers are displayed.

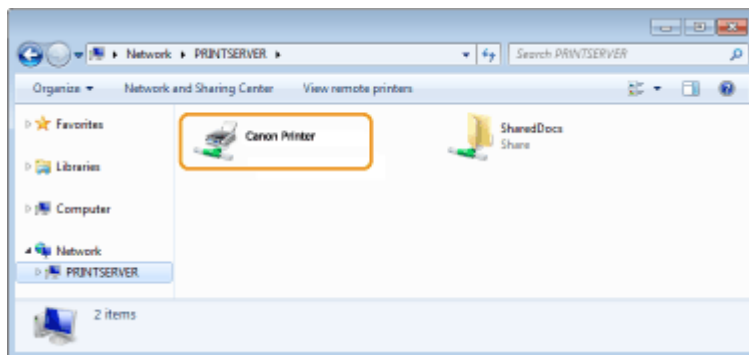

■ Displaying the [Software Programs/Manuals Setup] Screen

If your computer does not display the [Software Programs/Manuals Setup] screen after inserting the provided CD-ROM/DVD-ROM, follow the procedure below. The CD-ROM/DVD-ROM drive name is indicated as "D:" in this manual. The CD-ROM/DVD-ROM drive name may differ depending on the computer you are using.

Windows Vista/7/Server 2008

[Start] ► enter "D:\MInst.exe" in [Search programs and files] or [Start Search] ► press the [ENTER] key.

Windows 8/Server 2012

Right-click the lower-left corner of the screen ► [Run] ► Enter "D:\MInst.exe" ► click [OK]

Windows 8.1/Server 2012 R2

Right-click [Start] ► [Run] ► Enter "D:\MInst.exe" ► click [OK]

Windows 10

Enter "D:\MInst.exe" in the search box ► click [D:\MInst.exe] displayed as the search result.

Windows Server 2016

Click [🔍] ► enter "D:\MInst.exe" ► click [D:\MInst.exe] displayed as the search result.

■ Printing a Test Page in Windows

You can check whether the printer driver is operational by printing a test page in Windows.

- 1 Load A4 size paper in the drawer. ▶ Loading Paper in the Drawer(P. 88)**
- 2 Open the printer folder. ▶ Displaying the Printer Folder(P. 338)**
- 3 Right-click the printer driver icon for this machine, and click [Printer properties] or [Properties].**

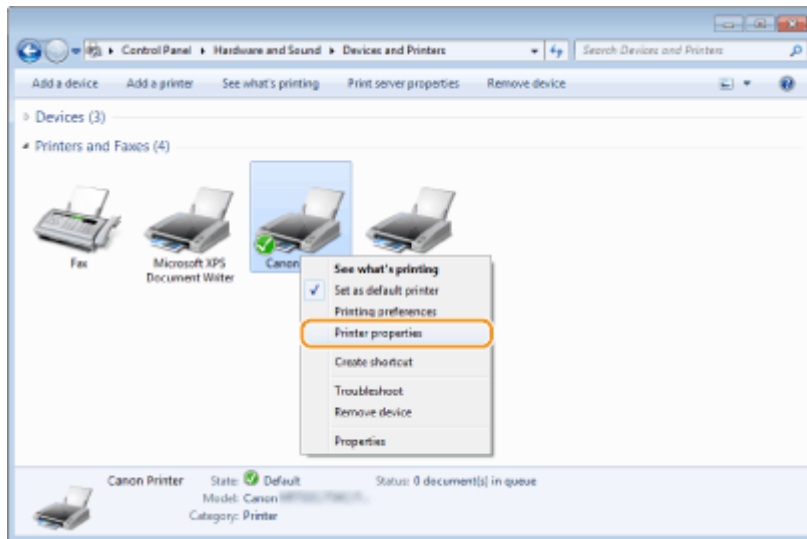

4 Click [Print Test Page] in [General] tab.

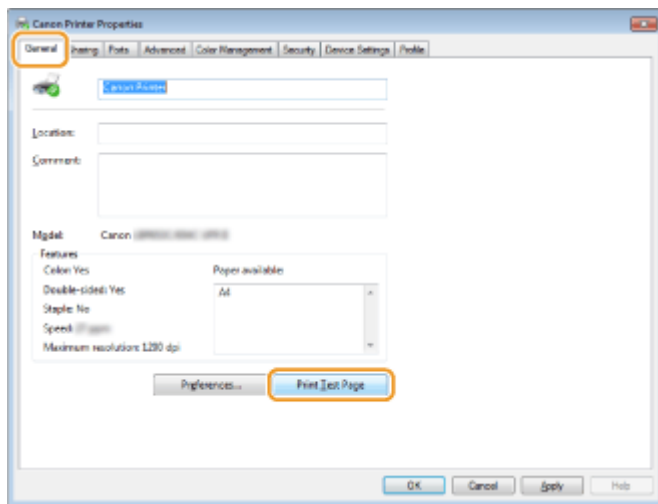

⇒ The test page is printed.

■ Checking the Bit Architecture

If you are not sure whether your computer is running 32-bit or 64-bit Windows follow the procedure below.

1 Display [Control Panel].

Windows Vista/7/Server 2008
[Start] ► select [Control Panel].

Windows 8/Server 2012
Right-click the lower-left corner of the screen ► select [Control Panel].

Windows 8.1/Server 2012 R2
Right-click [Start] ► select [Control Panel].

Windows 10/Server 2016
Proceed to step 2.

2 Display [System].

Windows Vista/7/8/Server 2008 R2/Server 2012

Click [System and Maintenance] or [System and Security] ► [System].

Windows 10/Server 2016

Click [Start] ► [Settings] ► [System] ► select [About].

Windows Server 2008

Double-click [System].

3 Check the bit architecture.**For 32-bit versions**

[32-bit Operating System] is displayed.

For 64-bit versions

[64-bit Operating System] is displayed.

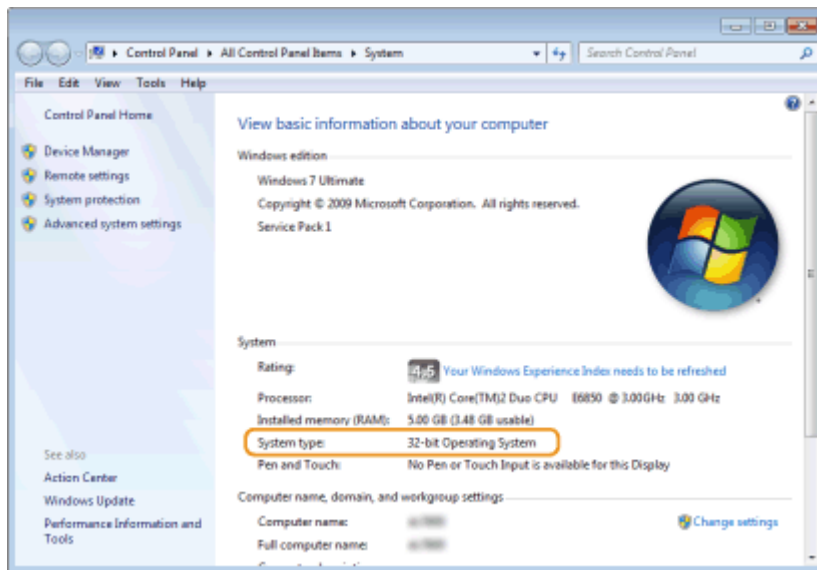
**■ Checking the Printer Port**

1 Open the printer folder. ► **Displaying the Printer Folder(P. 338)**

2 Right-click the printer driver icon for this machine, and click [Printer properties] or [Properties].

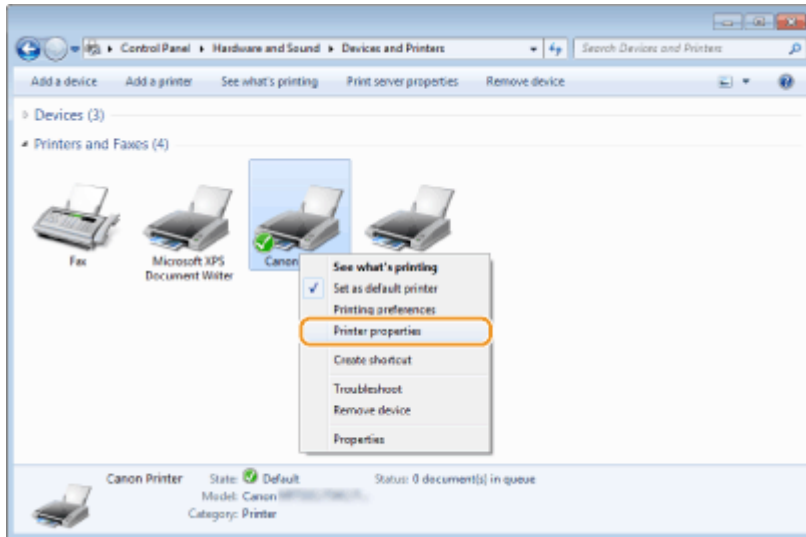

3 In the [Ports] tab, check that the port is selected correctly.

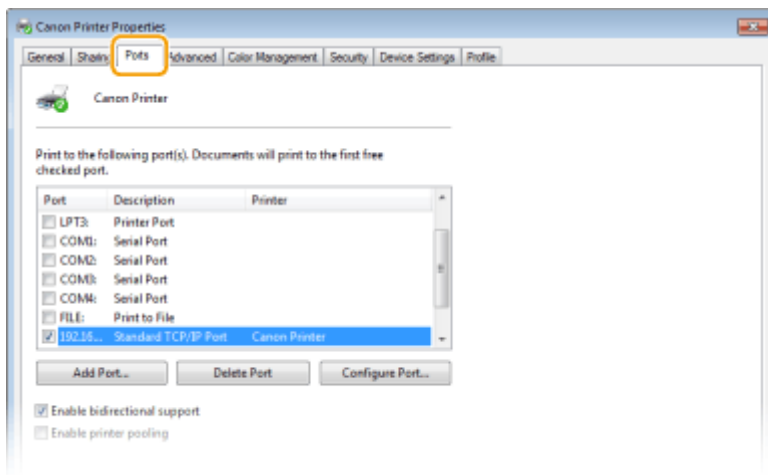

NOTE

If you are using a network connection and have changed the machine's IP address

- If [Description] for the selected port is [Canon MFNP Port], and the machine and the computer are on the same subnet, then the connection will be maintained. You do not need to add a new port. If it is [Standard TCP/IP Port], you need to add a new port. ▶ **Configuring Printer Ports(P. 39)**

■ Checking Bidirectional Communication

1 Open the printer folder. ▶ **Displaying the Printer Folder(P. 338)**

2 Right-click the printer driver icon for this machine, and click [Printer properties] or [Properties].

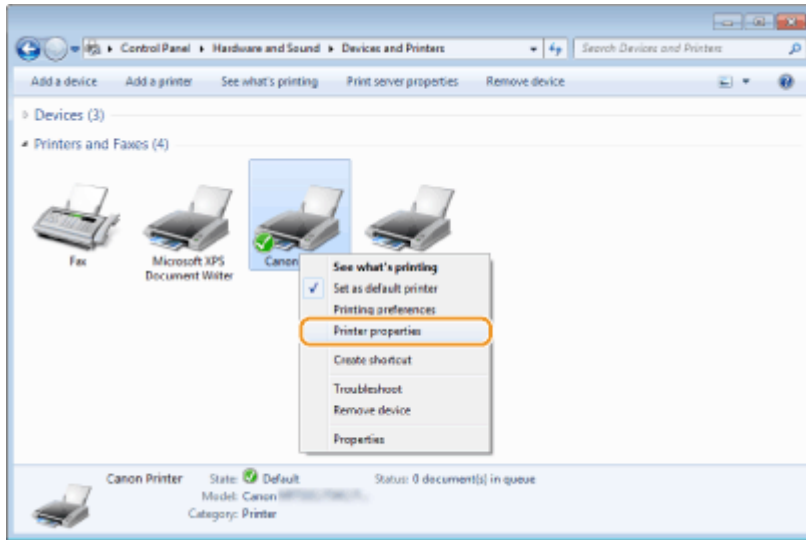

3 In the [Ports] tab, make sure that the [Enable bidirectional support] check box is selected.

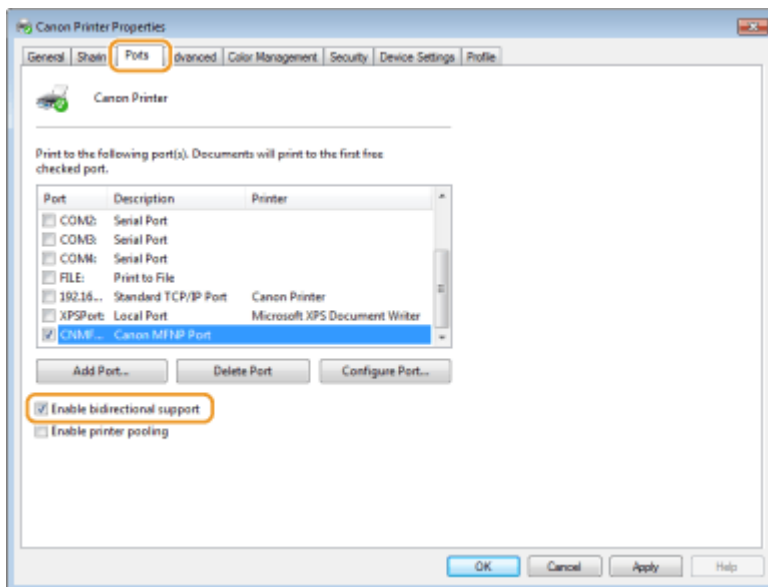

■ Checking the SSID to Which Your Computer is Connected

If your computer is connected to a wireless LAN network, click , , or in the system tray to display the SSID of the connected wireless LAN router.

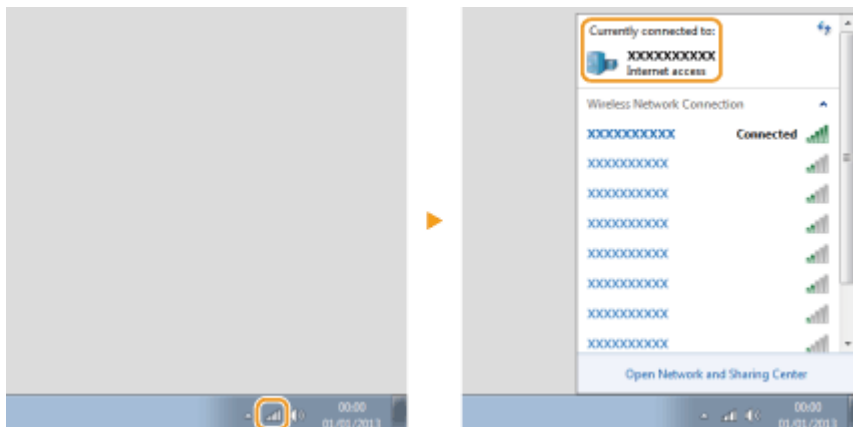

■ When Printing from the Windows Store App

Windows Server 2012

Display the charms on the right side of the screen ► Tap or click [Devices] ► The driver that you use ► [Print].

Windows 8.1/Server 2012 R2

Display the charms on the right side of the screen ► Tap or click [Devices] ► [Print] ► The driver that you use ► [Print].

Windows 10

Tap or click [Print] on the application ► The driver that you use ► [Print].

NOTE

- If you print using this method, only a limited number of print settings are available.
- If the message [The printer requires your attention. Go to the desktop to take care of it.] is displayed, go to the desktop and follow the instructions in the displayed dialog box. This message appears when the machine is set to display the user name during printing and similar instances.

Notice

38CS-078

■ IPv6 Ready Logo



The protocol stack included in this machine has obtained the IPv6 Ready Logo Phase-1 established by the IPv6 Forum.

■ E-Waste Rules

India only

This product is not to be disposed of with your household waste, according to the E-Waste (Management) Rules, 2016. This product should be handed over to a designated collection point, e.g., to an authorized collection site for recycling waste electrical and electronic equipment (EEE). Improper handling of this type of waste could have a possible negative impact on the environment and human health due to potentially hazardous substances that are generally associated with EEE. At the same time, your cooperation in the correct disposal of this product will contribute to the effective usage of natural resources. For more information regarding return and recycling of WEEE products, please visit <http://www.canon.co.in/environment> or write to us at customer.delight@canon.co.in.

Also, this product complies with the "E-Waste (Management) Rules, 2016" and prohibits use of lead, mercury, hexavalent chromium, polybrominated biphenyls or polybrominated diphenyl ethers in concentrations exceeding 0.1 % by weight and 0.01 % by weight for Cadmium, except for the exemptions set in Schedule II of the Rule.



■ Disclaimers

- The information in this document is subject to change without notice.
- CANON INC. MAKES NO WARRANTY OF ANY KIND WITH REGARD TO THIS MATERIAL, EITHER EXPRESS OR IMPLIED, EXCEPT AS PROVIDED HEREIN, INCLUDING WITHOUT LIMITATION, THEREOF, WARRANTIES AS TO MARKETABILITY, MERCHANTABILITY, FITNESS FOR A PARTICULAR PURPOSE OF USE, OR NON-INFRINGEMENT. CANON INC. SHALL NOT BE LIABLE FOR ANY DIRECT, INCIDENTAL, OR CONSEQUENTIAL DAMAGES OF ANY NATURE, OR LOSSES OR EXPENSES RESULTING FROM THE USE OF THIS MATERIAL.

■ Trademarks

Adobe, Acrobat, and Reader are registered trademarks of Adobe Systems Incorporated in the United States and/or other countries.

Apple, Bonjour, iPad, iPhone, iPod touch, Mac, macOS, OS X and Safari are trademarks of Apple Inc.

Microsoft, Windows, Windows Vista, Windows Server, Internet Explorer, Word and Excel are either registered trademarks or trademarks of Microsoft Corporation in the United States and/or other countries.

iOS is a trademark or registered trademark of Cisco in the U.S. and other countries and is used under license.

Google Cloud Print, Google Chrome and Android are either registered trademarks or trademarks of Google Inc. Mopria®, the Mopria® Logo and the Mopria® Alliance logo are registered trademarks and service marks of Mopria Alliance, Inc. in the United States and other countries. Unauthorized use is strictly prohibited.



The Adobe PDF logo is a trademark or registered trademark of Adobe Systems Incorporated in the United States and other countries.

Copyright © 2008 Adobe Systems Incorporated. All rights reserved.

Protected by U.S. Patents 6,185,684; 6,205,549; 7,213,269; 7,272,628; 7,278,168; Patents pending in the U.S. and other countries.

All instances of the name PostScript in the text are references to the PostScript language as defined by Adobe Systems Incorporated unless otherwise stated. The name PostScript also is used as a product trademark for Adobe Systems' implementation of the PostScript language interpreter.

Except as otherwise stated, any reference to a "PostScript printing device," "PostScript display device," or similar item refers to a printing device, display device or item (respectively) that contains PostScript technology created or licensed by Adobe Systems Incorporated and not to devices or items that purport to be merely compatible with the PostScript language.

Adobe, the Adobe logo, Adobe LiveCycle® Policy Server, InDesign, PostScript, the PostScript Logo, and PostScript 3 are either registered trademarks or trademarks of Adobe Systems Incorporated in the United States and/or other countries.

All other trademarks are the property of their respective owners.

Portions of this software are copyright © 2007 The FreeType Project (www.freetype.org). All rights reserved.

All other product and brand names are registered trademarks, trademarks or service marks of their respective owners.

■ Copyright

Reproduction of the contents of this document in whole or in part without prior permission is prohibited.

V_180228

This Font Software is licensed under the SIL Open Font License, Version 1.1.

This license is copied below, and is also available with a FAQ at: <http://scripts.sil.org/OFL>

SIL OPEN FONT LICENSE Version 1.1 - 26 February 2007

PREAMBLE

The goals of the Open Font License (OFL) are to stimulate worldwide development of collaborative font projects, to support the font creation efforts of academic and linguistic communities, and to provide a free and open framework in which fonts may be shared and improved in partnership with others.

The OFL allows the licensed fonts to be used, studied, modified and redistributed freely as long as they are not sold by themselves. The fonts, including any derivative works, can be bundled, embedded, redistributed and/or sold with any software provided that any reserved names are not used by derivative works. The fonts and derivatives, however, cannot be released under any other type of license. The requirement for fonts to remain under this license does not apply to any document created using the fonts or their derivatives.

DEFINITIONS

"Font Software" refers to the set of files released by the Copyright Holder(s) under this license and clearly marked as such. This may include source files, build scripts and documentation.

"Reserved Font Name" refers to any names specified as such after the copyright statement(s).

"Original Version" refers to the collection of Font Software components as distributed by the Copyright Holder(s).

"Modified Version" refers to any derivative made by adding to, deleting, or substituting -- in part or in whole -- any of the components of the Original Version, by changing formats or by porting the Font Software to a new environment.

"Author" refers to any designer, engineer, programmer, technical writer or other person who contributed to the Font Software.

PERMISSION & CONDITIONS

Permission is hereby granted, free of charge, to any person obtaining a copy of the Font Software, to use, study, copy, merge, embed, modify, redistribute, and sell modified and unmodified copies of the Font Software, subject to the following conditions:

- 1) Neither the Font Software nor any of its individual components, in Original or Modified Versions, may be sold by itself.
- 2) Original or Modified Versions of the Font Software may be bundled, redistributed and/or sold with any software, provided that each copy contains the above copyright notice and this license. These can be included either as stand-alone text files, human-readable headers or in the appropriate machine-readable metadata fields within text or binary files as long as those fields can be easily viewed by the user.
- 3) No Modified Version of the Font Software may use the Reserved Font Name(s) unless explicit written permission is granted by the corresponding Copyright Holder. This restriction only applies to the primary font name as presented to the users.
- 4) The name(s) of the Copyright Holder(s) or the Author(s) of the Font Software shall not be used to promote, endorse or advertise any Modified Version, except to acknowledge the contribution(s) of the Copyright Holder(s) and the Author(s) or with their explicit written permission.
- 5) The Font Software, modified or unmodified, in part or in whole, must be distributed entirely under this license, and must not be distributed under any other license. The requirement for fonts to remain under this license does not apply to any document created using the Font Software.

TERMINATION

This license becomes null and void if any of the above conditions are not met.

DISCLAIMER

THE FONT SOFTWARE IS PROVIDED "AS IS", WITHOUT WARRANTY OF ANY KIND, EXPRESS OR IMPLIED, INCLUDING BUT NOT LIMITED TO ANY WARRANTIES OF MERCHANTABILITY, FITNESS FOR A PARTICULAR PURPOSE AND NONINFRINGEMENT OF COPYRIGHT, PATENT, TRADEMARK, OR OTHER RIGHT. IN NO EVENT SHALL THE COPYRIGHT HOLDER BE LIABLE FOR ANY CLAIM, DAMAGES OR OTHER LIABILITY, INCLUDING ANY GENERAL, SPECIAL, INDIRECT, INCIDENTAL, OR CONSEQUENTIAL DAMAGES, WHETHER IN AN ACTION OF CONTRACT, TORT OR OTHERWISE, ARISING FROM, OUT OF THE USE OR INABILITY TO USE THE FONT SOFTWARE OR FROM OTHER DEALINGS IN THE FONT SOFTWARE.

The Software Subjected to the Other License Conditions

Please refer to Table of Software and respective License terms below, for more detail and corresponding license conditions.

Table of Software

Names of Software	Terms and Conditions of the License: See Page
Adobe PDF Scan Library	2
bldimake	5
FreeType	6
snmp	11
Incl	14
JPEG	15
math	16
mDNSResponder	17
mDNSResponder (part of mDNSShared)	21
OpenSSL	22
xpm	26

Portions use software under the following terms:

This product contains either BSAFE and/or TIPEM software by RSA Security Inc.

This product includes software developed by the Apache Software Foundation (<http://www.apache.org/>).
Copyright (c) 1998-2000 The Apache Software Foundation. All rights reserved.

Redistribution and use in source and binary forms, with or without modification, are permitted provided that the following conditions are met:

1. Redistributions of source code must retain the above copyright notice, this list of conditions and the following disclaimer.
2. Redistributions in binary form must reproduce the above copyright notice, this list of conditions and the following disclaimer in the documentation and/or other materials provided with the distribution.
3. The end-user documentation included with the redistribution, if any, must include the following acknowledgment:

"This product includes software developed by the Apache Software Foundation (<http://www.apache.org/>)."

Alternately, this acknowledgment may appear in the software itself, if and wherever such third-party acknowledgments normally appear.

4. The names "Xerces" and "Apache Software Foundation" must not be used to endorse or promote products derived from this software without prior written permission. For written permission, please contact apache@apache.org.
5. Products derived from this software may not be called "Apache", nor may "Apache" appear in their name, without prior written permission of the Apache Software Foundation.

THIS SOFTWARE IS PROVIDED ``AS IS" AND ANY EXPRESSED OR IMPLIED WARRANTIES, INCLUDING, BUT NOT LIMITED TO, THE IMPLIED WARRANTIES OF MERCHANTABILITY AND FITNESS FOR A PARTICULAR PURPOSE ARE DISCLAIMED. IN NO EVENT SHALL THE APACHE SOFTWARE FOUNDATION OR ITS CONTRIBUTORS BE LIABLE FOR ANY DIRECT, INDIRECT, INCIDENTAL, SPECIAL, EXEMPLARY, OR CONSEQUENTIAL DAMAGES (INCLUDING, BUT NOT LIMITED TO, PROCUREMENT OF SUBSTITUTE GOODS OR SERVICES; LOSS OF USE, DATA, OR PROFITS; OR BUSINESS INTERRUPTION) HOWEVER CAUSED AND ON ANY THEORY OF LIABILITY, WHETHER IN CONTRACT, STRICT LIABILITY, OR TORT (INCLUDING NEGLIGENCE OR OTHERWISE) ARISING IN ANY WAY OUT OF THE USE OF THIS SOFTWARE, EVEN IF ADVISED OF THE POSSIBILITY OF SUCH DAMAGE.

This software consists of voluntary contributions made by many individuals on behalf of the Apache Software Foundation and was originally based on software copyright (c) 1999, International Business Machines, Inc., <http://www.ibm.com>. For more information on the Apache Software Foundation, please see <http://www.apache.org/>.

March 27, 2003

Portions of this product are based on Modifications created from the Original Code known as the "Sablotron XSLT Processor". The Sablotron XSLT Processor is subject to the Mozilla Public License Version 1.1 (the "License"). You may obtain a copy of the License at <http://www.mozilla.org/MPL/>

Software distributed under the License is distributed on an "AS IS" basis, WITHOUT WARRANTY OF ANY KIND, either express or implied. See the License for the specific language governing rights and limitations under the License.

The Original Code is the Sablotron XSLT Processor.

The Initial Developer of the Original Code is Ginger Alliance Ltd. Portions created by Ginger Alliance are Copyright (C) 2000 Ginger Alliance Ltd. All Rights Reserved.

Pursuant to sections 3.2 and 3.6 of the License, the Modifications created by Adobe Systems Incorporated are available as Source Code. The Modifications may be downloaded via the Internet from:

<http://partners.adobe.com/asn/tech/xml/sablotron/index.jsp>

The Original Code may be downloaded via the Internet from:

<https://sourceforge.net/projects/sablotron/>

Portions Copyright (c) 1997-1999 Silicon Graphics Computer Systems, Inc.

Permission to use, copy, modify, distribute and sell this software and its documentation for any purpose is hereby granted without fee, provided that the above copyright notice appear in all copies and that both that copyright notice and this permission notice appear in supporting documentation. Silicon Graphics makes no representations about the suitability of this software for any purpose. It is provided "as is" without express or implied warranty.

The Loki Library

Portions Copyright (c) 2001 by Andrei Alexandrescu . This code accompanies the book: Alexandrescu, Andrei. "Modern C++ Design: Generic Programming and Design Patterns Applied".

Portions Copyright (c) 2001. Addison-Wesley. Permission to use, copy, modify, distribute and sell this software for any purpose is hereby granted without fee, provided that the above copyright notice appear in all copies and that both that copyright notice and this permission notice appear in supporting documentation. The author or Addison-Wesley Longman make no representations about the suitability of this software for any purpose. It is provided "as is" without express or implied warranty.

Updated Information/Additional Third Party Code Information available at <http://www.adobe.com/go/thirdparty> .

bldimake

Copyright (c) 1985, 1986, 1987, 1988 The Open Group

All right Reserved.

Permission to use, copy, modify, distribute, and sell this software and its documentation for any purpose is hereby granted without fee, provided that the above copyright notice appear in all copies and that both that copyright notice and this permission notice appear in supporting documentation. The above copyright notice and this permission notice shall be included in all copies or substantial portions of the Software.

THE SOFTWARE IS PROVIDED "AS IS", WITHOUT WARRANTY OF ANY KIND, EXPRESS OR IMPLIED, INCLUDING BUT NOT LIMITED TO THE WARRANTIES OF MERCHANTABILITY, FITNESS FOR A PARTICULAR PURPOSE AND NONINFRINGEMENT. IN NO EVENT SHALL THE OPEN GROUP BE LIABLE FOR ANY CLAIM, DAMAGES OR OTHER LIABILITY, WHETHER IN AN ACTION OF CONTRACT, TORT OR OTHERWISE, ARISING FROM, OUT OF OR IN CONNECTION WITH THE SOFTWARE OR THE USE OR OTHER DEALINGS IN THE SOFTWARE.

Except as contained in this notice, the name of The Open Group shall not be used in advertising or otherwise to promote the sale, use or other dealings in this Software without prior written authorization from The Open Group.

FreeType

The FreeType Project LICENSE

2006-Jan-27

Copyright 1996-2002, 2006 by
David Turner, Robert Wilhelm, and Werner Lemberg

Introduction

=====

The FreeType Project is distributed in several archive packages; some of them may contain, in addition to the FreeType font engine, various tools and contributions which rely on, or relate to, the FreeType Project.

This license applies to all files found in such packages, and which do not fall under their own explicit license. The license affects thus the FreeType font engine, the test programs, documentation and makefiles, at the very least.

This license was inspired by the BSD, Artistic, and IJG (Independent JPEG Group) licenses, which all encourage inclusion and use of free software in commercial and freeware products alike. As a consequence, its main points are that:

- o We don't promise that this software works. However, we will be interested in any kind of bug reports. ('as is' distribution)
- o You can use this software for whatever you want, in parts or full form, without having to pay us. ('royalty-free' usage)
- o You may not pretend that you wrote this software. If you use it, or only parts of it, in a program, you must acknowledge

somewhere in your documentation that you have used the FreeType code. ('credits')

We specifically permit and encourage the inclusion of this software, with or without modifications, in commercial products. We disclaim all warranties covering The FreeType Project and assume no liability related to The FreeType Project.

Finally, many people asked us for a preferred form for a credit/disclaimer to use in compliance with this license. We thus encourage you to use the following text:

Portions of this software are copyright © <year> The FreeType Project (www.freetype.org). All rights reserved.

Please replace <year> with the value from the FreeType version you actually use.

Legal Terms

=====

0. Definitions

Throughout this license, the terms 'package', 'FreeType Project', and 'FreeType archive' refer to the set of files originally distributed by the authors (David Turner, Robert Wilhelm, and Werner Lemberg) as the 'FreeType Project', be they named as alpha, beta or final release.

'You' refers to the licensee, or person using the project, where 'using' is a generic term including compiling the project's source code as well as linking it to form a 'program' or 'executable'. This program is referred to as 'a program using the FreeType

engine'.

This license applies to all files distributed in the original FreeType Project, including all source code, binaries and documentation, unless otherwise stated in the file in its original, unmodified form as distributed in the original archive. If you are unsure whether or not a particular file is covered by this license, you must contact us to verify this.

The FreeType Project is copyright (C) 1996-2000 by David Turner, Robert Wilhelm, and Werner Lemberg. All rights reserved except as specified below.

1. No Warranty

THE FREETYPE PROJECT IS PROVIDED 'AS IS' WITHOUT WARRANTY OF ANY KIND, EITHER EXPRESS OR IMPLIED, INCLUDING, BUT NOT LIMITED TO, WARRANTIES OF MERCHANTABILITY AND FITNESS FOR A PARTICULAR PURPOSE. IN NO EVENT WILL ANY OF THE AUTHORS OR COPYRIGHT HOLDERS BE LIABLE FOR ANY DAMAGES CAUSED BY THE USE OR THE INABILITY TO USE, OF THE FREETYPE PROJECT.

2. Redistribution

This license grants a worldwide, royalty-free, perpetual and irrevocable right and license to use, execute, perform, compile, display, copy, create derivative works of, distribute and sublicense the FreeType Project (in both source and object code forms) and derivative works thereof for any purpose; and to authorize others to exercise some or all of the rights granted herein, subject to the following conditions:

- o Redistribution of source code must retain this license file ('FTL.TXT') unaltered; any additions, deletions or changes to the original files must be clearly indicated in accompanying documentation. The copyright notices of the unaltered,

original files must be preserved in all copies of source files.

- o Redistribution in binary form must provide a disclaimer that states that the software is based in part of the work of the FreeType Team, in the distribution documentation. We also encourage you to put an URL to the FreeType web page in your documentation, though this isn't mandatory.

These conditions apply to any software derived from or based on the FreeType Project, not just the unmodified files. If you use our work, you must acknowledge us. However, no fee need be paid to us.

3. Advertising

Neither the FreeType authors and contributors nor you shall use the name of the other for commercial, advertising, or promotional purposes without specific prior written permission.

We suggest, but do not require, that you use one or more of the following phrases to refer to this software in your documentation or advertising materials: 'FreeType Project', 'FreeType Engine', 'FreeType library', or 'FreeType Distribution'.

As you have not signed this license, you are not required to accept it. However, as the FreeType Project is copyrighted material, only this license, or another one contracted with the authors, grants you the right to use, distribute, and modify it. Therefore, by using, distributing, or modifying the FreeType Project, you indicate that you understand and accept all the terms of this license.

4. Contacts

There are two mailing lists related to FreeType:

o freetype@nongnu.org

Discusses general use and applications of FreeType, as well as future and wanted additions to the library and distribution.

If you are looking for support, start in this list if you haven't found anything to help you in the documentation.

o freetype-devel@nongnu.org

Discusses bugs, as well as engine internals, design issues, specific licenses, porting, etc.

Our home page can be found at

<http://www.freetype.org>

--- end of FTL.TXT ---

snmp

Copyright 1988, 1989 by Carnegie Mellon University

All Rights Reserved

Permission to use, copy, modify, and distribute this software and its documentation for any purpose and without fee is hereby granted, provided that the above copyright notice appear in all copies and that both that copyright notice and this permission notice appear in supporting documentation, and that the name of CMU not be used in advertising or publicity pertaining to distribution of the software without specific, written prior permission.

CMU DISCLAIMS ALL WARRANTIES WITH REGARD TO THIS SOFTWARE, INCLUDING ALL IMPLIED WARRANTIES OF MERCHANTABILITY AND FITNESS, IN NO EVENT SHALL CMU BE LIABLE FOR ANY SPECIAL, INDIRECT OR CONSEQUENTIAL DAMAGES OR ANY DAMAGES WHATSOEVER RESULTING FROM LOSS OF USE, DATA OR PROFITS, WHETHER IN AN ACTION OF CONTRACT, NEGLIGENCE OR OTHER TORTIOUS ACTION, ARISING OUT OF OR IN CONNECTION WITH THE USE OR PERFORMANCE OF THIS SOFTWARE.

/* Copyright (C) 1995-1998 Eric Young (eay@cryptsoft.com)

* All rights reserved.

*

* This package is an SSL implementation written

* by Eric Young (eay@cryptsoft.com).

* The implementation was written so as to conform with Netscapes SSL.

*

* This library is free for commercial and non-commercial use as long as

* the following conditions are aheared to. The following conditions

* apply to all code found in this distribution, be it the RC4, RSA,

* lhash, DES, etc., code; not just the SSL code. The SSL documentation

* included with this distribution is covered by the same copyright terms

* except that the holder is Tim Hudson (tjh@cryptsoft.com).

*

* Copyright remains Eric Young's, and as such any Copyright notices in

- * the code are not to be removed.
- * If this package is used in a product, Eric Young should be given attribution
- * as the author of the parts of the library used.
- * This can be in the form of a textual message at program startup or
- * in documentation (online or textual) provided with the package.
- *
- * Redistribution and use in source and binary forms, with or without
- * modification, are permitted provided that the following conditions
- * are met:
- * 1. Redistributions of source code must retain the copyright
- * notice, this list of conditions and the following disclaimer.
- * 2. Redistributions in binary form must reproduce the above copyright
- * notice, this list of conditions and the following disclaimer in the
- * documentation and/or other materials provided with the distribution.
- * 3. All advertising materials mentioning features or use of this software
- * must display the following acknowledgement:
- * "This product includes cryptographic software written by
- * Eric Young (eay@cryptsoft.com)"
- * The word 'cryptographic' can be left out if the rouines from the library
- * being used are not cryptographic related :-).
- * 4. If you include any Windows specific code (or a derivative thereof) from
- * the apps directory (application code) you must include an acknowledgement:
- * "This product includes software written by Tim Hudson (tjh@cryptsoft.com)"
- *
- * THIS SOFTWARE IS PROVIDED BY ERIC YOUNG ``AS IS" AND
- * ANY EXPRESS OR IMPLIED WARRANTIES, INCLUDING, BUT NOT LIMITED TO, THE
- * IMPLIED WARRANTIES OF MERCHANTABILITY AND FITNESS FOR A PARTICULAR PURPOSE
- * ARE DISCLAIMED. IN NO EVENT SHALL THE AUTHOR OR CONTRIBUTORS BE LIABLE
- * FOR ANY DIRECT, INDIRECT, INCIDENTAL, SPECIAL, EXEMPLARY, OR CONSEQUENTIAL
- * DAMAGES (INCLUDING, BUT NOT LIMITED TO, PROCUREMENT OF SUBSTITUTE GOODS
- * OR SERVICES; LOSS OF USE, DATA, OR PROFITS; OR BUSINESS INTERRUPTION)
- * HOWEVER CAUSED AND ON ANY THEORY OF LIABILITY, WHETHER IN CONTRACT, STRICT
- * LIABILITY, OR TORT (INCLUDING NEGLIGENCE OR OTHERWISE) ARISING IN ANY WAY
- * OUT OF THE USE OF THIS SOFTWARE, EVEN IF ADVISED OF THE POSSIBILITY OF
- * SUCH DAMAGE.
- *
- * The licence and distribution terms for any publically available version or
- * derivative of this code cannot be changed. i.e. this code cannot simply be

* copied and put under another distribution licence

* [including the GNU Public Licence.]

*/

Copyright 1988, 1989 by Carnegie Mellon University

Copyright 1989 TGV, Incorporated

All Rights Reserved

Permission to use, copy, modify, and distribute this software and its documentation for any purpose and without fee is hereby granted, provided that the above copyright notice appear in all copies and that both that copyright notice and this permission notice appear in supporting documentation, and that the name of CMU and TGV not be used in advertising or publicity pertaining to distribution of the software without specific, written prior permission.

CMU AND TGV DISCLAIMS ALL WARRANTIES WITH REGARD TO THIS SOFTWARE, INCLUDING ALL IMPLIED WARRANTIES OF MERCHANTABILITY AND FITNESS, IN NO EVENT SHALL CMU OR TGV BE LIABLE FOR ANY SPECIAL, INDIRECT OR CONSEQUENTIAL DAMAGES OR ANY DAMAGES WHATSOEVER RESULTING FROM LOSS OF USE, DATA OR PROFITS, WHETHER IN AN ACTION OF CONTRACT, NEGLIGENCE OR OTHER TORTIOUS ACTION, ARISING OUT OF OR IN CONNECTION WITH THE USE OR PERFORMANCE OF THIS SOFTWARE.

Incl

Copyright (c) 1994-96 SunSoft, Inc.

Permission is hereby granted, free of charge, to any person obtaining a copy of this software and associated documentation files (the "Software"), to deal in the Software without restriction, including without limitation the rights to use, copy, modify, merge, publish, distribute, sublicense, and/or sell copies of the Software, and to permit persons to whom the Software is furnished to do so, subject to the following conditions:

The above copyright notice and this permission notice shall be included in all copies or substantial portions of the Software.

THE SOFTWARE IS PROVIDED "AS IS", WITHOUT WARRANTY OF ANY KIND, EXPRESS OR IMPLIED, INCLUDING BUT NOT LIMITED TO THE WARRANTIES OF MERCHANTABILITY, FITNESS FOR A PARTICULAR PURPOSE AND NONINFRINGEMENT. IN NO EVENT SHALL SUNSOFT INC. OR ITS PARENT COMPANY BE LIABLE FOR ANY CLAIM, DAMAGES OR OTHER LIABILITY, WHETHER IN AN ACTION OF CONTRACT, TORT OR OTHERWISE, ARISING FROM, OUT OF OR IN CONNECTION WITH THE SOFTWARE OR THE USE OR OTHER DEALINGS IN THE SOFTWARE.

Except as contained in this notice, the name of SunSoft, Inc. shall not be used in advertising or otherwise to promote the sale, use or other dealings in this Software without prior written authorization from SunSoft, Inc.

JPEG

"this software is based in part on the work of the Independent JPEG Group."

math

Copyright (c) 1993 by Sun Microsystems, Inc. All rights reserved.

Developed at SunPro, a Sun Microsystems, Inc. business.

Permission to use, copy, modify, and distribute this software is freely granted, provided that this notice is preserved.

copysignf.c:* Copyright (c) 1993 by Sun Microsystems, Inc. All rights reserved.

math_private.h:* Copyright (c) 1993 by Sun Microsystems, Inc. All rights reserved.

powf.c:* Copyright (c) 1993 by Sun Microsystems, Inc. All rights reserved.

scalbnf.c:* Copyright (c) 1993 by Sun Microsystems, Inc. All rights reserved.

Apache License

Version 2.0, January 2004

<http://www.apache.org/licenses/>

TERMS AND CONDITIONS FOR USE, REPRODUCTION, AND DISTRIBUTION

1. Definitions.

"License" shall mean the terms and conditions for use, reproduction, and distribution as defined by Sections 1 through 9 of this document.

"Licensor" shall mean the copyright owner or entity authorized by the copyright owner that is granting the License.

"Legal Entity" shall mean the union of the acting entity and all other entities that control, are controlled by, or are under common control with that entity. For the purposes of this definition, "control" means (i) the power, direct or indirect, to cause the direction or management of such entity, whether by contract or otherwise, or (ii) ownership of fifty percent (50%) or more of the outstanding shares, or (iii) beneficial ownership of such entity.

"You" (or "Your") shall mean an individual or Legal Entity exercising permissions granted by this License.

"Source" form shall mean the preferred form for making modifications, including but not limited to software source code, documentation source, and configuration files.

"Object" form shall mean any form resulting from mechanical transformation or translation of a Source form, including but not limited to compiled object code, generated documentation, and conversions to other media types.

"Work" shall mean the work of authorship, whether in Source or Object form, made available under the License, as indicated by a copyright notice that is included in or attached to the work (an example is provided in the Appendix below).

"Derivative Works" shall mean any work, whether in Source or Object form, that is based on (or derived from) the Work and for which the editorial revisions, annotations, elaborations, or other modifications represent, as a whole, an original work of authorship. For the purposes of this License, Derivative Works shall not include works that remain separable from, or merely link (or bind by name) to the interfaces of, the Work and Derivative Works thereof.

"Contribution" shall mean any work of authorship, including the original version of the Work and any modifications or additions to that Work or Derivative Works thereof, that is intentionally submitted to Licensor for inclusion in the Work by the copyright owner or by an individual or Legal Entity authorized to submit on behalf of the copyright owner. For the purposes of this definition, "submitted" means any form of electronic, verbal, or written communication sent to the Licensor or its representatives, including but not limited to communication on electronic mailing lists, source code control systems, and issue tracking systems that are managed by, or on behalf of, the Licensor for the purpose of discussing and improving the Work, but excluding communication that is conspicuously marked or otherwise designated in writing by the copyright owner as "Not a Contribution."

"Contributor" shall mean Licensor and any individual or Legal Entity on behalf of whom a Contribution has been received by Licensor and subsequently incorporated within the Work.

2. Grant of Copyright License. Subject to the terms and conditions of this License, each Contributor hereby grants to You a perpetual, worldwide, non-exclusive, no-charge, royalty-free, irrevocable copyright license to reproduce, prepare Derivative Works of, publicly display, publicly perform, sublicense, and distribute the Work and such Derivative Works in Source or Object form.

3. Grant of Patent License. Subject to the terms and conditions of this License, each Contributor hereby grants to You a perpetual, worldwide, non-exclusive, no-charge, royalty-free, irrevocable (except as stated in this section) patent license to make, have made, use, offer to sell, sell, import, and otherwise transfer the Work, where such license applies only to those patent claims licensable by such Contributor that are necessarily infringed by their Contribution(s) alone or by combination of their Contribution(s) with the Work to which such Contribution(s) was submitted. If You institute patent litigation against any entity (including a cross-claim or counterclaim in a lawsuit) alleging that the Work or a Contribution incorporated within the Work constitutes direct or contributory patent infringement, then any patent licenses granted to You under this License for that Work shall terminate as of the date such litigation is filed.

4. Redistribution. You may reproduce and distribute copies of the Work or Derivative Works thereof in any medium, with or without modifications, and in Source or Object form, provided that You meet the following conditions:

- a. You must give any other recipients of the Work or Derivative Works a copy of this License; and
- b. You must cause any modified files to carry prominent notices stating that You changed the files; and
- c. You must retain, in the Source form of any Derivative Works that You distribute, all copyright, patent, trademark, and attribution notices from the Source form of the Work, excluding those notices that do not pertain to any part of the Derivative Works; and

- d. If the Work includes a "NOTICE" text file as part of its distribution, then any Derivative Works that You distribute must include a readable copy of the attribution notices contained within such NOTICE file, excluding those notices that do not pertain to any part of the Derivative Works, in at least one of the following places: within a NOTICE text file distributed as part of the Derivative Works; within the Source form or documentation, if provided along with the Derivative Works; or, within a display generated by the Derivative Works, if and wherever such third-party notices normally appear. The contents of the NOTICE file are for informational purposes only and do not modify the License. You may add Your own attribution notices within Derivative Works that You distribute, alongside or as an addendum to the NOTICE text from the Work, provided that such additional attribution notices cannot be construed as modifying the License.

You may add Your own copyright statement to Your modifications and may provide additional or different license terms and conditions for use, reproduction, or distribution of Your modifications, or for any such Derivative Works as a whole, provided Your use, reproduction, and distribution of the Work otherwise complies with the conditions stated in this License.

5. Submission of Contributions. Unless You explicitly state otherwise, any Contribution intentionally submitted for inclusion in the Work by You to the Licensor shall be under the terms and conditions of this License, without any additional terms or conditions. Notwithstanding the above, nothing herein shall supersede or modify the terms of any separate license agreement you may have executed with Licensor regarding such Contributions.

6. Trademarks. This License does not grant permission to use the trade names, trademarks, service marks, or product names of the Licensor, except as required for reasonable and customary use in describing the origin of the Work and reproducing the content of the NOTICE file.

7. Disclaimer of Warranty. Unless required by applicable law or agreed to in writing, Licensor provides the Work (and each Contributor provides its Contributions) on an "AS IS" BASIS, WITHOUT WARRANTIES OR CONDITIONS OF ANY KIND, either express or implied, including, without limitation, any warranties or conditions of TITLE, NON-INFRINGEMENT, MERCHANTABILITY, or FITNESS FOR A PARTICULAR PURPOSE. You are solely responsible for determining the appropriateness of using or redistributing the Work and assume any risks associated with Your exercise of permissions under this License.

8. Limitation of Liability. In no event and under no legal theory, whether in tort (including negligence), contract, or otherwise, unless required by applicable law (such as deliberate and grossly negligent acts) or agreed to in writing, shall any Contributor be liable to You for damages, including any direct, indirect, special, incidental, or consequential damages of any character arising as a result of this License or out of the use or inability to use the Work (including but not limited to damages for loss of goodwill, work stoppage, computer failure or malfunction, or any and all other commercial damages or losses), even if such Contributor has been advised of the possibility of such damages.

9. Accepting Warranty or Additional Liability. While redistributing the Work or Derivative Works thereof, You may choose to offer, and charge a fee for, acceptance of support, warranty, indemnity, or other liability obligations and/or rights consistent with this License. However, in accepting such obligations, You may act only on Your own behalf and on Your sole responsibility, not on behalf of any other Contributor, and only if You agree to indemnify, defend, and hold each Contributor harmless for any liability incurred by, or claims asserted against, such Contributor by reason of your accepting any such warranty or additional liability.

END OF TERMS AND CONDITIONS

APPENDIX: How to apply the Apache License to your work

To apply the Apache License to your work, attach the following boilerplate notice, with the fields enclosed by brackets "[]" replaced with your own identifying information. (Don't include the brackets!) The text should be enclosed in the appropriate comment syntax for the file format. We also recommend that a file or class name and description of purpose be included on the same "printed page" as the copyright notice for easier identification within third-party archives.

Copyright [yyyy] [name of copyright owner] Licensed under the Apache License, Version 2.0 (the "License"); you may not use this file except in compliance with the License. You may obtain a copy of the License at <http://www.apache.org/licenses/LICENSE-2.0> Unless required by applicable law or agreed to in writing, software distributed under the License is distributed on an "AS IS" BASIS, WITHOUT WARRANTIES OR CONDITIONS OF ANY KIND, either express or implied. See the License for the specific language governing permissions and limitations under the License.

mDNSResponder (part of mDNSShared)

* Copyright (c) 2003-2004, Apple Computer, Inc. All rights reserved.

*

* Redistribution and use in source and binary forms, with or without

* modification, are permitted provided that the following conditions are met:

*

* 1. Redistributions of source code must retain the above copyright notice,

* this list of conditions and the following disclaimer.

* 2. Redistributions in binary form must reproduce the above copyright notice,

* this list of conditions and the following disclaimer in the documentation

* and/or other materials provided with the distribution.

* 3. Neither the name of Apple Computer, Inc. ("Apple") nor the names of its

* contributors may be used to endorse or promote products derived from this

* software without specific prior written permission.

*

* THIS SOFTWARE IS PROVIDED BY APPLE AND ITS CONTRIBUTORS "AS IS" AND ANY

* EXPRESS OR IMPLIED WARRANTIES, INCLUDING, BUT NOT LIMITED TO, THE IMPLIED

* WARRANTIES OF MERCHANTABILITY AND FITNESS FOR A PARTICULAR PURPOSE ARE

* DISCLAIMED. IN NO EVENT SHALL APPLE OR ITS CONTRIBUTORS BE LIABLE FOR ANY

* DIRECT, INDIRECT, INCIDENTAL, SPECIAL, EXEMPLARY, OR CONSEQUENTIAL DAMAGES

* (INCLUDING, BUT NOT LIMITED TO, PROCUREMENT OF SUBSTITUTE GOODS OR SERVICES;

* LOSS OF USE, DATA, OR PROFITS; OR BUSINESS INTERRUPTION) HOWEVER CAUSED AND

* ON ANY THEORY OF LIABILITY, WHETHER IN CONTRACT, STRICT LIABILITY, OR TORT

* (INCLUDING NEGLIGENCE OR OTHERWISE) ARISING IN ANY WAY OUT OF THE USE OF THIS

* SOFTWARE, EVEN IF ADVISED OF THE POSSIBILITY OF SUCH DAMAGE.

*/

OpenSSL

OpenSSL License

/* =====

* Copyright (c) 1998-2011 The OpenSSL Project. All rights reserved.

*

* Redistribution and use in source and binary forms, with or without

* modification, are permitted provided that the following conditions

* are met:

*

* 1. Redistributions of source code must retain the above copyright

* notice, this list of conditions and the following disclaimer.

*

* 2. Redistributions in binary form must reproduce the above copyright

* notice, this list of conditions and the following disclaimer in

* the documentation and/or other materials provided with the

* distribution.

*

* 3. All advertising materials mentioning features or use of this

* software must display the following acknowledgment:

* "This product includes software developed by the OpenSSL Project

* for use in the OpenSSL Toolkit. (<http://www.openssl.org/>)"

*

* 4. The names "OpenSSL Toolkit" and "OpenSSL Project" must not be used to

* endorse or promote products derived from this software without

* prior written permission. For written permission, please contact

* openssl-core@openssl.org.

*

* 5. Products derived from this software may not be called "OpenSSL"

* nor may "OpenSSL" appear in their names without prior written

* permission of the OpenSSL Project.

*

* 6. Redistributions of any form whatsoever must retain the following

* acknowledgment:

* "This product includes software developed by the OpenSSL Project

* for use in the OpenSSL Toolkit (<http://www.openssl.org/>)"

*
* THIS SOFTWARE IS PROVIDED BY THE OpenSSL PROJECT ``AS IS" AND ANY
* EXPRESSED OR IMPLIED WARRANTIES, INCLUDING, BUT NOT LIMITED TO, THE
* IMPLIED WARRANTIES OF MERCHANTABILITY AND FITNESS FOR A PARTICULAR
* PURPOSE ARE DISCLAIMED. IN NO EVENT SHALL THE OpenSSL PROJECT OR
* ITS CONTRIBUTORS BE LIABLE FOR ANY DIRECT, INDIRECT, INCIDENTAL,
* SPECIAL, EXEMPLARY, OR CONSEQUENTIAL DAMAGES (INCLUDING, BUT
* NOT LIMITED TO, PROCUREMENT OF SUBSTITUTE GOODS OR SERVICES;
* LOSS OF USE, DATA, OR PROFITS; OR BUSINESS INTERRUPTION)
* HOWEVER CAUSED AND ON ANY THEORY OF LIABILITY, WHETHER IN CONTRACT,
* STRICT LIABILITY, OR TORT (INCLUDING NEGLIGENCE OR OTHERWISE)
* ARISING IN ANY WAY OUT OF THE USE OF THIS SOFTWARE, EVEN IF ADVISED
* OF THE POSSIBILITY OF SUCH DAMAGE.

* =====

*
* This product includes cryptographic software written by Eric Young
* (eay@cryptsoft.com). This product includes software written by Tim
* Hudson (tjh@cryptsoft.com).

*
*/

Original SSLeay License

/* Copyright (C) 1995-1998 Eric Young (eay@cryptsoft.com)
* All rights reserved.
*
* This package is an SSL implementation written
* by Eric Young (eay@cryptsoft.com).
* The implementation was written so as to conform with Netscapes SSL.
*
* This library is free for commercial and non-commercial use as long as
* the following conditions are aheared to. The following conditions
* apply to all code found in this distribution, be it the RC4, RSA,
* lhash, DES, etc., code; not just the SSL code. The SSL documentation
* included with this distribution is covered by the same copyright terms
* except that the holder is Tim Hudson (tjh@cryptsoft.com).
*

* Copyright remains Eric Young's, and as such any Copyright notices in
* the code are not to be removed.
* If this package is used in a product, Eric Young should be given attribution
* as the author of the parts of the library used.
* This can be in the form of a textual message at program startup or
* in documentation (online or textual) provided with the package.
*
* Redistribution and use in source and binary forms, with or without
* modification, are permitted provided that the following conditions
* are met:
* 1. Redistributions of source code must retain the copyright
* notice, this list of conditions and the following disclaimer.
* 2. Redistributions in binary form must reproduce the above copyright
* notice, this list of conditions and the following disclaimer in the
* documentation and/or other materials provided with the distribution.
* 3. All advertising materials mentioning features or use of this software
* must display the following acknowledgement:
* "This product includes cryptographic software written by
* Eric Young (eay@cryptsoft.com)"
* The word 'cryptographic' can be left out if the routines from the library
* being used are not cryptographic related :-).
* 4. If you include any Windows specific code (or a derivative thereof) from
* the apps directory (application code) you must include an acknowledgement:
* "This product includes software written by Tim Hudson (tjh@cryptsoft.com)"
*
* THIS SOFTWARE IS PROVIDED BY ERIC YOUNG ``AS IS" AND
* ANY EXPRESS OR IMPLIED WARRANTIES, INCLUDING, BUT NOT LIMITED TO, THE
* IMPLIED WARRANTIES OF MERCHANTABILITY AND FITNESS FOR A PARTICULAR PURPOSE
* ARE DISCLAIMED. IN NO EVENT SHALL THE AUTHOR OR CONTRIBUTORS BE LIABLE
* FOR ANY DIRECT, INDIRECT, INCIDENTAL, SPECIAL, EXEMPLARY, OR CONSEQUENTIAL
* DAMAGES (INCLUDING, BUT NOT LIMITED TO, PROCUREMENT OF SUBSTITUTE GOODS
* OR SERVICES; LOSS OF USE, DATA, OR PROFITS; OR BUSINESS INTERRUPTION)
* HOWEVER CAUSED AND ON ANY THEORY OF LIABILITY, WHETHER IN CONTRACT, STRICT
* LIABILITY, OR TORT (INCLUDING NEGLIGENCE OR OTHERWISE) ARISING IN ANY WAY
* OUT OF THE USE OF THIS SOFTWARE, EVEN IF ADVISED OF THE POSSIBILITY OF
* SUCH DAMAGE.
*
* The licence and distribution terms for any publically available version or

* derivative of this code cannot be changed. i.e. this code cannot simply be
* copied and put under another distribution licence
* [including the GNU Public Licence.]
*/

xpm

Copyright (c) 1989-95 GROUPE BULL

Permission is hereby granted, free of charge, to any person obtaining a copy of this software and associated documentation files (the "Software"), to deal in the Software without restriction, including without limitation the rights to use, copy, modify, merge, publish, distribute, sublicense, and/or sell copies of the Software, and to permit persons to whom the Software is furnished to do so, subject to the following conditions:

The above copyright notice and this permission notice shall be included in all copies or substantial portions of the Software.

THE SOFTWARE IS PROVIDED "AS IS", WITHOUT WARRANTY OF ANY KIND, EXPRESS OR IMPLIED, INCLUDING BUT NOT LIMITED TO THE WARRANTIES OF MERCHANTABILITY, FITNESS FOR A PARTICULAR PURPOSE AND NONINFRINGEMENT. IN NO EVENT SHALL GROUPE BULL BE LIABLE FOR ANY CLAIM, DAMAGES OR OTHER LIABILITY, WHETHER IN AN ACTION OF CONTRACT, TORT OR OTHERWISE, ARISING FROM, OUT OF OR IN CONNECTION WITH THE SOFTWARE OR THE USE OR OTHER DEALINGS IN THE SOFTWARE.

Except as contained in this notice, the name of GROUPE BULL shall not be used in advertising or otherwise to promote the sale, use or other dealings in this Software without prior written authorization from GROUPE BULL.

The Software Subjected to the Other License Conditions

Please refer to Table of Software and respective License terms below, for more detail and corresponding license conditions.

Table of Software

Names of Software	Terms and Conditions of the License: See Page
OpenSSL	2

OpenSSL

OpenSSL License

/* =====

* Copyright (c) 1998-2011 The OpenSSL Project. All rights reserved.

*

* Redistribution and use in source and binary forms, with or without

* modification, are permitted provided that the following conditions

* are met:

*

* 1. Redistributions of source code must retain the above copyright

* notice, this list of conditions and the following disclaimer.

*

* 2. Redistributions in binary form must reproduce the above copyright

* notice, this list of conditions and the following disclaimer in

* the documentation and/or other materials provided with the

* distribution.

*

* 3. All advertising materials mentioning features or use of this

* software must display the following acknowledgment:

* "This product includes software developed by the OpenSSL Project

* for use in the OpenSSL Toolkit. (<http://www.openssl.org/>)"

*

* 4. The names "OpenSSL Toolkit" and "OpenSSL Project" must not be used to

* endorse or promote products derived from this software without

* prior written permission. For written permission, please contact

* openssl-core@openssl.org.

*

* 5. Products derived from this software may not be called "OpenSSL"

* nor may "OpenSSL" appear in their names without prior written

* permission of the OpenSSL Project.

*

* 6. Redistributions of any form whatsoever must retain the following

* acknowledgment:

* "This product includes software developed by the OpenSSL Project

* for use in the OpenSSL Toolkit (<http://www.openssl.org/>)"

*
* THIS SOFTWARE IS PROVIDED BY THE OpenSSL PROJECT ``AS IS" AND ANY
* EXPRESSED OR IMPLIED WARRANTIES, INCLUDING, BUT NOT LIMITED TO, THE
* IMPLIED WARRANTIES OF MERCHANTABILITY AND FITNESS FOR A PARTICULAR
* PURPOSE ARE DISCLAIMED. IN NO EVENT SHALL THE OpenSSL PROJECT OR
* ITS CONTRIBUTORS BE LIABLE FOR ANY DIRECT, INDIRECT, INCIDENTAL,
* SPECIAL, EXEMPLARY, OR CONSEQUENTIAL DAMAGES (INCLUDING, BUT
* NOT LIMITED TO, PROCUREMENT OF SUBSTITUTE GOODS OR SERVICES;
* LOSS OF USE, DATA, OR PROFITS; OR BUSINESS INTERRUPTION)
* HOWEVER CAUSED AND ON ANY THEORY OF LIABILITY, WHETHER IN CONTRACT,
* STRICT LIABILITY, OR TORT (INCLUDING NEGLIGENCE OR OTHERWISE)
* ARISING IN ANY WAY OUT OF THE USE OF THIS SOFTWARE, EVEN IF ADVISED
* OF THE POSSIBILITY OF SUCH DAMAGE.

* =====

*
* This product includes cryptographic software written by Eric Young
* (eay@cryptsoft.com). This product includes software written by Tim
* Hudson (tjh@cryptsoft.com).

*
*/

Original SSLeay License

/* Copyright (C) 1995-1998 Eric Young (eay@cryptsoft.com)

* All rights reserved.

*

* This package is an SSL implementation written

* by Eric Young (eay@cryptsoft.com).

* The implementation was written so as to conform with Netscapes SSL.

*

* This library is free for commercial and non-commercial use as long as

* the following conditions are aheared to. The following conditions

* apply to all code found in this distribution, be it the RC4, RSA,

* lhash, DES, etc., code; not just the SSL code. The SSL documentation

* included with this distribution is covered by the same copyright terms

* except that the holder is Tim Hudson (tjh@cryptsoft.com).

*

* Copyright remains Eric Young's, and as such any Copyright notices in
 * the code are not to be removed.

* If this package is used in a product, Eric Young should be given attribution
 * as the author of the parts of the library used.

* This can be in the form of a textual message at program startup or
 * in documentation (online or textual) provided with the package.
 *

* Redistribution and use in source and binary forms, with or without
 * modification, are permitted provided that the following conditions
 * are met:

* 1. Redistributions of source code must retain the copyright
 * notice, this list of conditions and the following disclaimer.

* 2. Redistributions in binary form must reproduce the above copyright
 * notice, this list of conditions and the following disclaimer in the
 * documentation and/or other materials provided with the distribution.

* 3. All advertising materials mentioning features or use of this software
 * must display the following acknowledgement:
 * "This product includes cryptographic software written by
 * Eric Young (eay@cryptsoft.com)"
 * The word 'cryptographic' can be left out if the routines from the library
 * being used are not cryptographic related :-).

* 4. If you include any Windows specific code (or a derivative thereof) from
 * the apps directory (application code) you must include an acknowledgement:
 * "This product includes software written by Tim Hudson (tjh@cryptsoft.com)"
 *

* THIS SOFTWARE IS PROVIDED BY ERIC YOUNG ``AS IS" AND
 * ANY EXPRESS OR IMPLIED WARRANTIES, INCLUDING, BUT NOT LIMITED TO, THE
 * IMPLIED WARRANTIES OF MERCHANTABILITY AND FITNESS FOR A PARTICULAR PURPOSE
 * ARE DISCLAIMED. IN NO EVENT SHALL THE AUTHOR OR CONTRIBUTORS BE LIABLE
 * FOR ANY DIRECT, INDIRECT, INCIDENTAL, SPECIAL, EXEMPLARY, OR CONSEQUENTIAL
 * DAMAGES (INCLUDING, BUT NOT LIMITED TO, PROCUREMENT OF SUBSTITUTE GOODS
 * OR SERVICES; LOSS OF USE, DATA, OR PROFITS; OR BUSINESS INTERRUPTION)
 * HOWEVER CAUSED AND ON ANY THEORY OF LIABILITY, WHETHER IN CONTRACT, STRICT
 * LIABILITY, OR TORT (INCLUDING NEGLIGENCE OR OTHERWISE) ARISING IN ANY WAY
 * OUT OF THE USE OF THIS SOFTWARE, EVEN IF ADVISED OF THE POSSIBILITY OF
 * SUCH DAMAGE.
 *

* The licence and distribution terms for any publically available version or

* derivative of this code cannot be changed. i.e. this code cannot simply be
* copied and put under another distribution licence
* [including the GNU Public Licence.]
*/