

SAMSUNG

FULL MANUAL

MX-T70

Imagine the possibilities

Thank you for purchasing this Samsung product.

To receive more complete service, please register
your product at www.samsung.com/register

SAFETY INFORMATION









SAFETY WARNINGS

TO REDUCE THE RISK OF ELECTRIC SHOCK, DO NOT REMOVE THE COVER (OR BACK).

NO USER-SERVICEABLE PARTS ARE INSIDE.

REFER SERVICING TO QUALIFIED SERVICE PERSONNEL.

Refer to the table below for an explanation of symbols which may be on your Samsung product.

	CAUTION RISK OF ELECTRIC SHOCK. DO NOT OPEN.	
	This symbol indicates that high voltage is present inside. It is dangerous to make any kind of contact with any internal part of this product.	
	This symbol indicates that this product has included important literature concerning operation and maintenance.	
	Class II product : This symbol indicates that it does not require a safety connection to electrical earth (ground). If this symbol is not present on a product with a power cord, the product MUST have a reliable connection to protective earth (ground).	
	AC voltage : This symbol indicates that the rated voltage marked with the symbol is AC voltage.	
	DC voltage : This symbol indicates that the rated voltage marked with the symbol is DC voltage.	
	Caution, Consult instructions for use : This symbol instructs the user to consult the user manual for further safety related information.	

WARNING

- To reduce the risk of fire or electric shock, do not expose this appliance to rain or moisture.

CAUTION

- TO PREVENT ELECTRIC SHOCK, MATCH WIDE BLADE OF PLUG TO WIDE SLOT, FULLY INSERT.
- This apparatus shall always be connected to a AC outlet with a protective grounding connection.
- To disconnect the apparatus from the mains, the plug must be pulled out from the mains socket, therefore the mains plug shall be readily operable.
- Do not expose this apparatus to dripping or splashing. Do not put objects filled with liquids, such as vases on the apparatus.
- To turn this apparatus off completely, you must pull the power plug out of the wall socket. Consequently, the power plug must be easily and readily accessible at all times.

Wiring the Main Power Supply Plug (UK Only)

IMPORTANT NOTICE

The mains lead on this equipment is supplied with a moulded plug incorporating a fuse. The value of the fuse is indicated on the pin face of the plug and if it requires replacing, a fuse approved to BS1362 of the same rating must be used. Never use the plug with the fuse cover removed. If the cover is detachable and a replacement is required, it must be of the same colour as the fuse fitted in the plug. Replacement covers are available from your dealer. If the fitted plug is not suitable for the power points in your house or the cable is not long enough to reach a power point, you should obtain a suitable safety approved extension lead or consult your dealer for assistance.

However, if there is no alternative to cutting off the plug, remove the fuse and then safely dispose of the plug. Do not connect the plug to a mains socket as there is a risk of shock hazard from the bared flexible cord. Never attempt to insert bare wires directly into a mains socket. A plug and fuse must be used at all times.

IMPORTANT

The wires in the mains lead are coloured in accordance with the following code:– BLUE = NEUTRAL BROWN = LIVE As these colours may not correspond to the coloured markings identifying the terminals in your plug, proceed as follows:– The wire coloured BLUE must be connected to the terminal marked with the letter N or coloured BLUE or BLACK. The wire coloured BROWN must be connected to the terminal marked with the letter L or coloured BROWN or RED.

WARNING : DO NOT CONNECT EITHER WIRE TO THE EARTH TERMINAL WHICH IS MARKED WITH THE LETTER E OR BY THE EARTH SYMBOL , OR COLOURED GREEN OR GREEN AND YELLOW.

PRECAUTIONS

1. Ensure that the AC power supply in your house complies with the power requirements listed on the identification sticker located on the rear of your product. Install your product horizontally, on a suitable base (furniture), with enough space around it for ventilation (7~10 cm). Make sure the ventilation slots are not covered. Do not place the unit on amplifiers or other equipment which may become hot. This unit is designed for continuous use. To fully turn off the unit, disconnect the AC plug from the wall outlet. Unplug the unit if you intend to leave it unused for a long period of time.
2. During thunderstorms, disconnect the AC plug from the wall outlet. Voltage peaks due to lightning could damage the unit.
3. Do not expose the unit to direct sunlight or other heat sources. This could lead to overheating and cause the unit to malfunction.
4. Protect the product from moisture (i.e. vases), and excess heat (e.g. a fireplace) or equipment creating strong magnetic or electric fields. Unplug the power cable from the AC wall socket if the unit malfunctions. Your product is not intended for industrial use. It is for personal use only. Condensation may occur if your product has been stored in cold temperatures. If transporting the unit during the winter, wait approximately 2 hours until the unit has reached room temperature before using.
5. The battery used with this product contains chemicals that are harmful to the environment. Do not dispose of the battery in the general household trash. Do not expose the battery to excess heat, direct sunlight, or fire. Do not short circuit, disassemble, or overheat the battery. Danger of explosion if the battery is replaced incorrectly. Replace only with the same or equivalent type.

ABOUT THIS MANUAL

The user manual has two parts: this simple paper USER MANUAL and a detailed FULL MANUAL you can download.



USER MANUAL

See this manual for safety instructions, product installation, components, connections, and product specifications.



FULL MANUAL

You can access the FULL MANUAL on Samsung's on-line customer support center by scanning the QR code on the left. To see the manual on your PC or mobile device, download the manual in document format from Samsung's website. (<http://www.samsung.com/support>)

Design and specifications are subject to change without prior notice.

CONTENTS

01	Checking the Components	2
	Inserting Batteries before using the Remote Control (AAA batteries X 2)	2
02	Product Overview	3
	Top Panel of the Party Audio	3
	Rear Panel of the Party Audio	4
03	Connecting the Party Audio	6
	Connecting Electrical Power	6
	How to use Audio Group	7

04	Connecting an External Device	12
	Connecting using an Analogue Audio (AUX) Cable	12
	Connecting a mobile device via Bluetooth	13
05	Connecting a USB Storage Device	16
	Software Update	17
06	Using the Remote Control	18
	How to Use the Remote Control	18
	How to use Sound Mode	20
	How to use the DJ Effect	20
07	Using the Samsung Giga Party Audio app	21
	Install Samsung Giga Party Audio App	21
	Launching the Samsung Giga Party Audio App	21
08	Troubleshooting	22
09	Licence	23
10	Open Source Licence Notice	23
11	Important Notes About Service	23
12	Specifications and Guide	24
	Specifications	24

01 CHECKING THE COMPONENTS



Party Audio Main Unit

Remote Control / Batteries

Power Cord

- For more information about the power supply and power consumption, refer to the label attached to the product. (Label: Rear of the Party Audio Main Unit)
- To purchase additional components or optional cables, contact a Samsung Service Centre or Samsung Customer Care.
- When moving the product, do not drag or pull the product from the ground. Lift the product when moving the product.

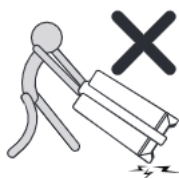

Inserting Batteries before using the Remote Control (AAA batteries X 2)



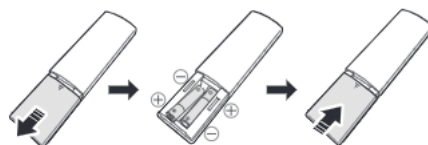

Slide the battery cover in the direction of the arrow until it is completely removed. Insert 2 AAA batteries (1.5V) oriented so that their polarity is correct. Slide the battery cover back into position.

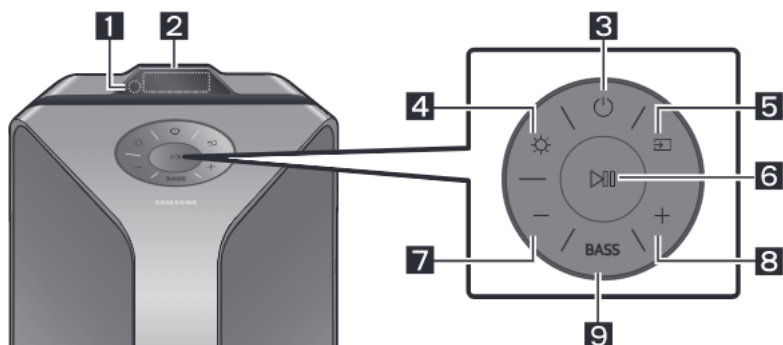

02 PRODUCT OVERVIEW

Top Panel of the Party Audio



1	Remote Sensor	When operating the Party Audio system, please aim the front of the remote control at the remote sensor.
2	Display Window	Displays operating messages or current status of the Party Audio system.
3	Power	Turns the Party Audio on and off.
4	Light	Press the  (Light) button to turn the Lighting Mode on. Press the button repeatedly to cycle through the available lighting modes: AMBIENT, PARTY, DANCE, THUNDERBOLT, STAR or OFF .
5	Source	Press to select a source connected to the Party Audio. Press and hold the  (Source) button for more than 5 seconds to enter the " BT PAIRING " mode.
6	Play/Pause	<ul style="list-style-type: none"> • Play/Pause Press the  button to pause a music file temporarily. When you press the button again, the music file plays. • Demo play Press and hold the  button for more than 5 seconds to start the Demo play while the system is turned on. "DEMO" appears on the display and it plays demo music for 60 seconds. To cancel Demo Play, press and hold the  button for more than 5 seconds during Demo Play. <ul style="list-style-type: none"> - If you input any commands while in demo play, 60 seconds timer is refreshed. - All the buttons on the remote control and rear panel are disabled while in demo play. If you want to use the remote control, cancel the demo play. - Demo play is cancelled when you change the source or power off the system.

7	Volume down	Press the — (Volume down) button to lower the volume. Press and hold the — (Volume down) button to quickly lower the volume.
8	Volume up	Press the + (Volume up) button to raise the volume. Press and hold the + (Volume up) button to quickly raise the volume.
9	BASS	Press the BASS button to use the powerful bass sound. Press it again to return to the normal sound. Press and hold the BASS button for more than 5 seconds to turn on or off the BLUETOOTH POWER function.

Rear Panel of the Party Audio

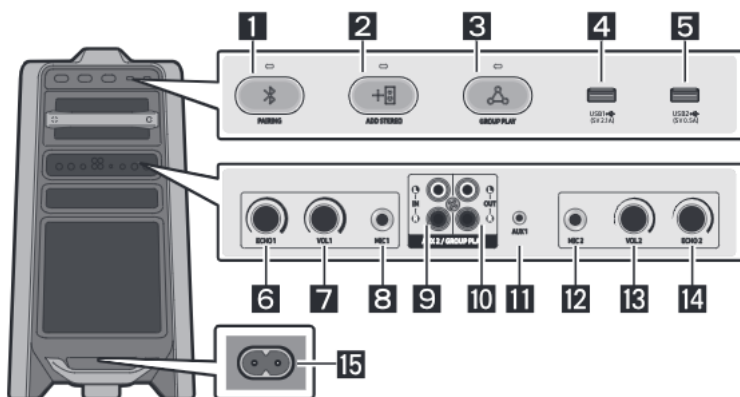

1	Bluetooth PAIRING	Press the PAIRING button to enter the “ BT PAIRING ” mode. You can connect the Party Audio to a new Bluetooth device in this mode by selecting the Party Audio from the Bluetooth device’s search list.
2	ADD STEREO	Press the ADD STEREO button to connect to another Party Audio wirelessly. Press the ADD STEREO button again before connecting another Party Audio to exit Stereo Group mode. When the connection is made, you can enjoy stereo sound. Press and hold the ADD STEREO button for more than 5 seconds to disconnect the Stereo Group mode.
3	GROUP PLAY	Press the GROUP PLAY button to connect up to ten Party Audio systems wirelessly. Press the GROUP PLAY button again before connecting other Party Audio to exit wireless Group Play. When the connection is made, you can use multiple Party Audio systems at the same time using Group Play mode. Press and hold the GROUP PLAY button for more than 5 seconds to disconnect the wireless Group Play mode.
4	USB1	Connect a USB device to the USB1 or USB2 ports on the main unit. If you connect your cell phone to the USB1 port, you can charge it.
5	USB2	<ul style="list-style-type: none"> Press the Source button to select USB1 or USB2.

6	ECHO1	You can give an echo effect to the sound from a connected microphone (MIC1) by adjusting the ECHO1 knob. If you turn clockwise, the echo effect goes up, and if you turn counter-clockwise, the echo effect goes down.
7	VOL1	Use the VOL1 knob to adjust the volume of a connected microphone (MIC1). If you turn clockwise, the volume goes up, and if you turn counter-clockwise, the volume goes down.
8	MIC1	Connect your microphone to the MIC1 jack.
9	AUX2/ GROUP PLAY IN Terminals	Use an Audio Cable (not supplied) to connect AUX2 (IN) terminals on the main unit to Audio Out on an external analogue output device. <ul style="list-style-type: none"> • Be sure to match connector colours. • If the external analogue output device has only one Audio Out jack, connect either left or right. • Press the  (Source) button to select AUX2. • If the product is in AUX2 mode with no playback and no command input for more than 20 minutes, the system will turn off. • If the product is in AUX2 mode with playback for more than 8 hours and no command input, the system will turn off.
10	GROUP PLAY OUT Terminals	Use an Audio Cable (not supplied) to connect GROUP PLAY (OUT) terminals on the main unit to Audio In on an external analogue output device. <ul style="list-style-type: none"> • Be sure to match connector colours. • If the external analogue output device has only one Audio In jack, connect either left or right.
11	AUX1	Use an Audio (AUX) Cable (not supplied) to connect AUX1 jack on the main unit to Audio Out on an external device. <ul style="list-style-type: none"> • If the product is in AUX1 mode with no playback and no command input for more than 20 minutes, the system will turn off. • If the product is in AUX1 mode with playback for more than 8 hours and no command input, the system will turn off.
12	MIC2	Connect your microphone to the MIC2 jack.
13	VOL2	Use the VOL2 knob on the main unit to adjust the volume of a connected microphone (MIC2). If you turn clockwise, the volume goes up, and if you turn counter-clockwise, the volume goes down.
14	ECHO2	You can give an echo effect to the sound from a connected microphone (MIC2) by adjusting the ECHO2 knob. If you turn clockwise, the echo effect goes up, and if you turn counter-clockwise, the echo effect goes down.
15	Power	Connect the power cord to the Power jack and connect the other end of the power cord to a wall socket to supply electrical power to the Party Audio.

03 CONNECTING THE PARTY AUDIO

Connecting Electrical Power

Use the power cord to connect the Party Audio to an electrical outlet in the following order:

Connect the power cord to the Party Audio and then to a wall socket.

See the illustrations below.

- For more information about the required electrical power and power consumption, refer to the label attached to the product. (Label: Rear of the Party Audio)

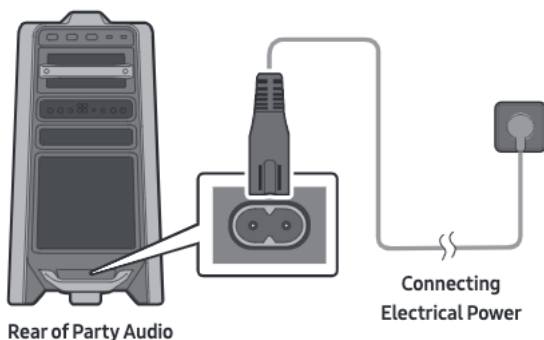

How to use Audio Group

You can connect multiple audio systems in a group to create a party environment and produce higher sound output. Set one Party Audio as the host and any music played on it will be shared among any other Party Audio systems in the Audio group.

Connecting the wired Group Play mode

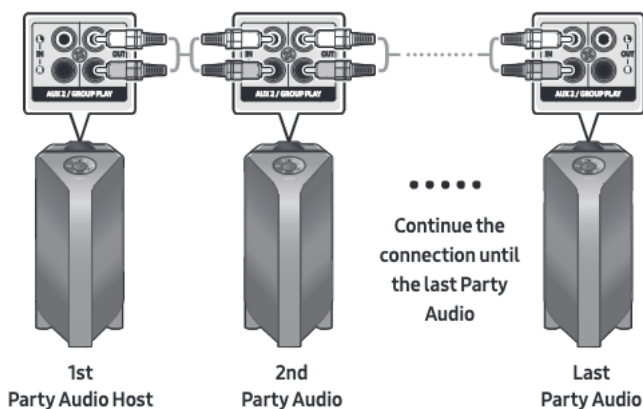

Set up Group Play by connecting all the systems using audio cables (not supplied). Use the **AUX** or **(Source)** button to change the source to **AUX2** for every Party Audio system except the 1st (or host) Party Audio system.

NOTES

- The 1st Party Audio Host can play music from any source.
- Depending on the length or characteristics of the cable, there may be a difference in operating distance.

Connecting the wireless Group Play mode

You can connect up to ten Party Audio systems with the wireless Group Play function.

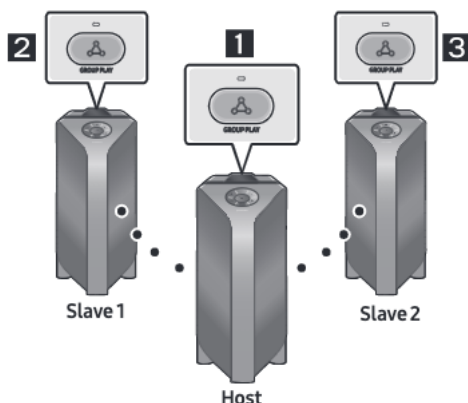

1. Press the **GROUP PLAY** button on the Host Party Audio system. The “**HOST**” message appears on the display of the host Party Audio and the LED blinks on the **GROUP PLAY** button.
2. Press the **GROUP PLAY** button on the 2nd Party Audio system (Slave 1). The “**GROUP PLAY CONNECTED**” message appears on the display and the **GROUP PLAY** button on both systems stops blinking.
3. Press the **GROUP PLAY** button on the 3rd Party Audio system (Slave 2). The “**GROUP PLAY CONNECTED**” message appears on the display and the **GROUP PLAY** button on the system stops blinking.
4. If you want to add more Party Audio systems, repeat step 3.
5. Play music on the Host Party Audio. Sound outputs from all the connected systems.

NOTES

- The wireless Group Play connection is available for any Party Audio system.
- Environmental conditions or other factors with connected devices may have effect on playback quality.
- If the red LED is on the **GROUP PLAY** button, an error has occurred in the wireless Group Play connection. Try step 1 to step 5 again.
- The **ADD STEREO** button and **PAIRING** button on the slave Party Audio systems are not available while in wireless Group Play mode.
- The **ADD STEREO** button on the host Party Audio system is not available while in wireless Group Play mode.
- When adding a slave unit, if you press and hold **GROUP PLAY** on the slave, before the “**GROUP PLAY CONNECTED**” message appears, it will become the Host unit instead.

- All slave units must be connected one by one. For example, after Host is connected, press **GROUP PLAY** button on slave 1 to connect, and after slave 1 is connected, you should connect slave 2 and slave 3 one by one sequentially.
- While using Group Play, currently connected Bluetooth devices are disconnected and Bluetooth connection is disabled.
- Bluetooth devices can search and connect with the host Party Audio only.
- When in Group Play mode, the slaves cannot connect to a Bluetooth device.
- If you power off and then power on the Party Audio or select any source other than **BT** on a slave unit, in Group Play mode, the Group Play mode is disconnected.
- This product does not support aptX audio stream with Wireless Group Play mode.

Disconnecting the wireless Group Play mode

1. Press and hold the **GROUP PLAY** button over 5 seconds (Host or Slaves) after Group Play is connected or press the **GROUP PLAY** button (Host or Slaves) before Group Play is connected.
 - “**OFF-GROUP PLAY**” appears on the display and the LED above the **GROUP PLAY** button is off.
2. If you select any source other than **BT** on the slave units or turn off the host Party Audio, the Group Play mode is disconnected.
 - If the disconnection is made from the host Party Audio, Group Play is disconnected.

LED Indications

LED	STATE	Description
Green	Blink	Waiting for a wireless Group Play connection.
	Solid	The wireless Group Play connection was successful.
Red	Solid	There is an error with the wireless Group Play connection.

Using the Stereo Group mode

You can enjoy stereo sound by connecting two Party Audio systems.

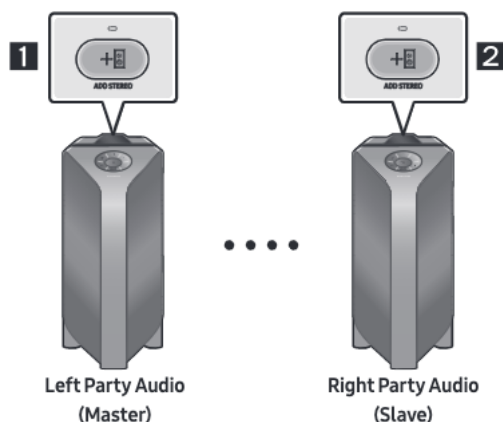

1. Press the **ADD STEREO** button on the left Party Audio system. The “**ADD STEREO**” message appears on the display and the LED blinks on the **ADD STEREO** button.
2. Press the **ADD STEREO** button on the right Party Audio system. The “**ADD STEREO**” message appears on the display and the LED blinks on the **ADD STEREO** button.
3. When the connection is made, The “**BT PAIRING**” message appears on the master Party Audio system and “**STEREO MODE**” appears on the slave Party Audio system.
 - The master Party Audio system outputs left channel sound and the slave Party Audio system outputs right channel sound. If you want to change the sound channels of Party Audio systems, press the **ADD STEREO** button on the current master Party Audio system.
4. Play music on the Party Audio. Sound outputs from both Party Audio systems.

NOTES

- To use the Stereo Group mode, both Party Audio systems must be the same model.
- Environmental conditions or other factors with connected devices may have effect on playback quality.
- If the red LED is on the **ADD STEREO**, an error has occurred in the Stereo Group connection. Try step 1 and step 4 again.
- All the buttons except **ADD STEREO** button and **Power** on the slave Party Audio systems are disabled while in Stereo Group mode.
- The **GROUP PLAY** button on the host Party Audio system is not available while in Stereo Group mode.

- While in Stereo Group mode, currently connected Bluetooth devices are disconnected and Bluetooth connection is disabled.
- If you select any source other than **BT** or power cycle the master Party Audio, the Stereo Group mode is disconnected.
- This product does not support aptX audio stream with Wireless Group Play mode.
- If you try to connect a Bluetooth device while Stereo Group is connecting, the Stereo Group mode may fail.

Disconnecting the Stereo Group mode

1. Press and hold the **ADD STEREO** button over 5 seconds (Master or Slave) after Stereo Group is connected or press the **ADD STEREO** button (Master or Slave) before Stereo Group is connected.
 - “**OFF-ADD STEREO**” appears on the display and the LED above the **ADD STEREO** button is off.
2. If you select any source other than **BT** on the slave units or the master Party Audio is turned off and then back on, the Stereo Group mode is disconnected.
 - If one of the Party Audio is disconnected from Stereo Group mode, another Party Audio is automatically disconnected.

LED Indications

LED	STATE	Description
Green	Blink	Waiting for a Stereo Group connection.
	Solid	The Stereo Group connection is successful.
Red	Solid	There is an error with the Stereo Group connection.

04 CONNECTING AN EXTERNAL DEVICE

Connect to an external device via a wired or wireless network to play the external device's sound through the Party Audio.

Connecting using an Analogue Audio (AUX) Cable

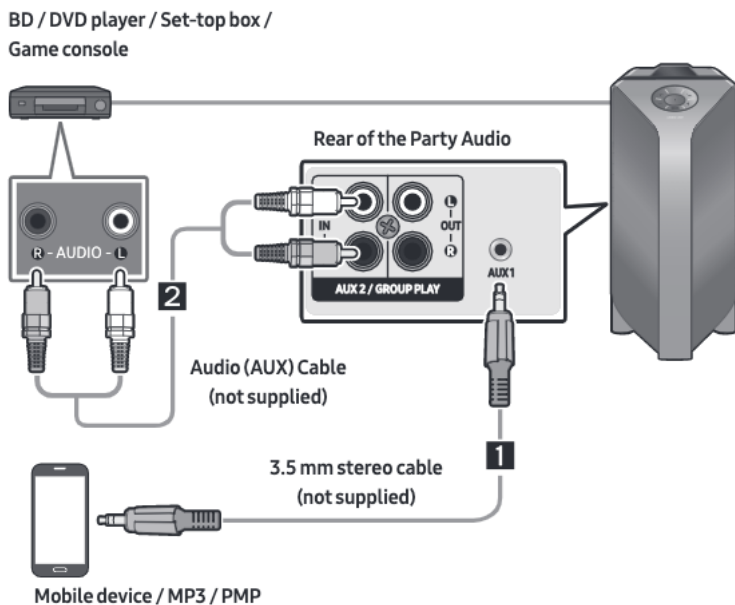

1 3.5 mm stereo Cable (AUX1)

1. Connect **AUX1** jack on the main unit to the AUDIO OUT jack of the Source Device using an 3.5 mm stereo cable .
2. Select "**AUX1**" mode by pressing the  (**Source**) button on the top panel or on the remote control.
 - You can also select a source using **AUX** button on the remote control.

2 Audio Cable (AUX2)

1. Connect **AUX2 (IN)** terminals on the main unit to the AUDIO OUT terminals of the Source Device using an audio cable .
2. Select "**AUX2**" mode by pressing the  (**Source**) button on the top panel or on the remote control.
 - You can also select a source using **AUX** button on the remote control.

Connecting a mobile device via Bluetooth

When a mobile device is connected using Bluetooth, you can hear stereo sound without the hassle of cabling.

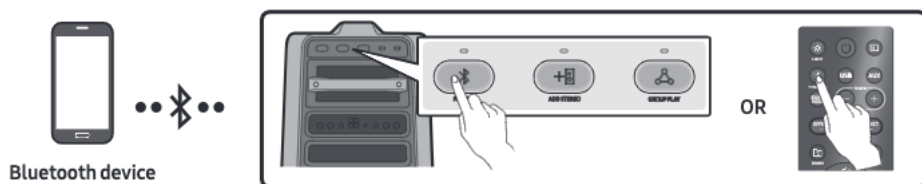

The initial connection

1. Press and hold the **PAIRING** button on the remote control for more than 5 seconds to enter the “**BT PAIRING**” mode.
(OR) Press the **PAIRING** button on the rear panel or press and hold the **Source** button on the top panel for more than 5 seconds to enter the “**BT PAIRING**” mode.
2. On your device, select “[AV] Samsung Party T70” from the list that appears.
 - When the Party Audio is connected to the Bluetooth device, [Bluetooth Device Name] → “**BT**” appears in the front display.
3. Play music files from the device connected via Bluetooth through the Party Audio.

If the device fails to connect

- If a previously connected Party Audio listing (e.g. “[AV] Samsung Party T70”) appears in the list, delete it.
- Then repeat steps 1 and 2.

What is the difference between BT READY and BT PAIRING?

- **BT READY** : In this mode, you can search for previously connected TVs or connect a previously connected mobile device to the Party Audio.
- **BT PAIRING** : In this mode, you can connect a new device to the Party Audio.
(Press and hold the **PAIRING** button on the remote control or the **Source** button on top of the Party Audio for more than 5 seconds to enter the “**BT PAIRING**” mode.)
 - You can also press the **PAIRING** button on the rear of the Party Audio to enter the “**BT PAIRING**” mode.

Bluetooth Multi connection

The Party Audio can be connected to 2 Bluetooth devices at the same time.

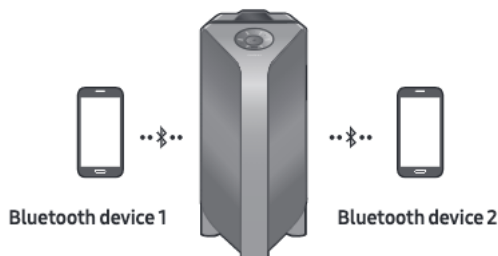

1. Connect the Party Audio to up to two Bluetooth devices. (See page 13)
2. If you attempt to connect a 3rd Bluetooth device, the 1st and 2nd devices will disconnect.
3. Play music from one of the connected Bluetooth devices while two devices are connected. The other device will automatically pause.
 - Depending on the device, and the content being played, playback may not be able to be automatically paused when switching from device to device.

NOTES

- You can connect up to two Bluetooth devices at a time.
- If asked for a PIN code when connecting a Bluetooth device, enter <0000>.
- Environmental conditions or other factors with connected devices may have effect on playback quality.
- The Party Audio automatically turns off after 20 minutes with no command input in the ready state.
- The Party Audio may not perform Bluetooth search or connection correctly under the following circumstances:
 - If there is a strong electrical field around the Party Audio.
 - If several Bluetooth devices are simultaneously paired with the Party Audio.
 - If the Bluetooth device is turned off, not in place, or malfunctions.
- Electronic devices may cause radio interference. Devices that generate electromagnetic waves must be kept away from the Party Audio main unit - e.g., microwaves, wireless LAN devices, etc.
- When the Party Audio is connected to your TV by Bluetooth connection, the video on the TV and audio from the Party Audio may not be synchronised because the distance between the Party Audio and the TV is too far. It is recommended to move the Party Audio closer to your TV within 1 meter.
- When the speaker is in the Bluetooth Multi connection mode, you will need to connect the other Bluetooth device and speaker within a few minutes (Approx. 1 minute). Otherwise Bluetooth Multi connection mode will be cancelled.

- Bluetooth Multi connection may not be supported depending on the connected device's specifications.
- Removable/detachable Bluetooth devices (Ex:Dongle etc..) ,windows phone, laptops, TV, etc. do not support Bluetooth Multi connection.
- After Bluetooth Multi connection pairing, there may be a slight delay before music starts playing depending on the Bluetooth devices.
- If you move too far out of range from the Party Audio without first disconnecting your Bluetooth device, it may take a few minutes to connect other Bluetooth devices. If you turn the Party Audio off and back on, you can connect other Bluetooth devices without waiting.

LED Indications

LED	STATE	Description
Blue	Fast Blink	BT PAIRING mode
	Blink	BT READY mode
	Solid	A Bluetooth device is connected.

Using Bluetooth Power On

When the Party Audio is turned off, you can connect your smart device via a Bluetooth connection to turn it on.

1. Press and hold the **BASS** button on the remote control or on the top panel to set the Bluetooth Power On function on. "**ON-BLUETOOTH POWER**" appears on the display.
2. When the Party Audio is off, connect your smart device via Bluetooth. (For information on Bluetooth connections, refer to your smart device's manual.)
3. When the connection is complete, the Party Audio turns itself on automatically in Bluetooth mode.
 - Select the desired music to play from your smart device.

NOTE

- Press and hold the **BASS** button for more than 5 seconds on the remote control or on the top panel to turn the Bluetooth Power On function on or off.

Each time you press the **BASS** button, the Party Audio displays :

ON-BLUETOOTH POWER → OFF-BLUETOOTH POWER

05 CONNECTING A USB STORAGE DEVICE

You can play music files located on USB storage devices through the Party Audio.

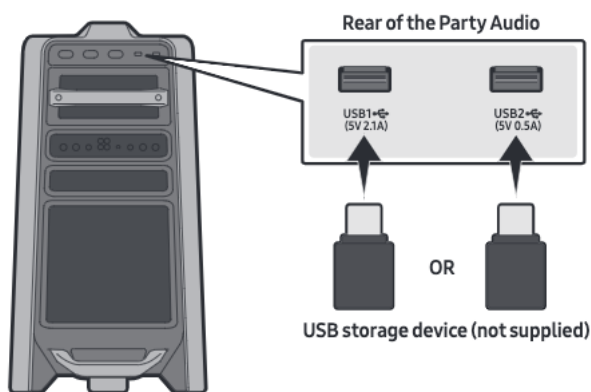

1. Connect a USB storage device to the USB1 or USB2 jacks on your Party Audio.
2. Press the  (**Source**) button on the top panel or on the remote control, and then select "**USB1**" or "**USB2**".
 - You can also select a source using **USB** button on the remote control.
3. "**USB1**" or "**USB2**" appears in the display screen.
4. Play music files from the USB storage device through the Party Audio.
 - The Party Audio automatically turns off (Auto Power Down) if USB device is not connected, playback stopped, or there is no input for more than 20 minutes.

NOTES

- This product only supports USB storage devices that are formatted in the FAT and FAT32 file system.
- This product does not support HDD storage or storage on mobile devices.
- A maximum of 999 files can be played per USB storage device.
- A maximum of 256 folders can be read per USB storage device.

Supported Audio Formats

File Extension	Audio Codec	Sampling Rate	Bit Rate
*.mp3	MPEG 1 Layer3	32 kHz ~ 48 kHz	32 kbps ~ 320 kbps
	MPEG 2 Layer3	16 kHz ~ 24 kHz	8 kbps ~ 160 kbps
	MPEG 2.5 Layer3	8 kHz ~ 12 kHz	8 kbps ~ 160 kbps
*.wma	WMA7/8/9	8 kHz ~ 48 kHz	32 kbps ~ 320 kbps
*.aac	AAC	8 kHz ~ 96 kHz	< 1728 kbps
	AAC-LC	8 kHz ~ 96 kHz	< 1728 kbps
	HE-AAC	8 kHz ~ 96 kHz	< 1728 kbps
*.wav	PCM/LPCM/ IMA_ADPCM	8 kHz ~ 192 kHz	< 5 Mbps
*flac	-	8 kHz ~ 192 kHz	< 5 Mbps

NOTES

- This product does not support WMA Professional codec.
- The above table shows supported sampling rates and bit rates. Files in formats that are not supported will not play.
- AAC files only support the ADTS native format.

Software Update







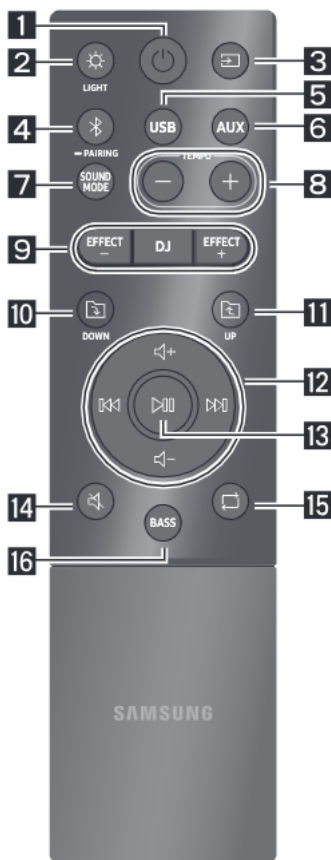

Samsung may offer updates for the Party Audio's system firmware in the future.





















If an update is offered, you can update the firmware by connecting a USB device with the firmware update stored on it to the **USB1** or **USB2** port on your Party Audio. For more information about how to download update files, go to the Samsung Electronics website at www.samsung.com/us/support/. Then, enter or select the model number of your Party Audio, select the Software & Apps option, and then Downloads. Note that the option names can vary.



06 USING THE REMOTE CONTROL

How to Use the Remote Control



1	 Power	Turn the Party Audio on and off.
2	 LIGHT	Press the  (LIGHT) button to turn the Lighting Mode on. Press the button repeatedly to cycle through the available light modes: AMBIENT, PARTY, DANCE, THUNDERBOLT, STAR or OFF .
3	 Source	Press to select a source connected to the Party Audio. Press the button repeatedly to cycle through the available sources: BT, USB1, USB2, AUX1 or AUX2 .
4	 Bluetooth PAIRING	Press to select a source connected directly to "BT" mode. Press and hold the button for more than 5 seconds to enter the "BT PAIRING" mode. You can connect the Party Audio to a new Bluetooth device in this mode by selecting the Party Audio from the Bluetooth device's search list.
5	 USB	Press to select the USB1 or USB2 sources connected to the Party Audio.
6	 AUX	Press to select the AUX1 or AUX2 sources connected to the Party Audio.
7	 SOUND MODE	Press the button repeatedly to cycle through the available sound effects: PARTY, STANDARD, HIPHOP, EDM, ROCK, LATIN, HOUSE or REGGAE .

8	 <p>TEMPO +/-</p>	<p>Press the TEMPO + or TEMPO - buttons to change the tempo of the music up or down.</p> <ul style="list-style-type: none"> This function only works in the USB1 and USB2 mode.
9	 <p>DJ</p>	<p>This function lets you turn on the DJ effect function.</p> <p>Press the button repeatedly to cycle through the available DJ sound effects: NOISE, FILTER, CRUSH, CHORUS, WAHWAH or OFF.</p>
	 <p>EFFECT +/-</p>	<p>Press the EFFECT + or EFFECT - buttons to change the level of the each DJ sound effect up or down.</p>
10	 <p>Folder DOWN</p>	<p>Press the  (DOWN) button to move to the next folder in the USB device.</p>
11	 <p>Folder UP</p>	<p>Press the  (UP) button to move to the previous folder in the USB device.</p>
12	 <p>Volume up, Volume down / Skip</p>	<ul style="list-style-type: none"> Volume up, Volume down Press the + (Volume up) or - (Volume down) to adjust the volume level up or down. Music Skip Press the  button to select the next music file. Press the  button to select the previous music file. Press and hold the  button or the  button for more than 3 seconds in USB play mode to search forward or search backward. Press and hold the  button or the  button for more than 3 seconds again to get back to normal play.
13	 <p>Play / Pause</p>	<p>Press the  button to pause a music file temporarily. When you press the button again, the music file plays.</p> <ul style="list-style-type: none"> Auto Power Down Function To turn off Auto Power Down function while the unit is in AUX1, AUX2 mode, press and hold the  button for more than 5 seconds. ON-AUTO POWER DOWN / OFF-AUTO POWER DOWN appears on the display.
14	 <p>Mute</p>	<p>Press the  (Mute) button to mute the sound. Press it again to unmute the sound.</p>

15	 Repeat	Press the  (Repeat) button to use the Repeat function in " USB1 " and " USB2 " mode. Press the button repeatedly to cycle through the available repeat functions: ONE, FOLDER, ALL, RANDOM or OFF .
16	 BASS	Press the BASS button to use the powerful bass sound. Press it again to return to the normal sound. Press and hold the BASS button for more than 5 seconds to turn on or off the BLUETOOTH POWER function.

How to use Sound Mode

Your Party Audio provides predefined equaliser settings that are optimised for particular music genres.

1. Press the **SOUND MODE** button on the Remote control.
2. Each time you press the **SOUND MODE** button, the Party Audio cycles through the available sound effects: **PARTY, STANDARD, HIPHOP, EDM, ROCK, LATIN, HOUSE** or **REGGAE**.

NOTES

- Default sound mode is **PARTY**.
- When turned off, press and hold the  button on product or remote control for more than 5 seconds to turn on in the default Sound Mode setting.

How to use the DJ Effect

The DJ Effect function lets you add DJ sound effects to your music. The level of each effect is adjustable.

1. Press the **DJ** button on the Remote control.
2. Each time you press the **DJ** button, the Party Audio cycles through the available DJ Effects:
 - **NOISE** : Create white noise and mixed with the original sound through the filter and output.
 - **FILTER** : Creates an effect similar to the sound of only treble or bass.
 - **CRUSH** : Creates an effect that makes the original sound sharper.
 - **CHORUS** : Creates an effect similar to a singing chorus.
 - **WAHWAH** : Creates a 'Wah~ Wah~' effect.
 - **DJ EFFECT OFF** : Turns off the DJ Effect.
3. Press the **EFFECT +** or **EFFECT -** buttons to raise or lower the level of each of the DJ sound effects from -15 to +15.

NOTE

- When turned off, press and hold the  button on product or remote control for more than 5 seconds to turn on in the default DJ Effect setting.

07 USING THE SAMSUNG GIGA PARTY AUDIO APP

Install Samsung Giga Party Audio App

To control this product with your Smart Device and the Samsung Giga Party Audio app, download the Samsung Giga Party Audio App from the Google Play Store or Apple App Store, and install it on your Smart Device.

NOTES

- The Samsung Giga Party Audio app is compatible with Android mobile phone devices running Android OS 6.0 or later.
- The Samsung Giga Party Audio app is compatible with Apple mobile devices running iOS 10.0 or later.

Market search : Samsung Giga Party Audio



Launching the Samsung Giga Party Audio App

To launch and use the Samsung Giga Party Audio app, touch the Giga Party Audio icon on your smart device, and then follow the directions on the screen.



08 TROUBLESHOOTING

Before seeking assistance, check the following.

The unit will not turn on.

Is the power cord plugged into the outlet?

→ Connect the power plug to the outlet.

A function does not work when the button is pressed.

Is there static electricity in the air?

→ Disconnect the power plug and connect it again.

Sound dropouts occur in BT mode.

→ See the Bluetooth connection sections on page 13.

Sound is not produced.

Is the Mute function on?

→ Press the  (Mute) button to cancel the mute function.

Is the volume set to minimum?

→ Adjust the Volume.

The remote control does not work.

Are the batteries drained?

→ Replace them with new batteries.

Is the distance between the remote control and Party Audio main unit too far?

→ Move the remote control closer to the Party Audio main unit.

Stereo Group connection is not working.

Is the system in wireless Group Play mode?

→ Disconnect the wireless Group Play mode and try Stereo Group connection again.

It cannot make a Bluetooth connection.

Is the system connected to another system in wireless Group Play mode or Stereo Group mode?

→ Try Bluetooth connection again after disconnecting the wireless Group Play or Stereo Group connection.

Are the two Bluetooth devices already connected?

→ Try Bluetooth connection again after disconnecting other Bluetooth connections.

The PAIRING button is not working.

Is the system in wireless Group Play mode or Stereo Group mode?

→ Try again after disconnecting the wireless Group Play or Stereo Group connection.

I want to switch the host system to the other in wireless Group Play or Stereo Group connection.

- Disconnect Group Play mode, press the Speaker which you want make to host first, and after it displays "HOST" message, connect the others one by one.
- With Stereo Group mode, host is fixed. You can not change others as host.

I want to play AUX1 or AUX2 more than 8 hours without control input.

- Press and hold the  button for more than 5 seconds in AUX1 or AUX2 mode to disable Auto Power Down Function. Change from ON-AUTO POWER DOWN to OFF-AUTO POWER DOWN.

I can't connect a slave to Group play.

- After 1 hour, the host will block any additional slaves from being added. Press the **GROUP PLAY** button on host, after it display "**HOST**" message, the slave can be reconnected.

It cannot make a "Wireless/Wired Group/Add Stereo/Bluetooth" connection.

Is the distance between systems too far?

- It is recommended to make a "Wireless/Wired Group/Add Stereo/Bluetooth" pairing within 1 meter from the system.
- The recommended operating distance between Party Audio systems is closer than 10 meters.

09 LICENCE



The Bluetooth® word mark and logos are registered trademarks owned by the Bluetooth SIG, Inc. and any use of such marks by Samsung Electronics Co., Ltd. is under license. Other trademarks and trade names are those of their respective owners.



Qualcomm aptX is a product of Qualcomm Technologies, Inc. and/or its subsidiaries. Qualcomm is a trademark of Qualcomm Incorporated, registered in the United States and other countries. aptX is a trademark of Qualcomm Technologies International, Ltd., registered in the United States and other countries.

10 OPEN SOURCE LICENCE NOTICE

To send inquiries and requests regarding open sources, contact Samsung via Email (oss.request@samsung.com).

11 IMPORTANT NOTES ABOUT SERVICE

- Figures and illustrations in this User Manual are provided for reference only and may differ from actual product appearance.
- An administration fee may be charged if either
 - (a) an engineer is called out at your request and there is no defect with the product (i.e. where the user manual has not been read).
 - (b) you bring the unit to a repair centre and there is no defect with the product (i.e. where the user manual has not been read).
- You will be informed of the administration fee amount before a technician visits.

12 SPECIFICATIONS AND GUIDE

Specifications

Model Name		MX-T70
USB1/USB2		USB1: 5V/2.1A USB2: 5V/0.5A
Weight		26.5 kg
Dimensions (W x H x D)		463.0 x 884.0 x 455.0 mm
Operating Temperature Range		+5°C to +35°C
Operating Humidity Range		10 % ~ 75 %
AMPLIFIER Rated Output power	Tweeter	150W x 2, 12 ohm
	Middle	300W x 2, 6 ohm
	Woofers	600W x 1, 3 ohm
WIRELESS DEVICE OUTPUT POWER BT max transmitter power		100mW at 2.4GHz – 2.4835GHz
Overall Standby Power Consumption (W)		2.0W
Bluetooth Port deactivation method		Press and hold the BASS button for more than 5 seconds to turn off Bluetooth Power function.

NOTES

- Samsung Electronics Co., Ltd reserves the right to change the specifications without notice.
- Weight and dimensions are approximate.

- Hereby, Samsung Electronics, declares that this equipment is in compliance with Directive 2014/53/EU.



The full text of the EU declaration of conformity is available at the following internet address: <http://www.samsung.com> go to Support > Search Product Support and enter the model name.

This equipment may be operated in all EU countries.



[Correct disposal of batteries in this product]

(Applicable in countries with separate collection systems)

This marking on the battery, manual or packaging indicates that the batteries in this product should not be disposed of with other household waste at the end of their working life. Where marked, the chemical symbols Hg, Cd or Pb indicate that the battery contains mercury, cadmium or lead above the reference levels in EC Directive 2006/66.

If batteries are not properly disposed of, these substances can cause harm to human health or the environment.

To protect natural resources and to promote material reuse, please separate batteries from other types of waste and recycle them through your local, free battery return system.



Correct Disposal of This Product (Waste Electrical & Electronic Equipment)

(Applicable in countries with separate collection systems)

This marking on the product, accessories or literature indicates that the product and its electronic accessories (e.g. charger, headset, USB cable) should not be disposed of with other household waste at the end of their working life. To prevent possible harm to the environment or human health from uncontrolled waste disposal, please separate these items from other types of waste and recycle them responsibly to promote the sustainable reuse of material resources.

Household users should contact either the retailer where they purchased this product, or their local government office, for details of where and how they can take these items for environmentally safe recycling.

Business users should contact their supplier and check the terms and conditions of the purchase contract. This product and its electronic accessories should not be mixed with other commercial wastes for disposal.

For information on Samsung's environmental commitments and product specific regulatory obligations e.g. REACH, WEEE, Batteries, visit:

http://www.samsung.com/uk/aboutsamsung/samsungelectronics/corporatecitizenship/data_corner.html



UNITED KINGDOM



EIRE

This Samsung product is warranted for the period of twelve (12) months from the original date of purchase, against defective materials and workmanship. In the event that warranty service is required, you should return the product to the retailer from whom it was purchased. However, Samsung Authorised Dealers and Authorised Service Centres in other EC Countries will comply with the warranty on the terms issued to purchasers in the country concerned. In case of difficulty, details of our Authorised Service Centres are available from:

Samsung Electronics U.K. Ltd
Samsung Customer Support Centre
Selectapost 38, Sheffield, S97 3FJ
United Kingdom

United Kingdom
Tel : 0330 SAMSUNG (7267864)
www.samsung.com/uk/support

EIRE
Tel : 0818 717100
www.samsung.com/ie/support

■ WARRANTY CONDITIONS

1. The warranty is only valid if, when warranty service is required, the warranty card is fully and properly completed and is presented with the original invoice or sales slip or confirmation, and the serial number on the product has not been defaced.
2. Samsung's obligations are limited to the repair or, at its discretion, replacement of the product or the defective part.
3. Warranty repairs must be carried out by Authorised Samsung Dealers or Authorised Service Centres. No re-imbusement will be made for repairs carried out by non Samsung Dealers and, any such repair work and damage to the products caused by such repair work will not be covered by this warranty.
4. This product is not considered to be defective in materials nor workmanship by reason that it requires adaptation in order to conform to national or local technical or safety standards in force in any Country other than the one for which the product was originally designed and manufactured. This warranty will not cover, and no re-imbusement will be made for such adaptation nor any damage which may result.
5. This warranty covers none of the following:
 - a) Periodic check ups, maintenance and repair or replacement of parts due to normal wear and tear.
 - b) Cost relating to transport, removal or installation of the product.
 - c) Misuse, including the failure to use this product for its normal purposes or incorrect installation.
 - d) Damage caused by Lightning, Water, Fire, Acts of God, War, Public Disturbances, incorrect mains voltage, improper ventilation or any other cause beyond the control of Samsung.
6. This warranty is valid for any person who legally acquired possession of the product during the warranty period.
7. The consumers statutory rights in any applicable national legislation whether against the retailer arising from the purchase contract or otherwise are not affected by this warranty. Unless there is national legislation to the contrary, the rights under this warranty are the consumers sole rights and Samsung, its subsidiaries and distributors shall not be liable for indirect or consequential loss or any damage to records, compact discs, videos or audio taper or any other related equipment or material.

SAMSUNG ELECTRONICS (U.K.) LTD.

© 2019 Samsung Electronics Co., Ltd. All rights reserved.

Contact SAMSUNG WORLD WIDE

If you have any questions or comments relating to Samsung products, please contact the SAMSUNG customer care Centre.

Area	Contact Centre ☎	Web Site	Area	Contact Centre ☎	Web Site
Europe			CZECH	800 - SAMSUNG (800-726786)	www.samsung.com/cz/support
UK	0330 SAMSUNG (7267864)	www.samsung.com/uk/support	SLOVAKIA	0800 - SAMSUNG (0800-726 786)	www.samsung.com/sk/support
IRELAND (EIRE)	0818 717100	www.samsung.com/ie/support	CROATIA	072 726 786	www.samsung.com/hr/support
GERMANY	0619677 55577	www.samsung.com/de/support	BOSNIA	055 233 999	www.samsung.com/support
FRANCE	01 48 63 00 00	www.samsung.com/fr/support	NORTH MACEDONIA	023 207 777	www.samsung.com/mk/support
ITALIA	800-SAMSUNG (800.7267864)	www.samsung.com/it/support	MONTENEGRO	020 405 888	www.samsung.com/support
SPAIN	91175 00 15	www.samsung.com/es/support	SLOVENIA	080 697 267 (brezplačna številka)	www.samsung.com/si/support
PORTUGAL	808 207 267	www.samsung.com/pt/support	SERBIA	011 321 6899	www.samsung.com/rs/support
LUXEMBURG	261 03 710	www.samsung.com/be_fr/support	ALBANIA	045 620 202	www.samsung.com/al/support
NETHERLANDS	088 90 90 100	www.samsung.com/nl/support	BULGARIA	*3000 Цена на един градски разговор 0800 111 311 Безплатен за всички оператори	www.samsung.com/bg/support
BELGIUM	02-201-24-18	www.samsung.com/be/support (Dutch) www.samsung.com/be_fr/support (French)	ROMANIA	*8000 (apel în rețea) 08008-726-78-64 (08008-SAMSUNG) Apel GRATUIT Atenție: Dacă efectuați apelul din rețeaua Digi (RCS/RDS), vă rugăm să ne contactați formând numărul Telverde fără ultimele două cifre, astfel: 0800872678.	www.samsung.com/ro/support
NORWAY	21629099	www.samsung.com/no/support	CYPRUS	8009 4000 only from landline, toll free	www.samsung.com/gr/support
DENMARK	707 019 70	www.samsung.com/dk/support	GREECE	80111-SAMSUNG (80111 726 7864) only from land line (+30) 210 6897691 from mobile and land line	www.samsung.com/lt/support
FINLAND	030-6227515	www.samsung.com/fi/support	LITHUANIA	8-800-77777	www.samsung.com/lv/support
SWEDEN	0771 726 786	www.samsung.com/se/support	LATVIA	8000-7267	www.samsung.com/ee/support
POLAND	801-172-678* lub +48 22 607-93-33* Specjalistyczna infolinia do obsługi zapytań dotyczących telefonów komórkowych: 801-672-678* * (opłata według taryfy operatora)	http://www.samsung.com/pl/support/	ESTONIA	800-7267	www.samsung.com/ee/support
HUNGARY	0680SAMSUNG (0680-726-7864)	www.samsung.com/hu/support			
AUSTRIA	0800 72 67 864 (0800-SAMSUNG)	www.samsung.com/at/support			
SWITZERLAND	0800 726 786 (0800-SAMSUNG)	www.samsung.com/ch/support (German) www.samsung.com/ch_fr/support (French)			