



User Guide



HP Neverstop Laser 1000 series

Copyright and License

© Copyright 2020 HP Development Company, L.P.

Reproduction, adaptation, or translation without prior written permission is prohibited, except as allowed under the copyright laws.

The information contained herein is subject to change without notice.

The only warranties for HP products and services are set forth in the express warranty statements accompanying such products and services. Nothing herein should be construed as constituting an additional warranty. HP shall not be liable for technical or editorial errors or omissions contained herein.

Trademark Credits

Apple and the Apple logo are trademarks of Apple Inc., registered in the U.S. and other countries.

OS X is a trademark of Apple Inc., registered in the U.S. and other countries.

AirPrint is a trademark of Apple Inc., registered in the U.S. and other countries.

iPhone is a trademark of Apple Inc., registered in the U.S. and other countries.

Microsoft® and Windows® are U.S. registered trademarks of Microsoft Corporation.

Amazon, Kindle, and all related logos are trademarks of Amazon.com, Inc. or its affiliates.

Wi-Fi and Wi-Fi Direct are registered trademarks of the Wi-Fi Alliance. (See <https://www.wi-fi.org/who-we-are/our-brands> for more details.)

Table of contents

1 Get started	1
Printer views	2
Printer front view	2
Printer back view	2
Control panel features	3
Base models	3
Wireless models	4
Use the HP Smart app to print, copy, scan, and troubleshoot	6
2 Connect your printer	7
Connect to a wireless network with a router	8
Connect your printer to a wireless network using Wi-Fi Protected Setup (WPS)	8
Connect your printer to a wireless network using HP printer software	8
Connect wirelessly without a router	9
Wireless settings	12
Connect to a wired (Ethernet) network	13
3 Configure your printer	15
Configure the printer using the HP Embedded Web Server (EWS) and HP Device Toolbox (Windows)	16
Accessing and Using the Embedded Web Server (EWS)	16
Opening the HP Embedded Web Server (EWS) from the software (Windows 7)	16
Opening the HP Embedded Web Server (EWS) from a web browser	16
Opening the HP Embedded Web Server (EWS) when using a Wi-Fi Direct connection ..	17
Navigating the HP Embedded Web Server	17
Configure IP network settings	19
View or change network settings	19
Rename the printer on a network	19
Manually configure IPv4 TCP/IP parameters	19
Assign or change the system password using the HP Embedded Web Server	19
Change energy-conservation settings	20
Set the Sleep/Auto Off After Inactivity setting	20

Set the Shut Down After Inactivity delay and configure the printer to use 1 watt or less of power	20
Set the Delay Shut Down setting	21
Update the firmware	22
Update the firmware using the Firmware Update Utility	22
Change the printer connection type (Windows 7)	23
4 Load media	25
Configure the input tray for different paper sizes	25
Load paper	27
Load and print envelopes	30
Load and print labels	32
5 Print	35
Print using a Windows computer	36
Select the paper type (Windows)	36
Manually print on both sides (Windows)	37
Print multiple pages per sheet (Windows)	37
Print using a Mac computer	38
Print with mobile devices	39
6 Manage toner, media, and parts	41
Check the toner level	42
Reload toner	43
Replace the imaging drum	46
Order supplies, media, and parts	48
7 Solve problems	49
HP support	50
Contact HP	50
Register printer	50
Additional warranty options	50
Additional information	51
Interpret control-panel light patterns	52
Restore the factory-set defaults	55
Printer does not pick up paper or misfeeds	56
Introduction	56
The product does not pick up paper	56
The product picks up multiple sheets of paper	56
Clear paper jams	57

Introduction	57
Jam locations	57
Frequent or recurring paper jams	58
Clear jams from the input tray	59
Clear jams from inside the product	61
Clear jams from the output areas	62
Improve print quality	63
Introduction	63
Reprint the document	63
Check the toner level	63
Update the printer firmware	63
Print from a different software program	63
Check the paper type and print quality settings for the print job	63
Check the paper type loaded in the printer	64
Check the paper type and print quality settings (Windows)	64
Check the paper type and print quality settings (OS X)	64
Visually inspect the imaging drum	65
Check paper and the printing environment	65
Step one: Use paper that meets HP specifications	65
Step two: Check the environment	65
Adjust Print Density	66
Resolving print quality problems	67
Solve wireless network problems	72
Introduction	72
Wireless connectivity checklist	72
Perform a wireless network diagnostic test	73
The printer does not print after the wireless configuration completes	73
The printer does not print, and the computer has a third-party firewall installed	74
The wireless connection does not work after moving the wireless router or printer	74
Cannot connect more devices to the wireless printer (Wi-Fi Direct)	74
The wireless printer loses communication when connected to a VPN	74
The network does not appear in the wireless networks list	75
The wireless network is not functioning	75
Reduce interference on a wireless network	75
Solve Ethernet connection problems	77
Appendix A Printer specifications	79
Technical specifications	79
Supported operating systems	79
Printer dimensions	81
Power consumption, electrical specifications, and acoustic emissions	81

Operating-environment range	81
Warning icons	82
Laser Warning	83

Appendix B Service and support 85

HP limited warranty statement	86
UK, Ireland, and Malta	88
Austria, Belgium, Germany, and Luxemburg	88
Belgium, France, and Luxemburg	89
Italy	90
Spain	90
Denmark	91
Norway	91
Sweden	91
Portugal	92
Greece and Cyprus	92
Hungary	92
Czech Republic	93
Slovakia	93
Poland	93
Bulgaria	94
Romania	94
Belgium and the Netherlands	94
Finland	95
Slovenia	95
Croatia	95
Latvia	95
Lithuania	96
Estonia	96
Russia	96
HP's Premium Protection Warranty: Neverstop Toner Reload Kit and HP Laser Imaging Drum limited warranty statement	97
HP policy on non-HP supplies	98
HP anticounterfeit Web site	98
Data stored on the HP Toner Reload Kit and the HP Laser Imaging Drum	99
End User License Agreement	100
Customer self-repair warranty service	105
Customer support	106

Appendix C Environmental product stewardship program 107

Protecting the environment	108
----------------------------------	-----

Ozone production	108
Power consumption	108
Paper use	109
Plastics	109
HP Neverstop printing supplies	109
Paper	109
Material restrictions	109
Battery information	110
Disposal of waste equipment by users (EU and India)	111
Electronic hardware recycling	111
Hardware recycling information (Brazil)	112
Chemical substances	112
Product Power Data per European Union Commission Regulation 1275/2008	112
SEPA Ecolabel User Information (China)	113
The regulation of the implementation on China energy label for printer, fax, and copier	113
Restriction of Hazardous Substances statement (India)	113
WEEE (Turkey)	113
The Table of Hazardous Substances/Elements and their Content (China)	114
Material Safety Data Sheet (MSDS)	114
EPEAT	115
Declaration of the Presence Condition of the Restricted Substances Marking (Taiwan)	116
For more information	118

Appendix D Regulatory information 119

Regulatory statements	120
European Union Regulatory Notice	120
Regulatory model identification numbers	120
FCC regulations	120
Canada - Industry Canada ICES-003 Compliance Statement	120
Power cord instructions	121
Laser safety	121
Laser statement for Finland	122
Nordic Statements (Denmark, Finland, Norway, Sweden)	122
Eurasian Conformity (Armenia, Belarus, Kazakhstan, Kirgizstan, Russia)	123
Производитель и дата производства	123
Өндіруші және өндіру мерзімі	123
Местные представители	123
Жергілікті өкілдіктері	123
Wireless statements	124
FCC compliance statement—United States	124
Brazil ANATEL statement	124

Canadian statements	124
Products with 5 GHz Operation Industry of Canada	124
Exposure to Radio Frequency Radiation (Canada)	124
European Union regulatory notice	125
Notice for use in Russia	125
Mexico statement	125
Vietnam Telecom wired/wireless marking for ICTQC Type approved products	125

Index	127
--------------------	------------

1 Get started

- [Printer views](#)
- [Control panel features](#)
- [Use the HP Smart app to print, copy, scan, and troubleshoot](#)

Printer views

- [Printer front view](#)
- [Printer back view](#)

Printer front view

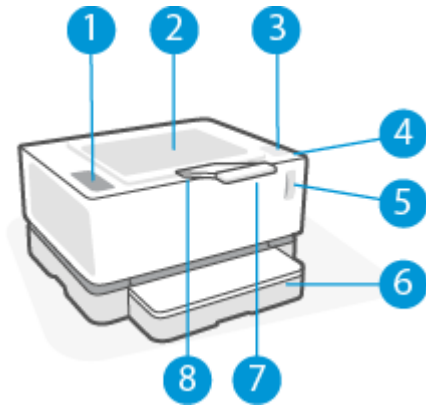

1	Control panel
2	Output bin
3	Reload port
4	Reload Status light
5	Toner level indicator
6	Input tray
7	Output bin extension
8	Finger recess

Printer back view

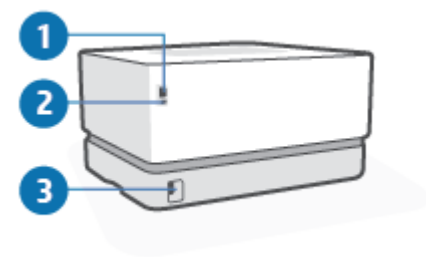





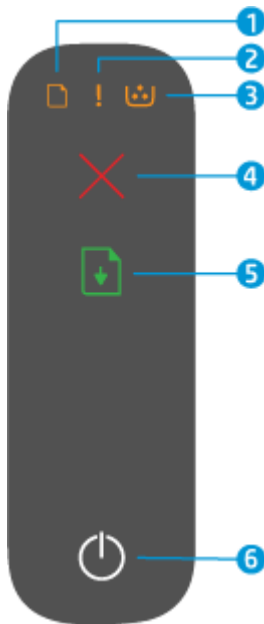

1	Ethernet network port (Ethernet models only)
2	USB port
3	Power connection

Control panel features







Base models

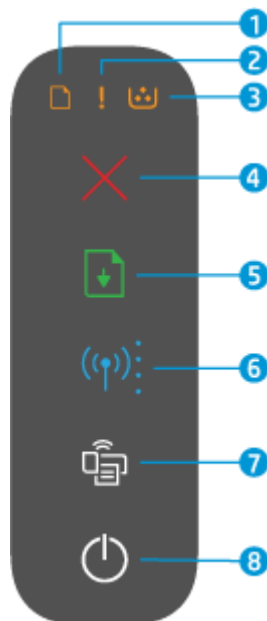



1	Paper light 	When you start a print or copy job, the Paper light blinks if the input tray is out of paper. The light turns on (solid) when there is a paper error.
2	Attention light 	The Attention light blinks when the printer requires user attention. If the Attention light is on solid, there is a service error.
3	Imaging Drum light 	When this light is on (solid), it indicates that the imaging drum is nearing the end of its useful life, or, if the Attention light is blinking at the same time, that there is a problem with the imaging drum. If the Imaging Drum light blinks, you must replace the imaging drum to continue printing.
4	Cancel button 	Press this button to cancel a job.
5	Resume button 	Press this button for the following actions: <ul style="list-style-type: none">• If the printer is in a error or prompt state, with the Resume light on, press the button to clear the error and resume printing.• In manual duplex mode, press this button to print the second side of the document.• Press and hold this button for 3 seconds to print a configuration page.
6	Power button/Ready light 	Use this button to turn the printer on or off. The Ready light is on when the printer is ready to print. It blinks when the printer is receiving print data and dims when the printer is in Sleep mode.

Wireless models



1	Paper light 	The Paper light blinks when the input tray is out of paper, and is on (solid) when there is a paper error.
2	Attention light 	The Attention light blinks when the printer requires user attention. If the Attention light is on solid, there is a service error.
3	Imaging Drum light 	When this light is on (solid), it indicates that the imaging drum is nearing the end of its useful life, or, if the Attention light is blinking at the same time, that there is a problem with the imaging drum. If the Imaging Drum light blinks, you must replace the imaging drum to continue printing.
4	Cancel button 	Press this button to cancel a job.
5	Resume button 	Press this button for the following actions: <ul style="list-style-type: none"> • If the printer is in a error or prompt state, with the Resume light on, press the button to clear the error and resume printing. • In manual duplex mode, press this button to print the second side of the document. • Press and hold this button for 3 seconds to print a configuration page.
6	Wireless button and light 	Press this button to turn the wireless feature on or off. Press and hold this button to configure a WPS connection. If the Wireless button light glows steady blue, there is a stable wireless connection. If it is blinking blue, the printer is in wireless connection setup mode or WPS configuration is in progress. If the light glows amber, the printer cannot connect to the wireless network, or there is a WPS error.

7	Wi-Fi Direct button		Press this button to turn Wi-Fi Direct on or off. Press this button to complete a Wi-Fi Direct connection if it is blinking.
8	Power button/Ready light		Use this button to turn the printer on or off. The Ready light is on when the printer is ready to print. It blinks when the printer is receiving print data and dims when the printer is in Sleep mode.

Use the HP Smart app to print, copy, scan, and troubleshoot

HP Smart helps you to set up, copy, scan, print, share, and manage your HP printer. You can share documents and images through email, text messages, and popular cloud and social media services (such as iCloud, Google Drive, Dropbox, and Facebook). You can also set up new HP printers, as well as monitor and order supplies.

The HP Smart app is compatible with the following mobile device and computer operating systems:

- iOS
- Android
- Windows 10
- Mac OS X 10.11 and later



NOTE: The HP Smart app might not be available in all languages. Some features might not be available with all printer models.

To install the HP Smart app

- ▲ To install the app on your device, go to 123.hp.com and follow the onscreen instructions to access your device's app store.

To open the HP Smart app on a Windows 10 computer

- ▲ After installing the HP Smart app, from the device desktop, click **Start**, and then select **HP Smart** from the app list.

Connect to your printer

- ▲ Make sure that your device is connected to the same network as the printer. Then HP Smart will automatically detect the printer.

Get more information about the HP Smart app

For more information about using HP Smart for printing, accessing printer features, and troubleshooting issues, go to:

- **iOS/Android:** www.hp.com/go/hpsmart-help
- **Windows 10:** www.hp.com/go/hpsmartwin-help
- **Mac:** <http://www.hp.com/go/hpsmartmac-help>

2 Connect your printer

- [Connect to a wireless network with a router](#)
- [Wireless settings](#)
- [Connect to a wired \(Ethernet\) network](#)

The most up-to-date information for connecting your printer, and troubleshooting connection issues is available online from the HP Support sites. For example, the following topics can be found there:

- Learn more about configuring your network and the printer for wireless printing. [Click here for more information.](#)
- Learn how to find your network security settings. [Click here to go online for more information.](#)
- Learn about the HP Print and Scan Doctor. [Click here for more information.](#)



NOTE: This utility is only available for Windows operating system.

- Use the [HP online firewall troubleshooter](#) to determine if a firewall or antivirus program is preventing your computer from connecting to the printer and find resolutions.

Connect to a wireless network with a router

 **NOTE:** This section is applicable to wireless printer models only.

 **NOTE:** Before proceeding with this section, check that your printer is not connected to your computer with a USB or Ethernet cable. NO

Connect your printer to a wireless network using Wi-Fi Protected Setup (WPS)

Before you can connect your printer to a wireless network using WPS, make sure you have the following:

- A wireless 802.11b/g/n network that includes a WPS-enabled wireless router or access point.

 **NOTE:** The printer only supports connections using 2.4 GHz.

- A computer connected to the wireless network that you intend to connect the printer to. Be sure you have installed the HP printer software on the computer.

If you have a WPS router with a WPS push button, follow the **Push Button method**.

To use the Push Button Configuration (PBC) method

1. Press and hold the Wireless button () for at least three seconds to start WPS Push Button method.
2. Press the WPS button on your router.

 **NOTE:** The product begins a timer for approximately two minutes while a wireless connection is established.

Connect your printer to a wireless network using HP printer software

To connect the printer to an integrated wireless WLAN 802.11 network, you will need the following:

- A wireless 802.11b/g/n network that includes a wireless router or access point.

 **NOTE:** The printer only supports connections using 2.4 GHz.

- A computer connected to the wireless network that you intend to connect the printer to.
- Network name (SSID).
- WEP key or WPA Passphrase (if needed).

To connect your printer using HP printer software

1. Depending on whether you have installed the HP printer software or not, do one of the following:

If you have not installed the HP printer software on your computer

- a. Visit www.support.hp.com to download and install the printer software.
- b. Follow the onscreen instructions.

If you have the HP printer software installed on your computer

- a. Open the printer software.
- b. In the printer software, click **Tools**.

- c. Click **Device Setup & Software**.
 - d. Click **Connect a new device**, and then follow the onscreen instructions.
2. After the printer connects successfully, the Wireless button  glows blue.

Connect wirelessly without a router

 **NOTE:** This section is applicable to wireless printer models only.

 **NOTE:** Before proceeding with this section, check that your printer is not connected to your computer with a USB or Ethernet cable.

With Wi-Fi Direct, you can print wirelessly from a computer, smart phone, tablet, or other wireless-capable device—without connecting to an existing wireless network.

Guidelines for using Wi-Fi Direct

- Make sure your computer or mobile device has the necessary software.
 - If you are using a computer, make sure you have installed the HP printer software.

If you have not installed the HP printer software on the computer, connect to Wi-Fi Direct first and then install the printer software. Select **Wireless** when prompted by the printer software for a connection type.
 - If you are using a mobile device, make sure you have installed a compatible printing app. For more information, visit the HP Mobile Printing website at www.hp.com/go/mobileprinting. If a local version of this website is not available in your country/region or language, you might be directed to the HP Mobile Printing website in another country/region or language.
- Make sure Wi-Fi Direct for your printer is turned on.
- Up to five computers and mobile devices can use the same Wi-Fi Direct connection.
- Wi-Fi Direct can be used regardless of whether the printer is connected to a network using a wireless connection or not.
- Wi-Fi Direct cannot be used to connect a computer, mobile device, or printer to the Internet.
- To learn more about setting up a Wi-Fi Direct connection, visit www.hp.com/go/wpc-wirelessdirect.

To turn Wi-Fi Direct on or off from the control panel

- ▲ On the printer control panel, press the Wi-Fi Direct button .

When Wi-Fi Direct is turned on, the Wi-Fi Direct button  glows steady white.

Wi-Fi Direct connection security setting

- If the Wi-Fi Direct connection security for the printer is **Automatic**, the Wi-Fi Direct password is set to 12345678 and cannot be changed.
- If the Wi-Fi Direct connection security for the printer is set to **Manual**, you need to do one of the following to connect to the printer on your mobile device or computer.

- If the Wi-Fi Direct button  is blinking, press it.
- If the printer prints out a page with a PIN code, use the PIN to complete the connection to the device.

 **TIP:**

- You can also turn on Wi-Fi Direct or change the Wi-Fi Direct connection security setting from the EWS.
 - To find the Wi-Fi Direct name and password, press and hold the Resume button  on the printer for 3 seconds to print a Configuration Report.
-

To print from a wireless-capable mobile device that supports Wi-Fi Direct

 **NOTE:** Available wireless connection methods vary depending on the operating system of your mobile device. For more information, visit www.hp.com/go/wpc-wirelessdirect .

Make sure you have installed the latest version of HP Print Service Plugin on your mobile device (if using an Android device). You can download this plugin from the Google Play application store.

1. Make sure you have turned on Wi-Fi Direct on the printer.
2. Turn on Wi-Fi Direct on your mobile device. For more information, see the documentation provided with the mobile device.
3. From your mobile device, select a document from a print enabled application, and then select the option to print the document.

The list of available printers appears.

4. From the list of available printers, choose the Wi-Fi Direct name.
5. Print your document.

To print from a wireless-capable mobile device that does not support Wi-Fi Direct

 **NOTE:** Available wireless connection methods vary depending on the operating system of your mobile device. For more information, visit www.hp.com/go/wpc-wirelessdirect .

Make sure you have installed a compatible printing app on your mobile device. For more information, visit the HP Mobile Printing website at www.hp.com/go/mobileprinting. If a local version of this website is not available in your country/region or language, you might be directed to the HP Mobile Printing website in another country/region or language.

1. Make sure you have turned on Wi-Fi Direct on the printer.
2. Turn on the Wi-Fi connection on your mobile device. For more information, see the documentation provided with the mobile device.

 **NOTE:** If your mobile device does not support Wi-Fi, you are not able to use Wi-Fi Direct.

3. From the mobile device, connect to a new network. Use the process you normally use to connect to a new wireless network or hotspot. Choose the Wi-Fi Direct name from the list of wireless networks shown. The network name is based on the name of your printer.

Enter the Wi-Fi Direct password when prompted.

4. Print your document.

To print from a wireless-capable computer

1. Make sure you have turned on Wi-Fi Direct on the printer.
2. Turn on the computer's Wi-Fi connection. For more information, see the documentation provided with the computer.



NOTE: If your computer does not support Wi-Fi, you are not able to use Wi-Fi Direct.

3. From the computer, connect to a new network. Use the process you normally use to connect to a new wireless network or hotspot. Choose the Wi-Fi Direct name from the list of wireless networks shown. The network name is based on the name of your printer.

Enter the Wi-Fi Direct password when prompted.

4. Print your document.



Wireless settings

 **NOTE:** This section is applicable to wireless printer models only.



 **NOTE:** Before proceeding with this section, check that your printer is not connected to your computer with a USB or Ethernet cable.

To turn on or off the wireless capability of the printer

Press the Wireless button  to turn on or off the printer wireless capabilities.

- If the printer has an active connection to a wireless network, the Wireless button  is blue.
- If wireless is turned off, the Wireless button  will not be lit.

To restore network settings to default settings

- Press and hold the Wireless button  and the Cancel button  at the same time for at least three seconds. The printer restarts and then the Wireless light  starts blinking blue, indicating the printer is in Auto Wireless Connect (AWC) setup mode. You can now set up a wireless connection between the printer and your device.

Connect to a wired (Ethernet) network



NOTE: This section is applicable to Ethernet printer models only.

1. Make sure you have a network router with available Ethernet ports.
2. Make sure your computer is connected to the router.
3. Connect an Ethernet cable to the Ethernet port  on the back of the printer.
4. Connect the other end of the Ethernet cable to an available port on the router.
5. Go to 123.hp.com to download the printer software.
6. Run the software to complete the setup.

3 Configure your printer

- [Configure the printer using the HP Embedded Web Server \(EWS\) and HP Device Toolbox \(Windows\)](#)
- [Update the firmware](#)
- [Change the printer connection type \(Windows 7\)](#)

Configure the printer using the HP Embedded Web Server (EWS) and HP Device Toolbox (Windows)

Use the HP Embedded Web Server to manage printing functions from your computer.

- View printer status information
- Determine the remaining life for all supplies and order new ones
- Receive notification of printer and supplies events
- View and change network configuration

The HP Embedded Web Server works when the printer is connected to your computer via an IP-based network or USB. The HP Embedded Web Server does not support IPX-based printer connections. You do not have to have Internet access to open and use the HP Embedded Web Server.

When the printer is connected to the network, you can connect to the HP Embedded Web Server directly, and it is automatically available.

When the printer is connected via USB (not connected to the network) you use the HP Device Toolbox software to connect to the HP Embedded Web Server.

 **NOTE:** If the printer is connected to a Windows computer via USB, you must use the HP Device Toolbox software application to connect to the HP Embedded Web Server (EWS). HP Device Toolbox is available only if you installed the full printer software. Depending on how the printer is connected, some features might not be available. If the printer is connected to a Windows computer via a network, or to a Mac computer, additional software is not needed to connect to the EWS.

 **NOTE:** The HP Embedded Web Server is not accessible beyond the network firewall.

Accessing and Using the Embedded Web Server (EWS)

The following sections provide instructions for accessing and navigating the HP Embedded Web Server.

Opening the HP Embedded Web Server (EWS) from the software (Windows 7)

 **NOTE:** HP Printer Assistant is part of the HP printer software for Windows 7 operating systems. Visit the [product support site](#) to find the software available for your printer and operating system.

1. Open the HP Printer Assistant.



From the computer desktop, click **Start**, select **All Programs**, click **HP**, click the folder for the printer, and then select the printer name.

2. In the HP Printer Assistant, select **Print**, and then select **HP Device Toolbox**.

Opening the HP Embedded Web Server (EWS) from a web browser

The following requires a network connection.

1. Print a configuration page to determine the IP address or host name.

- a. Press and hold the Resume button  for three seconds.
 - b. Release the Resume button .
2. Open a web browser, and in the address line, type the IP address or host name exactly as it displays on the printer configuration page. Press the Enter key on the computer keyboard. The EWS opens.

 **NOTE:** If the web browser displays a message indicating that accessing the website might not be safe, select the option to continue to the website. Accessing this website will not harm the computer.

Opening the HP Embedded Web Server (EWS) when using a Wi-Fi Direct connection

1. Set up a Wi-Fi Direct connection between your device and the printer.
2. Open a web browser, type the IP address 192 . 168 . 223 . 1 in the address line, and press the Enter key. The EWS opens.

 **NOTE:** If the web browser displays a message indicating that accessing the website might not be safe, select the option to continue to the website. Accessing this website will not harm the computer.

Navigating the HP Embedded Web Server

The table below provides a summary of the features available through the HP Embedded Web Server.

Table 3-1 HP Embedded Web Server Options

Tab or section	Description
Home tab Provides printer, status, and configuration information.	<ul style="list-style-type: none"> • Device Status: Shows the printer status and shows the approximate percent life remaining of HP supplies. • Supplies Status: Shows the approximate percent life remaining of HP supplies. Actual supply life remaining can vary. Consider having a replacement supply available to install when print quality is no longer acceptable. The supply does not need to be replaced unless the print quality is no longer acceptable. • Device Configuration: Shows the information found on the printer configuration page and other device configuration settings. • Network Summary: Shows the information found on the printer network configuration page and other network configuration settings. • Event Log: Shows a list of all printer events and errors. • Open Source Licenses: Shows a summary of the licenses for open source software programs that can be used with the printer.

Table 3-1 HP Embedded Web Server Options (continued)

Tab or section	Description
<p>System tab</p> <p>Provides the ability to configure the printer from your computer.</p>	<ul style="list-style-type: none">• Device Information: Provides basic printer and company information.• Paper Setup: Change the default paper-handling settings for the printer.• Energy Settings: Change the default times for entering Sleep/Auto Off mode or automatic shut down.• System Setup: Change the system defaults for the printer.• Service: Make adjustments for environmental factors such as humidity and altitude, control archive print mode, change the USB speed, and restore factory default settings.• Administration: Set or change the printer password, enable or disable PjL device access commands, specify signature check preference for firmware updates. <p>NOTE: The System tab can be password-protected. If this printer is on a network, always consult with the administrator before changing settings on this tab.</p>
<p>Networking tab</p> <p>(Network printer models only)</p> <p>Provides the ability to change network settings from your computer or mobile device.</p>	<p>Network administrators can use this tab to control network-related settings for the printer when it is connected to an IP-based network. It also allows the network administrator to set up Wireless Direct and Google Cloud Print functionality.</p> <p>NOTE: The Network tab can be password-protected. If this printer is on a network, always consult with the administrator before changing settings on this tab.</p>

Configure IP network settings

Use the following sections to configure the printer network settings.

View or change network settings

Use the HP Embedded Web Server to view or change IP configuration settings.

1. Open the HP Embedded Web Server (EWS).
2. Click the **Networking** tab to obtain network information. Change settings as needed.

Rename the printer on a network

To rename the printer on a network so that it can be uniquely identified, use the HP Embedded Web Server.

1. Open the HP Embedded Web Server (EWS).
2. Open the **System** tab.
3. On the **Device Information** page, the default printer name is in the **Device Description** field. You can change this name to uniquely identify this printer.



NOTE: Completing the other fields on this page is optional.

4. Click the **Apply** button to save the changes.

Manually configure IPv4 TCP/IP parameters

Use the EWS to manually set an IPv4 address, subnet mask, and default gateway.

1. Open the HP Embedded Web Server (EWS).
2. On the **Networking** tab, click **IPv4 Configuration** in the left navigation pane.
3. From the **IP Preferred Address Method** drop-down, select **Manual**, and then edit the IPv4 configuration settings.
4. Click the **Apply** button.

Assign or change the system password using the HP Embedded Web Server

Assign an administrator password for access to the printer and the HP Embedded Web Server so that unauthorized users cannot change the printer settings.

1. Open the HP Embedded Web Server (EWS).
2. On the **System** tab, click the **Administration** link in the left navigation pane.
3. In the area labeled **Product Security**, enter the password in the **Password** field.
4. Re-enter the password in the **Confirm Password** field.
5. Click the **Apply** button.



NOTE: Make note of the password and store it in a safe place.

Change energy-conservation settings

The printer includes several economy features to conserve energy and supplies.

Set the Sleep/Auto Off After Inactivity setting

Use the EWS to set the amount of idle time before the printer enters sleep mode.

Complete the following procedure to change the Sleep/Auto Off After Inactivity setting:

1. Open the HP Embedded Web Server (EWS).
 - Use the HP Smart app to access the EWS, if available.
 - Use the HP Printer Assistant for Windows 7 systems.
 - Press and hold the Resume button  to print a configuration page, then navigate to the IP address shown on the printer configuration page.

 **NOTE:** If you receive a message indicating that accessing the website might not be safe, select the option to continue to the website. Accessing this website will not harm the computer.

2. Click the **System** tab, and then select **Energy Settings**.
3. From the **Sleep/Auto Off After Inactivity** drop-down, select the time for the delay.
4. Click the **Apply** button.

Set the Shut Down After Inactivity delay and configure the printer to use 1 watt or less of power

Use the EWS to set the amount of time before the printer shuts down.

 **NOTE:** After the printer shuts down, the power consumption is 1 watt or less.

Complete the following procedure to change the Shut Down After Inactivity setting:

1. Open the HP Embedded Web Server (EWS).
 - Use the HP Smart app to access the EWS, if available.
 - Use the HP Printer Assistant for Windows 7 systems.
 - Press and hold the Resume button  to print a configuration page, then navigate to the IP address shown on the printer configuration page.

 **NOTE:** If you receive a message indicating that accessing the website might not be safe, select the option to continue to the website. Accessing this website will not harm the computer.

2. Click the **System** tab, and then select **Energy Settings**.
3. From the **Shut Down After Inactivity** drop-down, select the time for the delay.

 **NOTE:** The default value is **4 hours**.

4. Click the **Apply** button.

Set the Delay Shut Down setting

Use the EWS to select whether or not the printer delays shutting down after the Power button  is pressed.

Complete the following procedure to change the Delay Shut Down setting:

1. Open the HP Embedded Web Server (EWS).
 - Use the HP Smart app to access the EWS, if available.
 - Use the HP Printer Assistant for Windows 7 systems.
 - Press and hold the Resume button  to print a configuration page, then navigate to the IP address shown on the printer configuration page.

 **NOTE:** If you receive a message indicating that accessing the website might not be safe, select the option to continue to the website. Accessing this website will not harm the computer.

2. Click the **System** tab, and then select **Energy Settings**.
3. Select or clear the **Delay when ports are active** option.

 **NOTE:** When this option is selected the printer will not shut down unless all ports are inactive. An active network link will prevent the printer from shutting down.

Update the firmware

HP offers periodic printer updates. Follow these steps to update the printer firmware for a single printer.

Update the firmware using the Firmware Update Utility

Use these steps to manually download and install the Firmware Update Utility from HP.com.

 **NOTE:** This method is the only firmware update option available for printers connected to the computer via a USB cable. It also works for printers connected to a network.

 **NOTE:** You must have a print driver installed in order to use this method.

1. Go to www.hp.com/go/support, select your country/region or language, and then click the **Software and Drivers** link.
2. Type the printer name in the search field, press the Enter button, and then select the printer from the list of search results.
3. Select the operating system.
4. Under the **Firmware** section, locate the **Firmware Update Utility**.
5. Click **Download**, click **Run**, and then click **Run** again.
6. When the utility launches, select the printer from the drop-down list, and then click **Send Firmware**.

 **NOTE:** To print a configuration page to verify the installed firmware version before or after the update process, click **Print Config**.

7. Follow the on-screen instructions to complete the installation, and then click the **Exit** button to close the utility.

Change the printer connection type (Windows 7)

If you previously set up a USB, Ethernet, or wireless connection and now want to change the connection type, you can do so using the HP Printer Assistant software.



NOTE: To set up an Ethernet connection, you must have an Ethernet-capable printer model. To set up a wireless connection, you must have a wireless-capable printer model.



NOTE: HP Printer Assistant is part of the HP printer software for Windows 7 operating systems. Visit the [product support site](#) to find the software available for your printer and operating system.

1. Open the HP Printer Assistant.
 - From the computer desktop, click **Start**, select **All Programs**, click **HP**, click the folder for the printer, and then select the printer name.
2. In the HP Printer Assistant, select **Tools** from the navigation bar, and then select **Device Setup & Software**. Follow the on-screen instructions to set up the printer on your wireless network.
3. Follow the on-screen instructions for the type of connection you are setting up.

4 Load media

- [Configure the input tray for different paper sizes](#)
- [Load paper](#)
- [Load and print envelopes](#)
- [Load and print labels](#)

Configure the input tray for different paper sizes

 **NOTE:** This section is applicable only to printer models that support Legal and Oficio paper sizes.

Some printer models support Legal and Oficio paper sizes. If your printer model supports these paper sizes, you will need to change the orientation of the paper-length guide when you switch between large and small paper sizes.

To determine if your printer supports Legal/Oficio paper, compare the paper-length guide on your printer to the following images.

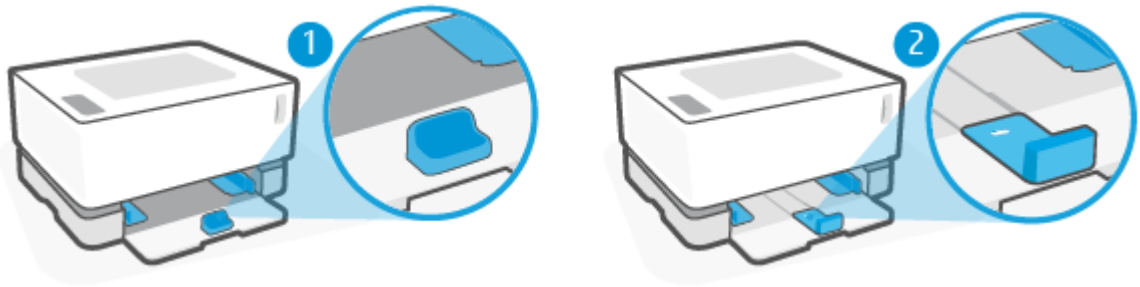

1	Printer does not support Legal/ Oficio paper.
2	Printer supports Legal/ Oficio paper.

Paper-guide orientation

- To load A4/Letter or larger paper, envelopes or labels, the paper-length guide must be in this orientation:

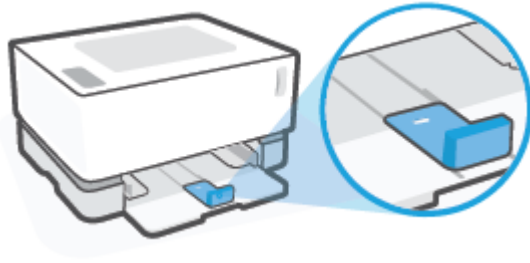

- To load paper smaller than A4/Letter, the paper-length guide must be in this orientation:

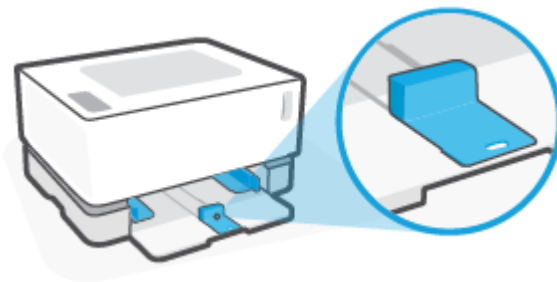

To turn the paper-length guide

1. Remove the input tray cover, if needed.

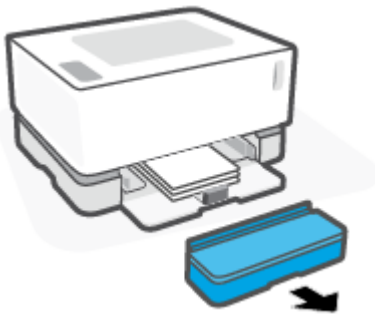

2. Remove all paper from the input tray.
3. Slide the paper-length guide to the outside edge of the input tray.

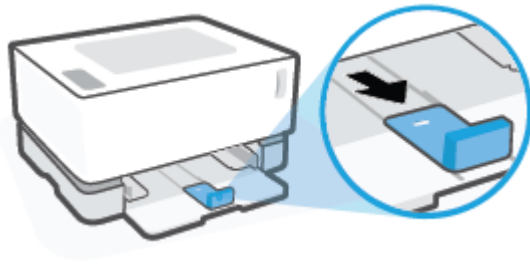



 **NOTE:** The guide is shown here in the correct orientation for A4/Letter or larger paper.

4. Tilt up the input tray slightly and pull it off the printer.

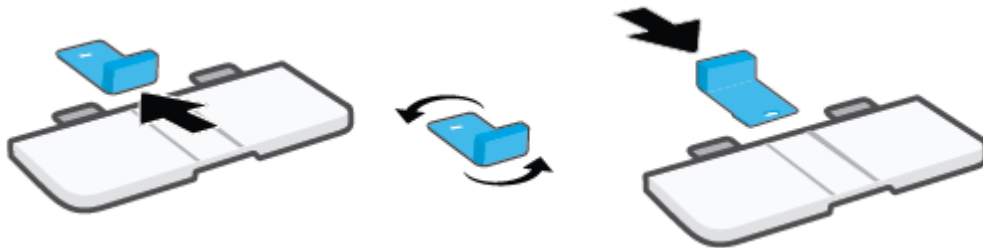

5. Slide the paper-length guide off the input tray, turn it around, and then slide it back onto the track in the tray.



 **NOTE:** The guide is shown being turned for loading paper smaller than A4/Letter. To load larger paper, turn the guide in the opposite direction.

6. Reinstall the input tray.

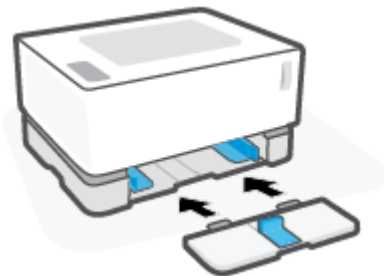

Load paper

The following information describes how to load paper into the input tray.

 **NOTE:** To avoid paper jams:

- Never add or remove paper from the input tray during printing.
 - Before loading the input tray, remove all of the paper from the input tray and straighten the stack.
 - Use paper that is not wrinkled, folded, or damaged.
-

To load paper

1. Remove the input tray cover.

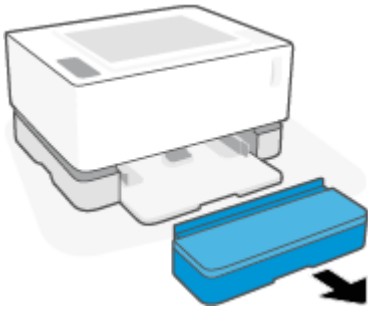

2. Remove paper from the input tray, if any.
3. Check that the paper-length guide is in the proper orientation for the paper size you are loading. For more information, see [Configure the input tray for different paper sizes on page 25](#).
4. Slide the paper guides outward to make room for the paper.

 **NOTE:** For Legal size paper, extend the paper-length guide off the edge of the tray and check that “LGL” shows in the window.

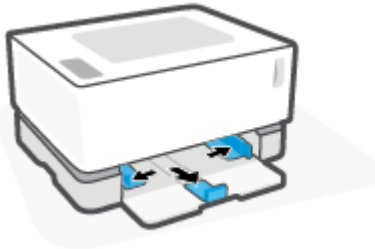

 **NOTE:** The paper-length guide is shown here in the proper orientation for A4/Letter or larger paper. To load smaller paper, the guide must be turned in the opposite direction. For more information, see [Configure the input tray for different paper sizes on page 25](#).

5. Flex or fan the edge of the paper stack to separate the pages before loading.

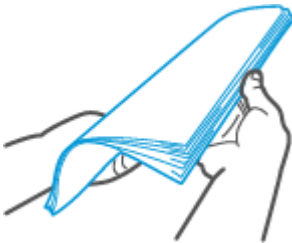

6. Insert the stack of paper into the input tray with the top forward and the side to be printed on facing up. Push the paper all the way in until it contacts the rear stop.

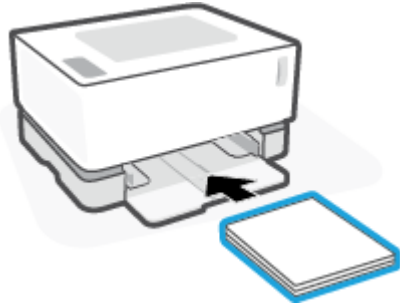

7. Slide the paper guides to the edges of the paper stack until they stop.

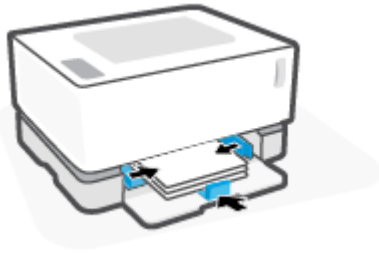

8. Reinstall the input tray cover.

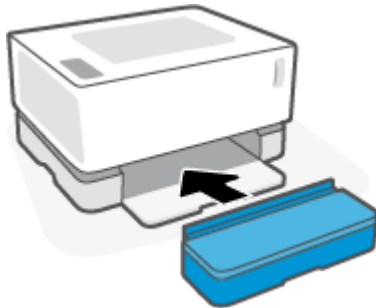

 **NOTE:** The cover cannot be used when paper larger than A4/Letter is loaded.

Load and print envelopes

To load envelopes

1. Remove the input tray cover.

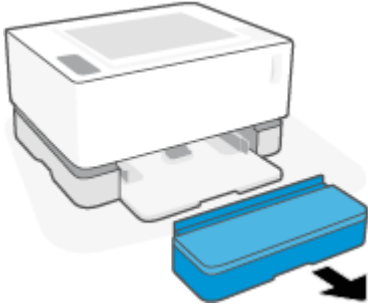

2. Slide the paper guides to the edges of the input tray.

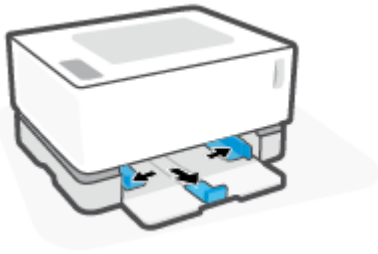

3. Remove all paper from the input tray.
4. Check that the paper-length guide is in the proper orientation for loading envelopes. For more information, see [Configure the input tray for different paper sizes on page 25](#).
5. Insert the envelope into the middle of the input tray, with the short, postage end toward the back of the tray. The side to be printed on should face up.
6. Slide the paper guides to the edges of the envelope until they stop.

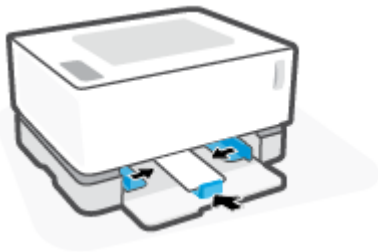

7. Reinstall the input tray cover.

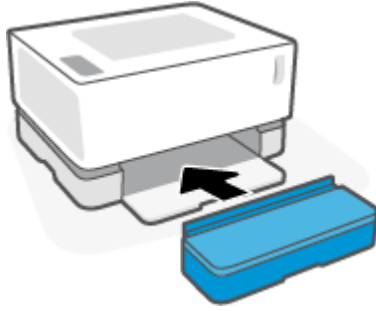

To print envelopes

1. From the software program, select the **Print** option.
2. Select the printer from the list of printers.
3. Click the button that opens the Properties dialog box. Depending on your software application, this button might be called **Properties**, **Preferences**, **Options**, **Printer Setup**, **Printer Properties**, or **Printer**.
4. Click or tap the **Paper/Quality** tab.
5. In the **Media** drop-down list, select **Envelope**.
6. Click the **OK** button to close the **Document Properties** dialog box.
7. In the **Print** dialog box, click the **OK** button to print the job.

Load and print labels

To load labels

1. Remove the input tray cover.

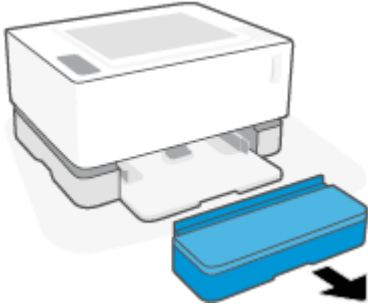

2. Slide the paper guides to the edges of the input tray.

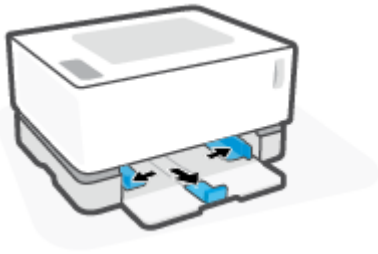

3. Remove all paper from the input tray.
4. Check that the paper-length guide is in the proper orientation for loading labels. For more information, see [Configure the input tray for different paper sizes on page 25](#).
5. Insert the sheet of labels into the middle of the input tray, with the top edge of the sheet toward the back of the tray. The side to be printed on should face up.



6. Slide the paper guides to the edges of the sheet until they stop.



7. Reinstall the input tray cover.

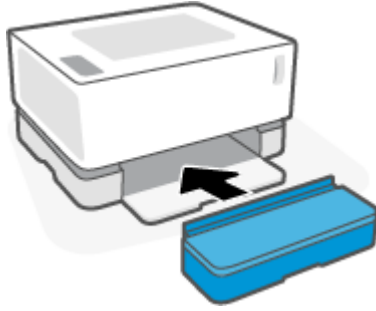

To print labels

1. From the software program, select the **Print** option.
2. Select the printer from the list of printers.
3. Click the button that opens the Properties dialog box. Depending on your software application, this button might be called **Properties**, **Preferences**, **Options**, **Printer Setup**, **Printer Properties**, or **Printer**.
4. Click the **Paper/Quality** tab.
5. In the **Media** drop-down list, select **Labels**.
6. Click the **OK** button to close the **Document Properties** dialog box.
7. In the **Print** dialog box, click the **OK** button to print the job.

5 Print

- [Print using a Windows computer](#)
- [Print using a Mac computer](#)
- [Print with mobile devices](#)



NOTE: When the Power light  is blinking and all other control panel lights are off, the printer is initializing, cooling down, performing automatic cleaning routines, or shutting down. When the printer is cooling down, print jobs might pause. Print jobs will continue when the engine is ready. This might take several minutes.

To provide productive printing, this printer may automatically enter cool down mode under certain environmental conditions when required.

Print using a Windows computer

The following procedure describes the basic printing process for Windows.

1. For wireless printing, make sure your printer is connected to the same network as your computer or device. If you want to print without connecting to a router, use Wi-Fi Direct.
2. From the software program, select the **Print** option.
3. Select the printer from the list of printers.
4. Click the button that opens the **Properties** dialog box.

Depending on your software application, this button might be called **Properties, Options, Printer Setup, Printer Properties, Printer,** or **Preferences.**

5. Click or tap the tabs in the print driver to configure the available options.
6. Click or tap the **OK** button to return to the **Print** dialog box. Select the number of copies to print from this screen.
7. Click or tap the **OK** button to print the job.

Select the paper type (Windows)

1. From the software program, select the **Print** option.
2. Select the printer from the list of printers.
3. Click the button that opens the **Properties** dialog box.

Depending on your software application, this button might be called **Properties, Options, Printer Setup, Printer Properties, Printer,** or **Preferences.**

4. Click or tap the **Printing Shortcuts** tab.
5. From the **Paper Type** drop-down list, select the correct paper type, and then click or tap the **OK** button to close the **Properties** or **Preferences** dialog box.
6. In the **Print** dialog box, click the **OK** button to print the job.

Manually print on both sides (Windows)

1. From the software program, select the **Print** option.
2. Select the printer from the list of printers.
3. Click the button that opens the **Properties** dialog box.

Depending on your software application, this button might be called **Properties, Options, Printer Setup, Printer Properties, Printer, or Preferences.**

4. Click the **Layout** tab.
5. Select the appropriate duplex option from the **Print on Both Sides Manually** drop-down list, and then click the **OK** button.
6. In the **Print** dialog box, click the **OK** button to print the job. The printer will print the first side of all the pages in the document first.
7. Retrieve the printed stack from the output bin, and place it with the printed-side facing down, top edge first in the input tray.
8. At the computer, click the **OK** button to print the second side of the job.
9. If prompted, select the appropriate control panel button to continue.

Print multiple pages per sheet (Windows)

1. From the software program, select the **Print** option.
2. Select the printer from the list of printers.
3. Click the button that opens the **Properties** dialog box.

Depending on your software application, this button might be called **Properties, Options, Printer Setup, Printer Properties, Printer, or Preferences.**

4. Click or tap the **Layout** tab.
5. Select the correct **Orientation** option.
6. Select the number of pages you want to print on each sheet from the **Pages per Sheet** option.
7. **Windows 7 only:** Click or tap the **Advanced** button.
8. Select how you want the pages to be arranged on each sheet from the **Pages per Sheet Layout** option.
9. **Windows 7 only:** Click or tap the **OK** button to close the **Advanced Options** dialog box.
10. Click or tap the **OK** button to close the **Properties** or **Preferences** dialog box.

Print using a Mac computer

Instructions for HP AirPrint-compatible printers and Mac computers with macOS and OS X 10.7 (Lion) and later.

You can print from a Mac computer that is running AirPrint as long as the printer is connected to the computer through a Wi-Fi network connection. When you use AirPrint, you do not need to download a driver to your computer.

To connect the printer

1. Connect the printer and the computer:
 - For wireless printing, verify that the printer has a good wireless connection and is connected to the same network as the computer.
 - For USB-connected printers, connect the printer to the computer via USB cable.
2. Open **System Preferences** on the computer, and select **Printers and Scanners**.
3. Click **(+)** and choose the printer from the displayed list of printers, and then click **Add**.

To print

- ▲ Once connected, use the Print command from your application or program to display the printing options. Select your printer from the list of printers available for your computer and applications. Refer to the documentation or help provided with your application for additional information.

Print with mobile devices

 **NOTE:** This section is applicable to wireless printer models only.

You can print documents and photos directly from your mobile devices, including iOS, Android, Windows Mobile, Chromebook and Amazon Kindle.

 **NOTE:** You can also use the HP Smart app to print from mobile devices.

1. Make sure your printer is connected to the same network as your mobile device. If you want to print without connecting to a router, use Wi-Fi Direct to print from a mobile device.

2. Enable printing on your mobile device:

- **iOS:** Use the **Print** option from the **Share** menu.

 **NOTE:** Devices running iOS 4.2 or later have AirPrint preinstalled.

- **Android:** Download the HP Print Service Plugin (supported by most Android devices) from the Google Play Store and enable it on your device.
- **Windows Mobile:** Tap **Print** from the **Device** menu.

 **NOTE:** If your printer is not listed, you might need to do a one-time setup of the printer using the **Add Printer** wizard.

- **Chromebook:** Download and install the **HP Print for Chrome** app from the Chrome Web Store to enable Wi-Fi printing.
- **Amazon Kindle Fire HD9 and HDX:** The first time you select **Print** on your device, the HP Print Service Plugin is automatically downloaded to enable mobile printing.

 **NOTE:** For detailed information about enabling printing from your mobile devices, visit the HP Mobile Printing website (www.hp.com/go/mobileprinting). If a local version of this website is not available in your country/region or language, you might be directed to the HP Mobile Printing website in another country/region or language.

3. Make sure the loaded paper matches the paper settings of the printer. Accurately setting the paper size for the paper that is loaded enables your mobile device to know what paper size it is printing.

6 Manage toner, media, and parts

- [Check the toner level](#)
- [Reload toner](#)
- [Replace the imaging drum](#)
- [Order supplies, media, and parts](#)

Check the toner level

When the toner in the printer runs low, you will need one or two HP Toner Reload Kits to add toner. You can purchase original HP Toner Reload Kits from www.hp.com/go/suresupply or your local HP reseller.

Check the toner level indicator on the front of the printer to determine when to add toner.



NOTE: Always check the Reload Status light  next to the reload port to determine whether or not toner can be added.

Toner can be added when the Reload Status light  next to the reload port glows white. Toner cannot be added when the light is off. If the light is off, there may still be too much toner to accept a full reload, or the imaging drum may need to be replaced soon.



Full: Toner level is high and more toner cannot be added at this time.



Fill: Toner level is low. "+1" means one Toner Reload Kit can be added.



Low: Toner level is low. "+2" means two Toner Reload Kits can be added.



Very Low: Toner is depleted. Printer will not print until toner is added.

Reload toner

Use the Reload Status light  (near the reload port) and the toner level indicator (on the front of the printer) to determine when to add toner.

To reload toner

1. Make sure the printer is **powered on** and the Reload Status light  is glowing steady white. Toner cannot be added when the light is off.
2. Shake the Toner Reload Kit for at least 10 seconds. You should hear the ball inside mixing the toner.

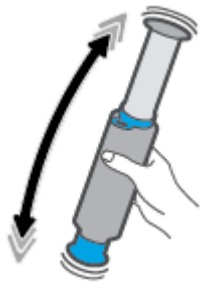

3. Remove the ring and the cap.

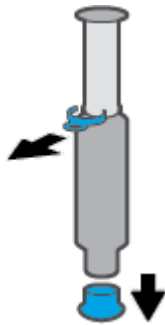

4. Uncover the reload port.



5. Insert the Toner Reload Kit into the reload port and rotate it clockwise 180° until it stops.

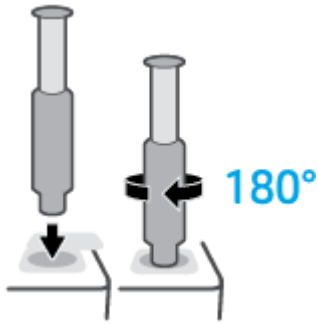

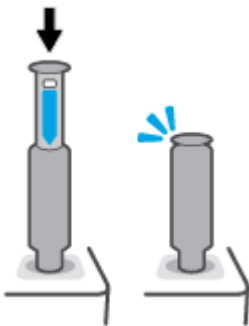

6. Push the plunger down completely until you hear a click.

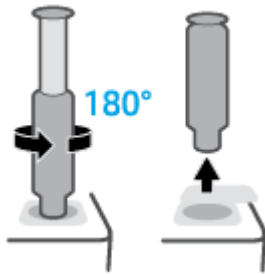

 **IMPORTANT:** If the white label at the top of the plunger is still visible, the plunger is incomplete. Pull up the plunger and push it down again until the white label disappears.

7. Rotate the Toner Reload Kit counterclockwise 180° to disengage it from the port. Remove the kit from the port and recycle it.



 **NOTE:** If you are unable to rotate the kit, the plunger is not all the way down. Repeat steps 6 and 7. If you still cannot undock the kit, press the **Cancel** button  on the control panel, remove and thoroughly shake the kit, and then try again.

8. Cover the reload port.

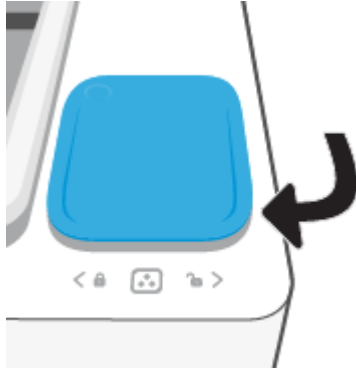

Replace the imaging drum

To replace the imaging drum

1. Lift the top cover.

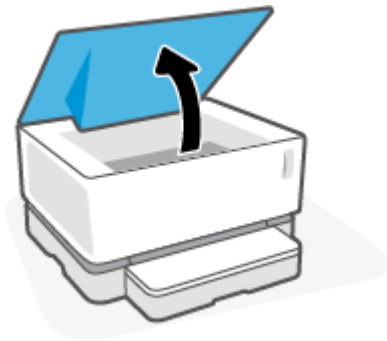

2. Remove and recycle the used imaging drum.

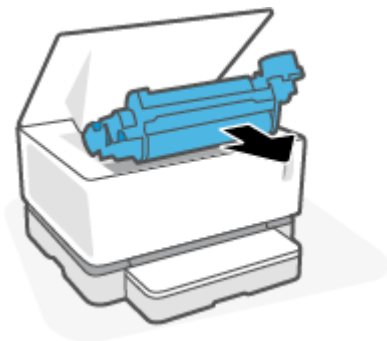

3. Remove the orange cover from the new imaging drum, while carefully pulling the two tabs out of the imaging drum as you remove the cover.



4. Shake the new imaging drum.

5. Insert the new imaging drum in the printer.

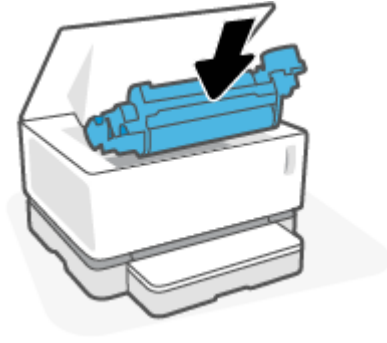

6. Lower the top cover.



Order supplies, media, and parts

Table 6-1 Ordering information

Order supplies and paper	www.hp.com/go/suresupply
Order genuine HP parts or accessories	https://parts.hp.com
Order through service or support providers	Contact an HP-authorized service or support provider.
General information	www.hp.com/support
Order using the HP Embedded Web Server (EWS)	To access, in a supported Web browser on the computer, enter the printer IP address or host name in the address/URL field. The EWS contains a link to the HP SureSupply Web site, which provides options for purchasing Original HP supplies.

Table 6-2 Supplies

Item	Description
HP 103A/143A Black Original Neverstop Laser Toner Reload Kit	One toner reload kit
HP 103AD/143AD Dual Pack Black Original Neverstop Laser Toner Reload Kit	Package of two toner reload kits.
HP 104A/144A Black Original Laser Imaging Drum	Replacement imaging drum

7 Solve problems

- [HP support](#)
- [Interpret control-panel light patterns](#)
- [Restore the factory-set defaults](#)
- [Printer does not pick up paper or misfeeds](#)
- [Clear paper jams](#)
- [Improve print quality](#)
- [Resolving print quality problems](#)
- [Solve wireless network problems](#)
- [Solve Ethernet connection problems](#)

HP support

For the latest product updates and support information, visit the product support website at www.support.hp.com. HP online support provides a variety of options for help with your printer:



Get software and drivers: Download software, drivers, and firmware you need for the printer.



Ask the community: Join the community forums to find solutions, ask questions, and share tips.



HP Diagnostic Tools: Use HP online tools to detect your printer and find recommended solutions.

Contact HP

If you need help from an HP technical support representative to solve a problem, visit the [Contact Support website](#). The following contact options are available at no cost for in-warranty customers (HP agent-assisted support for out-of-warranty customers may require a fee):



Chat with an HP support agent or the HP Virtual Agent online.



Call an HP support agent.

When contacting HP support, be prepared to provide the following information:

- Product name (located on the printer)
- Product number (located on the label on the back of the printer)
- Serial number (located on the back or bottom of the printer)

Register printer

By taking just a few minutes to register, you can enjoy quicker service, more efficient support, and product support alerts. If you did not register your printer while installing the software, you can register now at <http://www.register.hp.com>.

Additional warranty options

Extended service plans are available for the printer at additional costs. Go to www.support.hp.com, select your country/region and language, then explore the extended warranty options available for your printer.

Additional information

Go to www.hp.com/support . Select your country/region. Enter the product name, and then select **Search**

Instructions are available for performing various tasks, such as the following:

- Troubleshooting your printer
- Printing from various applications, and from various devices
- Obtaining support

You will find documents, videos, and many other resources to help you get the most from your printer.

Interpret control-panel light patterns

Table 7-1 Status-light legend



	Example symbol for "light blinking"
	Example symbol for "light on"

Table 7-2 Control-panel light patterns

















Light status	State of the printer	Action
Resume light and Cancel light are on. 	The printer is in manual-feed mode for printing envelopes or labels.	Load an envelope or sheet of labels into the input tray, and then press the Resume button  to continue. Or press the Cancel button  to cancel the current job.
	The printer is processing a manual duplex job.	Load the pages into the input tray to print the second sides, and then press the Resume button  to continue. Or press the Cancel button  to cancel the current job.
	The printer received a request for Google Cloud Print registration.	Press the Resume button  to continue or press the Cancel button  to stop.
Attention light is blinking. Paper light, Resume light, and Cancel light are on. 	The paper type or size loaded in the input tray is different than the paper type or size specified in the print job settings.	Load the paper type and size that matches the print job settings into the input tray, or press the Resume button  to continue with the currently loaded paper. Alternately, you can press the Cancel button  to cancel the current job.
Wi-Fi Direct light is blinking. Cancel light is on. 	The printer has received a request to connect to this printer using Wi-Fi Direct.	Press the Wi-Fi Direct button  to connect or press the Cancel button  to stop.
Attention light and Paper light are blinking. 	The input tray is empty.	Load the input tray.
Attention light is blinking. 	A door is open.	Verify that the top cover is fully closed.
Attention light is blinking. Paper light, Resume light, and Cancel light are on. 	Paper is jammed in the input tray.	Clear the jam. Press the Resume button  to continue.

Table 7-2 Control-panel light patterns (continued)



















Light status	State of the printer	Action
Attention light is blinking. Paper light and Cancel light are on. 	Paper is jammed in the imaging drum area.	Clear the jam.
Toner Warning light (on the toner level indicator) is blinking (amber). Reload Status light (next to the reload port) is on (white). 	The toner level is too low for printing.	Add toner using a Toner Reload Kit.
Attention light and Imaging Drum light are blinking. 	The imaging drum has reached the end of its service life and must be replaced.	Replace the imaging drum.
Reload Status light (next to the reload port) is amber and blinking rapidly. 	There is a problem with the Toner Reload Kit.	Use a different Toner Reload Kit. You must wait until the Reload Status light  turns white before attempting to reload toner.
Attention light is blinking and Imaging Drum Light is on. 	The imaging drum is missing or incorrectly installed.	Install or reinstall the imaging drum.
	There is a problem with the imaging drum.	Use a different imaging drum.
	There is a problem reading the toner level.	Remove and shake the imaging drum, and then reinstall it.
	Imaging drum seal in place.	Remove the seal on the imaging drum.
Attention light is on. 	There is a problem detected by the imaging drum sensor.	
	There is an issue with the flatbed scanner.	Turn off the device and then turn it on. If the problem persists, contact HP support.
	Paper wrap jam.	Contact HP support. A service call is required to clear the jam without damaging the print engine.
	There is an issue with the print engine.	Turn off the device and then turn it on. If the problem persists, contact HP support.
	There is a problem with the wireless hardware.	Turn off the device and then turn it on. If the problem persists, contact HP support.
Reload Status light is amber and blinking rapidly. 	The toner level is full and the printer cannot accept additional toner at this time.	Remove the Toner Reload Kit and wait until the Reload Status light  turns white before attempting to reload toner.
	The printer cannot accept additional toner at this time either because it is busy, or the imaging drum is too close to the end of its useful life.	Remove the Toner Reload Kit and wait until the Reload Status light  turns white before attempting to reload toner.

Table 7-2 Control-panel light patterns (continued)

Light status	State of the printer	Action
	The previous Toner Reload Kit was not completely emptied into the printer.	Remove the current Toner Reload Kit, reinstall the previous Toner Reload Kit, and make sure that the toner is dispensed completely into the printer.
	There is a problem with the Toner Reload Kit in the reload port.	Use a different Toner Reload Kit to add toner. You must wait until the Reload Status light  turns white before attempting to reload toner.
Toner Warning light (on the toner level indicator) and Reload Status light (next to the reload port) are blinking amber. 	There is a problem with the Toner Reload Kit docking motor.	Clear any debris from the reload port.
Wireless light is on (amber) and the Cancel light is blinking. 	An error occurred when attempting a wireless WPS connection.	Press the Cancel button  to continue.
Attention light is blinking and Resume light is on. 	The wireless hardware is not detected.	Press the Resume button  to continue without the wireless hardware.
	Incorrect firmware has been loaded.	Press the Resume button  to continue. Load the correct firmware.

Restore the factory-set defaults

Restoring the factory-set defaults returns all of the printer and network settings to the factory defaults. It will not reset the page count. To restore the printer to the factory-default settings, follow these steps.

 **CAUTION:** Restoring the factory-set defaults returns all of the settings to the factory defaults.

1. Open the HP Embedded Web Server (EWS). For more information, see the Accessing and Using the Embedded Web Server (EWS) section of this User Guide.
2. On the **System** tab, click **Service**.
3. In the **Restore Defaults** area, click the **Restore defaults** button.

The printer automatically restarts.

Printer does not pick up paper or misfeeds

Introduction

The following solutions can help solve problems if the printer is not picking up paper from the input tray or is picking up multiple sheets of paper at one time. Either of these situations can result in paper jams.

- [The product does not pick up paper](#)
- [The product picks up multiple sheets of paper](#)

The product does not pick up paper

If the product does not pick up paper from the input tray, try these solutions.

1. Open the product and remove any jammed sheets of paper.
2. Load the correct size of paper for your job.
3. Make sure you select the correct paper size and type when setting up the print job.
4. Make sure the paper guides in the input tray are adjusted correctly for the size of paper.
5. The rollers above the input tray might be contaminated. Clean the rollers with a lint-free cloth dampened with warm water.

The product picks up multiple sheets of paper

If the product picks up multiple sheets of paper from the input tray, try these solutions.

1. Remove the stack of paper from the input tray and flex it, rotate it 180 degrees, and flip it over. Return the stack of paper to the input tray.
2. Use only paper that meets HP specifications for this product.
3. Use paper that is not wrinkled, folded, or damaged. If necessary, use paper from a different package.
4. Make sure the input tray is not overfilled. If it is, remove the entire stack of paper from the tray, straighten the stack, and then return some of the paper to the input tray.
5. Make sure the paper guides in the tray are adjusted correctly for the size of paper.
6. Make sure the printing environment is within recommended specifications.

Clear paper jams

Introduction

The following information includes instructions for clearing paper jams from the printer.

- [Jam locations](#)
- [Frequent or recurring paper jams](#)
- [Clear jams from the input tray](#)
- [Clear jams from inside the product](#)
- [Clear jams from the output areas](#)

Jam locations

Jams can occur at the following locations in the product.

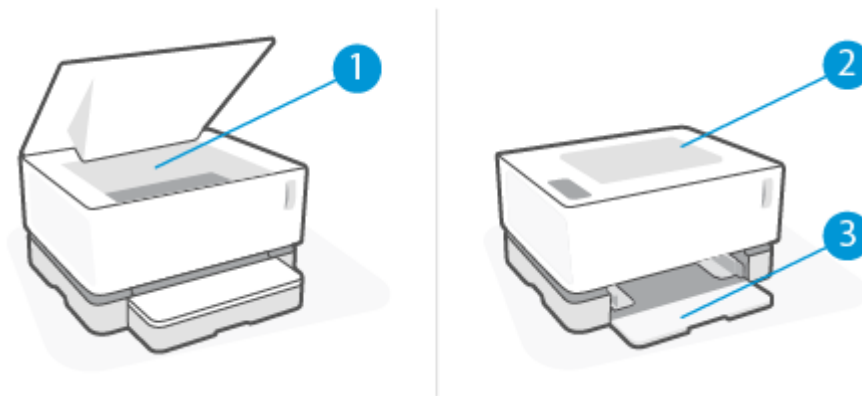



1	Internal areas
2	Output bin
3	Input tray

 **NOTE:** Jams can occur in more than one location.

Frequent or recurring paper jams



Follow these steps to solve problems with frequent paper jams. If the first step does not resolve the problem continue with the next step until you have resolved the problem.

1. If paper has jammed in the printer, clear the jam and then print a configuration page to test the printer.
2. Check that the input tray is configured for the correct paper size and type. Adjust paper settings if necessary.
 - a. Print a configuration page to determine the IP address or host name.
 - i. Press and hold the Resume  button for three seconds.
 - ii. Release the Resume  button.
 - b. Open a web browser, and in the address line, type the IP address or host name exactly as it displays on the printer configuration page. Press the Enter key on the computer keyboard. The EWS opens.

 **NOTE:** If the web browser displays a message indicating that accessing the website might not be safe, select the option to continue to the website. Accessing this website will not harm the computer.

 - c. Click the **System** tab, and then click the **Paper Setup** page.
 - d. From the **Tray 1 Type** drop-down list, select the type of paper that is in the input tray.
 - e. From the **Tray 1 Size** drop-down list, select the size of paper that is in the input tray.

 **NOTE:** You can also use the **Default Paper Type** and **Default Paper Size** options to change the default settings to match the paper you use most frequently.

3. Turn the printer off, wait 30 seconds, and then turn it on again.
4. Print a configuration page to test the printer.
 - a. Press and hold the Resume  button for three seconds.
 - b. Release the Resume  button.

If none of these steps resolves the problem, the printer might need service. Contact HP customer support.

Clear jams from the input tray

⚠ CAUTION: Do not use sharp objects, such as tweezers or needle-nose pliers, to remove jams. Damage caused by sharp objects will not be covered by the warranty.

When removing jammed media, pull the jammed media straight away from the product. Pulling jammed media out of the product at an angle can damage the product.

📝 NOTE: Depending on where the jam is located, some of the following steps might not be necessary.

1. Lift the top cover, and then remove the imaging drum.

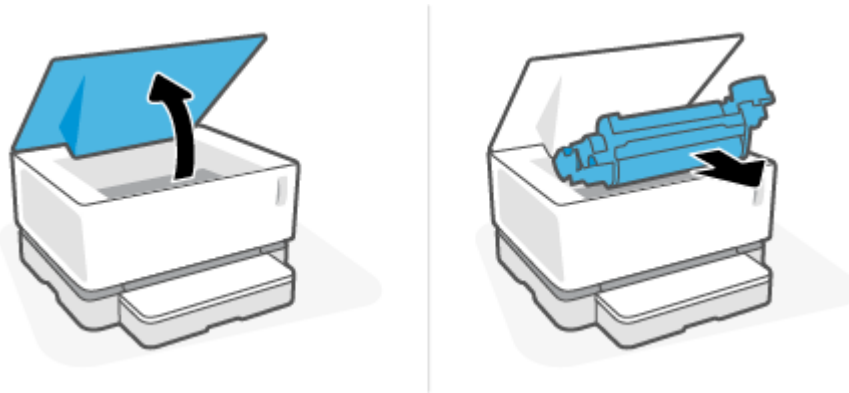

⚠ CAUTION: To prevent damage, do not expose the imaging drum to light. Cover it with a piece of paper.

2. Remove the media stack from the input tray.

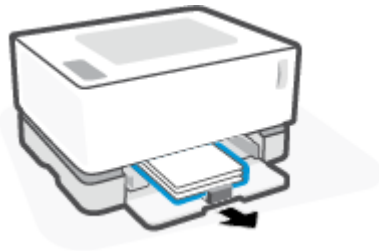

3. With both hands, grasp the side of the jammed media that is most visible (this includes the middle), and carefully pull it free from the product.

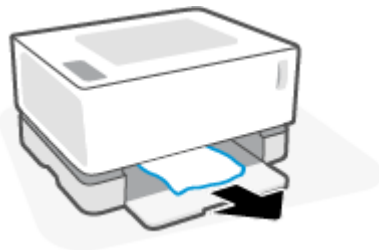

4. Reinstall the imaging drum, and then lower the top cover.

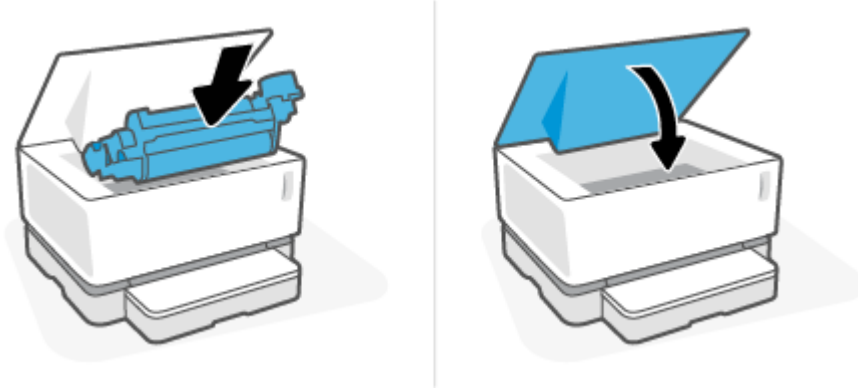

Clear jams from inside the product

⚠ CAUTION: Do not use sharp objects, such as tweezers or needle-nose pliers, to remove jams. Damage caused by sharp objects will not be covered by the warranty.

When removing jammed media, pull the jammed media straight away from the product. Pulling jammed media out of the product at an angle can damage the product.

1. Lift the top cover, and then remove the imaging drum.

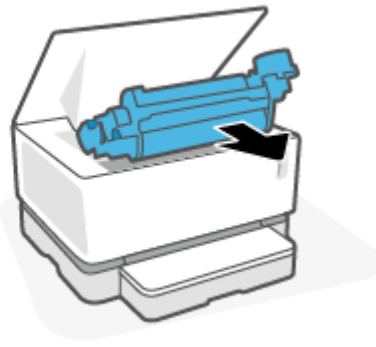
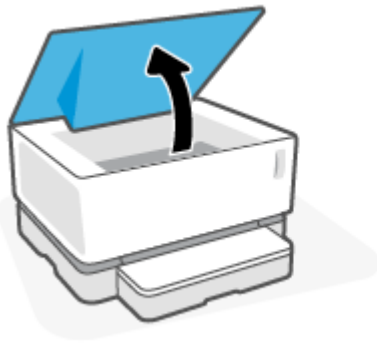

⚠ CAUTION: To prevent damage, do not expose the imaging drum to light. Cover it with a piece of paper.

2. If you can see the jammed paper, carefully grasp the jammed paper, and slowly pull it out of the product.



3. Reinstall the imaging drum, and then lower the top cover.

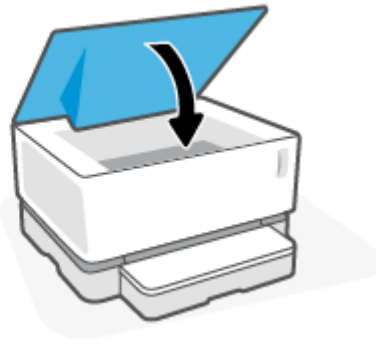
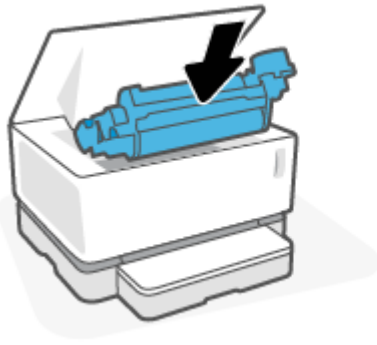

Clear jams from the output areas

⚠ CAUTION: Do not use sharp objects, such as tweezers or needle-nose pliers, to remove jams. Damage caused by sharp objects will not be covered by the warranty.

- ▲ Carefully grasp the jammed paper in the output bin area, and slowly pull it out of the product.

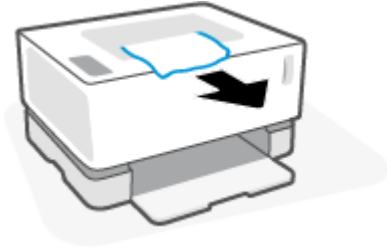

Improve print quality

- [Introduction](#)
- [Reprint the document](#)
- [Check the toner level](#)
- [Update the printer firmware](#)
- [Print from a different software program](#)
- [Check the paper type and print quality settings for the print job](#)
- [Visually inspect the imaging drum](#)
- [Check paper and the printing environment](#)
- [Adjust Print Density](#)

Introduction

Print-quality problems, such as smears, streaks, missing toner, and so on, can often be resolved using the same steps, no matter the specific symptoms. Try the following steps in the order presented as a starting point for resolving print quality issues.

For information about resolving specific image defects, see the Resolving print quality problems section of this User Guide.

Reprint the document

Reprint the document. Print quality defects can be intermittent in nature or can go away completely with continued printing.

Check the toner level

If the toner level is low, reload toner. For more information, see the Check the toner level section of this User Guide.

Update the printer firmware

Try upgrading the printer firmware. For more information, see the Update the firmware section of this User Guide.

Print from a different software program

Try printing from a different software program. If the page prints correctly, the problem is with the software program from which you were printing.

Check the paper type and print quality settings for the print job

Check the paper type and print quality settings when printing from a software program and the printed pages have smears, fuzzy or dark print, curled paper, scattered dots of toner, loose toner, or small areas of missing toner. Make sure the paper type setting matches the type of paper loaded in the printer.

Check the paper type loaded in the printer

1. Remove the input tray cover.

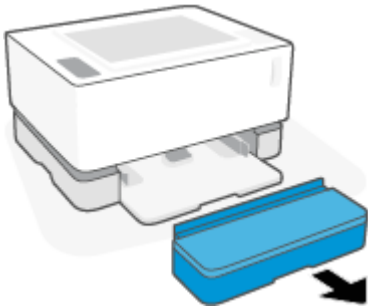

2. Verify that the input tray is loaded with the correct type of paper.
3. Reinstall the input tray cover.

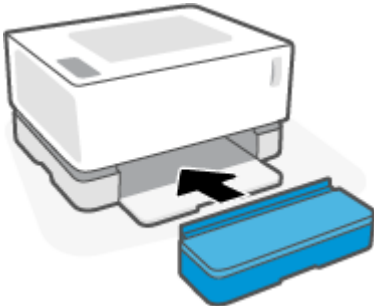

Check the paper type and print quality settings (Windows)

1. From the software program, select the **Print** option.
2. Select the printer, and then click the **Properties** or **Preferences** button.
3. Click the **Paper/Quality** tab.
4. Expand the **Paper Type** option to see the paper types that are available.
5. Select the option for the type of paper you are using.
6. From the **Print Quality** drop-down list, select an option. Select lower quality to print faster and save ink, or higher quality to obtain sharper prints.
7. Click the **OK** button to close the **Document Properties** dialog box. In the **Print** dialog box, click the **OK** button to print the job.

Check the paper type and print quality settings (OS X)

1. Click the **File** menu, and then click the **Print** option.
2. In the **Printer** menu, select the printer.
3. Choose paper type from the **Media & Quality** option..

4. Select a print quality option. Select lower quality to print faster and save ink, or higher quality to obtain sharper prints.
5. Click the **Print** button.

Visually inspect the imaging drum

Follow these steps to inspect the imaging drum.

1. Remove the imaging drum from the printer, and verify that the sealing tape has been removed.
2. Check the memory chip for damage (for example, broken edges or a scratched surface). The memory chip is located on the part of the imaging drum that is closest to the reload port when the drum is installed.
3. Examine the surface of the green roller on the imaging drum.

 **CAUTION:** Do not touch the green roller on the imaging drum. Fingerprints on this surface can cause print-quality problems.

4. If you see any scratches, fingerprints, or other damage on the imaging drum, replace the imaging drum.
5. Reinstall the imaging drum, and print a few pages to see if the problem has resolved.

Check paper and the printing environment

Step one: Use paper that meets HP specifications

Some print-quality problems arise from using paper that does not meet HP specifications.

- Make sure that the paper type, size, and weight are supported by the printer.
- Use paper that is of good quality and free of cuts, nicks, tears, spots, loose particles, dust, wrinkles, voids, staples, and curled or bent edges.
- Use paper that has not been previously printed on.
- Use paper that does not contain metallic material, such as glitter.
- Use paper that is designed for use in laser printers. Do not use paper that is designed only for use in Inkjet printers.
- Use paper that is not too rough. Using smoother paper generally results in better print quality.

If print quality issues persist on good quality paper that is within the HP specifications, and you have also tried the other recommended solutions, try using paper from a different package.

Step two: Check the environment

The environment can directly affect print quality and is a common cause for print-quality or paper-feeding issues. Try the following solutions:

- Move the printer away from drafty locations, such as open windows or doors, or air-conditioning vents.
- Make sure the printer is not exposed to temperatures or humidity outside of printer specifications.
- Do not place the printer in a confined space, such as a cabinet.

- Place the printer on a sturdy, level surface.
- Remove anything that is blocking the vents on the printer. The printer requires good air flow on all sides, including the top.
- Protect the printer from airborne debris, dust, steam, grease, or other elements that can leave residue inside the printer.

Adjust Print Density

Complete the following steps to adjust the print density.

1. Open the HP Embedded Web Server (EWS).
 - Use the HP Smart app to access the EWS, if available.
 - Use the HP Printer Assistant for Windows 7 systems.
 - Press and hold the Resume button  to print a configuration page, then navigate to the IP address shown on the printer configuration page.



NOTE: If you receive a message indicating that accessing the website might not be safe, select the option to continue to the website. Accessing this website will not harm the computer.

2. Click the **System** tab, and then select **System Setup** from the left navigation pane.
3. Select the correct density settings.
4. Click **Apply** to save the changes.

Resolving print quality problems

The following information provides troubleshooting steps for solving specific image defect issues, including the following defects:

- Light print
- Gray background or dark print
- Blank pages
- Black pages
- Dark or light bands
- Dark or light streaks
- Missing toner
- Skewed images
- Curled paper

Find the example in this section that matches the print quality issue you are experiencing and follow the provided solution steps.

The following examples depict letter-size paper that has passed through the printer short-edge first.



NOTE: The term “fusing” refers to the part of the printing process where toner is affixed to paper.

Table 7-3 Light print

Description	Sample	Possible solutions
<p>Light print:</p> <p>The printed content on the entire page is light or faded.</p>		<ol style="list-style-type: none">1. Reprint the document.2. Remove the imaging drum, and then shake it to redistribute the toner.3. Make sure that the imaging drum is installed correctly.4. Print a configuration report and check for life and usage of the imaging drum.5. If the toner is low, reload toner.6. If the problem persists, go to support.hp.com.

Table 7-4 Gray background or dark print

Description	Sample	Possible solutions
<p>Gray background or dark print:</p> <p>The image or text is darker than expected.</p>		<ol style="list-style-type: none"> 1. Make sure that the paper in the input tray has not already been run through the printer. 2. Use a different paper type. 3. Reprint the document. 4. From the printer EWS, go to the Adjust Toner Density menu, and then adjust the toner density to a lower level. 5. Make sure that the printer is in within the supported operating temperature and humidity range. 6. If the toner is low, reload toner. 7. If the problem persists, go to support.hp.com.

Table 7-5 Blank page — No print

Description	Sample	Possible solutions
<p>Blank page — No print:</p> <p>The page is completely blank and contains no printed content.</p>		<ol style="list-style-type: none"> 1. Make sure that the imaging drum is installed correctly. 2. Check the paper type in the input tray and adjust the printer settings to match. If necessary, select a lighter paper type. 3. If the problem persists, go to support.hp.com.

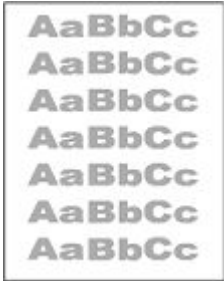
Table 7-6 Black page

Description	Sample	Possible solutions
<p>Black page:</p> <p>The entire printed page is black.</p>		<ol style="list-style-type: none"> 1. Visually inspect the imaging drum to check for damage. 2. Make sure that the imaging drum is installed correctly. 3. Replace the imaging drum. 4. If the problem persists, go to support.hp.com.

Table 7-7 Banding defects

Description	Sample	Possible solutions
<p>Repetitive wide-pitch banding and impulse bands:</p> <p>Dark or light lines which repeat down the length of the page. They might be sharp or soft in nature. The defect displays only in areas of fill, not in text or sections with no printed content.</p>		<ol style="list-style-type: none"> 1. Reprint the document. 2. If the toner is low, reload toner. 3. Use a different paper type. 4. If the problem persists, go to support.hp.com.

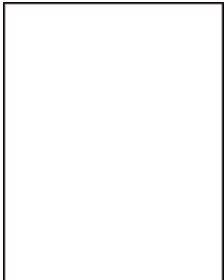
Table 7-8 Streak defects

Description	Sample	Possible solutions
<p>Light vertical streaks:</p> <p>Light streaks that usually span the length of the page. The defect displays only in areas of fill, not in text or sections with no printed content.</p>		<ol style="list-style-type: none"> 1. Reprint the document. 2. Remove the imaging drum, and then shake it to redistribute the toner. 3. If the problem persists, go to support.hp.com. <p>NOTE: Both light and dark vertical streaks can occur when the printing environment is outside the specified range for temperature or humidity. Refer to your printer's environmental specifications for allowable temperature and humidity levels.</p>
<p>Dark vertical streaks:</p> <p>Dark lines which occur down the length of the page. The defect might occur anywhere on the page, in areas of fill or in sections with no printed content.</p>		<ol style="list-style-type: none"> 1. Reprint the document. 2. Remove the imaging drum, and then shake it to redistribute the toner. 3. If the toner level is low, reload toner. 4. If the problem persists, go to support.hp.com.

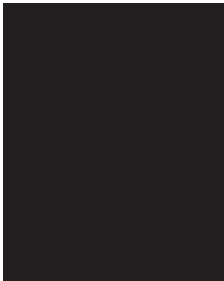
Table 7-9 Fixing/fuser defects

Description	Fixing/fuser	Possible solutions
<p>Hot fuser offset (shadow):</p> <p>Slight shadows, or offsets, of the image repeated down the page. The repeated image might fade with each recurrence.</p>		<ol style="list-style-type: none"> 1. Reprint the document. 2. Check the paper type in the input tray and adjust the printer settings to match. If necessary, select a lighter paper type. 3. If the problem persists, go to support.hp.com.
<p>Poor fusing:</p> <p>Toner rubs off along either edge of page. This defect is more common at the edges of high-coverage jobs and on light media types but can occur anywhere on the page.</p>		<ol style="list-style-type: none"> 1. Reprint the document. 2. Check the paper type in the input tray and adjust the printer settings to match. If necessary, select a heavier paper type. 3. If the problem persists, go to support.hp.com.

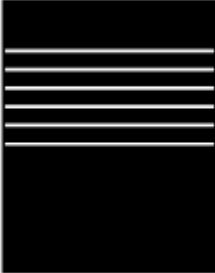
Table 7-10 Image placement defects

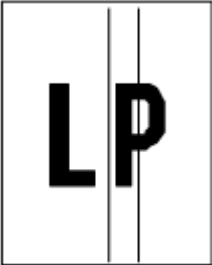

Description	Sample	Possible solutions
<p>Margins and skew:</p> <p>The image is not centered, or is skewed on the page. The defect occurs when the paper is not positioned properly as it is pulled from the input tray and moves through the paper path.</p>		<ol style="list-style-type: none"> 1. Reprint the document. 2. Remove the paper and then reload the input tray. Make sure that all the paper edges are even on all sides. 3. Make sure that the top of the paper stack is below the input tray full indicator. Do not overfill the input tray. 4. Make sure that the paper guides are adjusted to the correct size for the paper. Do not adjust the paper guides tightly against the paper stack. 5. If the problem persists, go to support.hp.com.

Table 7-11 Output defects

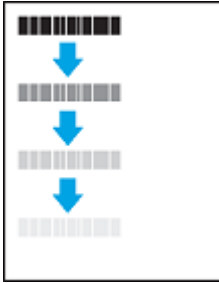
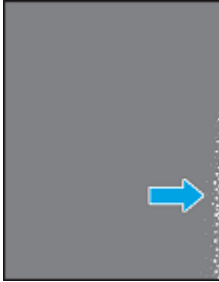
Description	Sample	Possible solutions
<p>Output curl:</p> <p>Printed paper has curled edges. The curled edge can be along the short or long side of the paper. Two types of curl are possible:</p> <ul style="list-style-type: none">• Positive curl: The paper curls toward the printed side. The defect occurs in dry environments or when printing high coverage pages.• Negative curl: The paper curls away from the printed side. The defect occurs in high-humidity environments or when printing low coverage pages.		<ol style="list-style-type: none">1. Reprint the document.2. Positive curl: From the printer EWS, select a heavier paper type. The heavier paper type creates a higher temperature for printing. Negative curl: From the printer EWS, select a lighter paper type. The lighter paper type creates a lower temperature for printing. Try storing the paper in a dry environment prior or use freshly opened paper.3. From the printer EWS, turn on the Less Paper Curl option. (Click the System tab, select Service, and then select Less Paper Curl.)4. If the problem persists, go to support.hp.com.
<p>Output stacking:</p> <p>The paper does not stack well in the output tray. The stack might be uneven, skewed, or the pages might be pushed out of the tray and onto the floor. Any of the following conditions can cause this defect:</p> <ul style="list-style-type: none">• Extreme paper curl• The paper in the tray is wrinkled or deformed• The paper is a non-standard paper type, such as envelopes• The output tray is too full		<ol style="list-style-type: none">1. Reprint the document.2. Extend the output bin extension.3. If the defect is caused by extreme paper curl, complete the troubleshooting steps for Output curl.4. Use a different paper type.5. Use freshly opened paper.6. Remove the paper from the output tray before the tray gets too full.7. If the problem persists, go to support.hp.com.

Solve wireless network problems

- [Introduction](#)
- [Wireless connectivity checklist](#)
- [Perform a wireless network diagnostic test](#)
- [The printer does not print after the wireless configuration completes](#)
- [The printer does not print, and the computer has a third-party firewall installed](#)
- [The wireless connection does not work after moving the wireless router or printer](#)
- [Cannot connect more devices to the wireless printer \(Wi-Fi Direct\)](#)
- [The wireless printer loses communication when connected to a VPN](#)
- [The network does not appear in the wireless networks list](#)
- [The wireless network is not functioning](#)
- [Reduce interference on a wireless network](#)

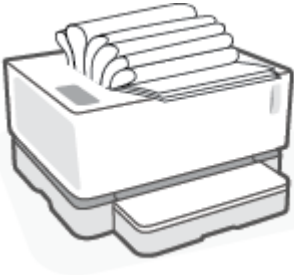
Introduction

Use the troubleshooting information to help resolve issues.

Wireless connectivity checklist

- Verify that the printer and the wireless router are turned on and have power. Also make sure that the wireless radio in the printer is turned on. The Wireless light (📶) should be blue to indicate that the printer is connected. (If the light is blinking, the printer is in setup mode or attempting to connect.)
- Verify that the network name (service set identifier, or SSID) is correct. Print a configuration page to determine the SSID.
 - a. Press and hold the Resume (📄) button for three seconds.
 - b. Release the Resume (📄) button.

If you are not sure the SSID is correct, run the wireless setup again.

- With secured networks, verify that the security information is correct. If the security information is incorrect, run the wireless setup again.
- Verify that the encryption method (AES or TKIP) is the same for the printer as it is for the wireless access point (on networks using WPA security).
- Check the Wi-Fi Signal Strength indicator (📶 or 📶) on the control panel. If only one or two bars or dots are showing, the wireless signal is weak. Verify that the printer is within the range of the wireless network. For most networks, the printer must be within 30 m (100 ft) of the wireless access point (wireless router).

- Verify that obstacles do not block the wireless signal. Remove any large metal objects between the access point and the printer. Make sure poles, walls, or support columns containing metal or concrete do not separate the printer and wireless access point.
- Verify that the printer is located away from electronic devices that might interfere with the wireless signal. Many devices can interfere with the wireless signal including motors, cordless phones, security system cameras, other wireless networks, and some Bluetooth devices.
- Verify that your router is set for 2.4 GHz operation. The printer only supports connections using this frequency.
- Verify that the print driver is installed on the computer.
- Verify that you have selected the correct printer port.
- Verify that the computer and printer connect to the same wireless network.
- For OS X, verify that the wireless router supports Bonjour.

Perform a wireless network diagnostic test

A wireless network diagnostic test can be performed using the printer control panel or the Embedded Web Server (EWS). The wireless network diagnostic test provides information about the wireless network settings.

Method one: Perform a wireless network diagnostic test using the printer control panel

- ▲ From the printer control panel, press and hold the Wireless button  for 10 seconds.

Method two: Perform wireless network diagnostic test using the EWS

1. Open the HP Embedded Web Server (EWS).
 - Use the HP Smart app to access the EWS, if available.
 - Use the HP Printer Assistant for Windows 7 systems.
 - Press and hold the Resume button  to print a configuration page, then navigate to the IP address shown on the printer configuration page.

 **NOTE:** If you receive a message indicating that accessing the website might not be safe, select the option to continue to the website. Accessing this website will not harm the computer.

2. Select the **Networking** tab.
3. On the **Wireless Configuration** page, verify that the On option is selected.
4. Click the **Print Test Report** button to print a test page that shows test results.

The printer does not print after the wireless configuration completes



1. Make sure that the printer is turned on and in the ready state.
2. Make sure that the wireless network is working correctly.
3. Make sure that your computer or mobile device is working correctly. If necessary, restart your computer or mobile device.

4. Make sure that the correct printer driver is installed (Windows).
5. Verify that you can open the printer HP Embedded Web Server from a computer or mobile device on the network.
6. Print a configuration page to verify the printer successfully connected to the wireless network and is assigned an IP address.

The printer does not print, and the computer has a third-party firewall installed



1. Update the firewall with the most recent update available from the manufacturer.
2. If programs request firewall access when you install the printer or try to print, make sure you allow the programs to run.
3. Temporarily turn off the firewall, and then install the wireless printer on the computer. Enable the firewall when you have completed the wireless installation.

The wireless connection does not work after moving the wireless router or printer

1. Check the Wi-Fi Signal Strength indicator ( or ) on the printer control panel. If only one or two bars or dots are showing, the wireless signal is weak. Verify that the printer is within the range of the wireless network. For most networks, the printer must be within 30 m (100 ft) of the wireless access point (wireless router). Also, make sure there are no large obstacles between the printer and the network router that could be blocking the signal and remove any electronic devices near the printer that could be interfering with the wireless signal.
2. Print a configuration page.
3. Compare the network name (SSID) on the configuration report to the SSID of the network the computer is on.

If the SSIDs are not the same, the devices are not connecting to the same network. Reconfigure the wireless setup for the printer.

Cannot connect more devices to the wireless printer (Wi-Fi Direct)

1. Make sure that each device is within the wireless range and that no obstacles block the signal. (For Wi-Fi Direct printing, the device must be within wireless range of the printer.)
2. Make sure that the printer is turned on and in the ready state.
3. Make sure that Wi-Fi Direct light  on the printer control panel is on. If it is off, press the Wi-Fi Direct button .
4. Make sure that you have turned on Wi-Fi Direct or Wi-Fi on your device. If your device supports neither, you cannot set up a Wi-Fi Direct connection with that device.
5. Make sure there are not more than 5 concurrent Wi-Fi Direct users.



The wireless printer loses communication when connected to a VPN

- Typically, you cannot connect to a VPN and other networks at the same time.

The network does not appear in the wireless networks list

- Make sure the wireless router is turned on and has power.
- The network might be hidden.
- Make sure that the printer is within wireless range of the wireless router, and that there are no obstacles blocking the signal.
- The printer operates on the 2.4 GHz wireless band. Any 5 GHz networks will not show up in the list.
- Refresh the wireless networks list.
- Try restarting the printer.

The wireless network is not functioning

1. To verify if the network has lost communication, try connecting other devices to the network.
2. Test network communication by pinging the network.
 - a. Open a command-line prompt on your computer.
 - For Windows, click **Start**, click **Run**, type `cmd`, and then press **Enter**.
 - For OS X, go to **Applications**, then **Utilities**, and open **Terminal**.
 - b. Type `ping` followed by the router IP address.
 - c. If the window displays round-trip times, the network is working.
3. Make sure that the router or printer connects to the same network that the computer connects to.
 - a. Print a configuration page.
 - i. Press and hold the Resume  button for three seconds.
 - ii. Release the Resume  button.
 - b. Compare the network name (SSID) on the configuration report to the SSID of the network the computer is on.

If the SSIDs are not the same, the devices are not connecting to the same network. Reconfigure the wireless setup for the printer.
4. Perform a wireless network diagnostic test. For more information, see the Perform a wireless network diagnostic test section of this User Guide.

Reduce interference on a wireless network

The following tips can reduce interference in a wireless network:

- Keep the wireless devices away from large metal objects, such as filing cabinets, and other electromagnetic devices, such as microwaves and cordless telephones. These objects can disrupt radio signals.
- Keep the wireless devices away from large masonry structures and other building structures. These objects can absorb radio waves and lower signal strength.
- Position the wireless router in a central location in line of sight with the wireless printers on the network.

Solve Ethernet connection problems

Check the following:

- The network is operational and the network hub, switch, or router is turned on.
- The Ethernet cable is properly connected between the printer and the router. The Ethernet cable is plugged into the Ethernet port on the printer and the light near the connector lights up when connected.
- Antivirus programs, including spyware protection programs, are not impacting your network connection to the printer. If you know that antivirus or firewall software is preventing your computer from connecting to the printer, use the [HP online firewall troubleshooter](#) to help solve the problem.
- Run the [HP Print and Scan Doctor](#) to troubleshoot the issue automatically. The utility will try to diagnose and fix the issue. The HP Print and Scan Doctor may not be available in all languages.

A Printer specifications

 **IMPORTANT:** The following specifications are correct at the time of publication, but they are subject to change. For current information, see www.hp.com/support.

- [Technical specifications](#)
- [Supported operating systems](#)
- [Printer dimensions](#)
- [Power consumption, electrical specifications, and acoustic emissions](#)
- [Operating-environment range](#)
- [Warning icons](#)
- [Laser Warning](#)

Technical specifications

See www.support.hp.com for current information.

Supported operating systems

The following information applies to the printer-specific Windows PCLmS and OS X print drivers.

Windows: The HP Software Installer installs the PCLmS, or PCLm-S driver depending on the Windows operating system, along with optional software when using the software installer. For more information, visit the product support website at www.hp.com/support.

OS X: Mac computers are supported with this printer. Download HP Easy Start either from 123.hp.com or from the product support website at www.hp.com/support, and then use HP Easy Start to install the HP print driver. HP Easy Start is not included in the HP Software Installer.

1. Go to 123.hp.com.
2. Follow the steps provided to download the printer software.

Linux: For information and print drivers for Linux, go to www.hp.com/go/linuxprinting.

Table A-1 Supported operating systems and print drivers

Windows 7, 32-bit and 64-bit	The HP PCLmS printer-specific print driver is installed for this operating system as part of the software installation.
------------------------------	---

Table A-1 Supported operating systems and print drivers (continued)

Windows 8, 32-bit and 64-bit	The HP PCLmS printer-specific print driver is installed for this operating system as part of the software installation.	Windows 8 RT support is provided through Microsoft IN OS Version 4, 32-bit driver.
Windows 8.1, 32-bit and 64-bit	The HP PCLm-S V4 printer-specific print driver is installed for this operating system as part of the software installation.	Windows 8.1 RT support is provided through Microsoft IN OS Version 4, 32-bit driver.
Windows 10, 32-bit and 64-bit	The HP PCLm-S V4 printer-specific print driver is installed for this operating system as part of the software installation.	
Windows Server 2008 R2, 64-bit	The HP PCLm.S printer-specific print driver is available for download from the printer-support website. Download the driver, and then use the Microsoft Add Printer tool to install it.	Microsoft retired mainstream support for Windows Server 2008 in January 2015. HP will continue to provide best effort support for the discontinued Server 2008 operating system.
Windows Server 2008 R2, SP1, 64-bit	The HP PCLmS printer-specific print driver is installed for this operating system as part of the software installation.	
Windows Server 2012	The HP PCLmS printer-specific print driver is installed for this operating system as part of the software installation.	
Windows Server 2012 R2	The HP PCLm-S printer-specific print driver is installed for this operating system as part of the software installation.	
Windows Server 2016, 64-bit	The HP PCLm-S printer-specific print driver is installed for this operating system as part of the software installation.	
OS X 10.11 El Capitan and later.	To install the print driver, download HP Easy Start from 123.hp.com . Follow the steps provided to install the printer software and print driver.	



NOTE: For a current list of supported operating systems, go to www.support.hp.com for HP's all-inclusive help for the printer.

Printer dimensions

Figure A-1 Dimensions for the printer

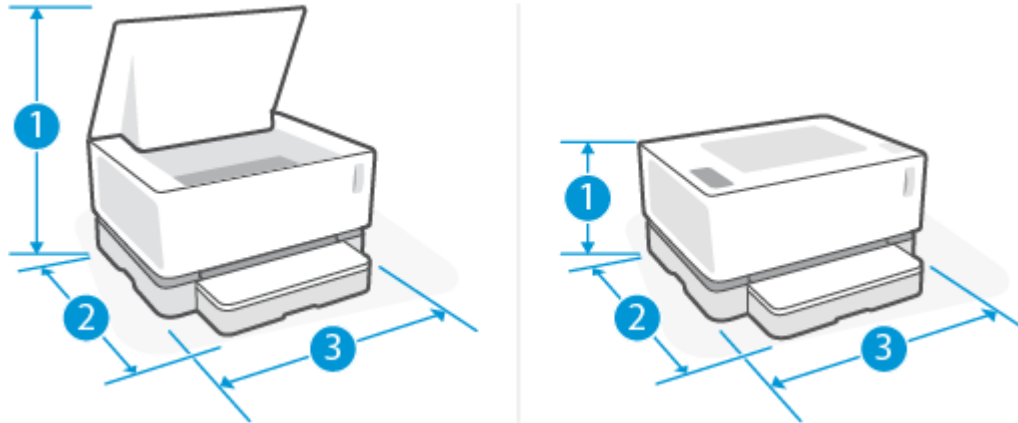

	Printer fully open	Printer fully closed
1. Height	445 mm (17.5 in)	211 mm (8.3 in)
2. Depth	465 mm (18.3 in)	371.5 mm (14.6 in)
3. Width	380.5 mm (14.9 in)	380.5 mm (14.9 in)
Weight (with imaging drum)	6.96 kg (15.34 lbs) (base models)	
	7.01 kg (15.45 lbs) (wireless models)	

Power consumption, electrical specifications, and acoustic emissions

See www.support.hp.com for current information.

CAUTION: Power requirements are based on the country/region where the printer is sold. Do not convert operating voltages. This will damage the printer and void the printer warranty.

Operating-environment range

Environment	Recommended	Allowed
Temperature	17.5° to 25°C (63.5° to 77°F)	15° to 32°C (59° to 89.6°F)
Relative humidity	20% to 70% relative humidity (RH), non-condensing	10% to 80% (RH), non-condensing
Altitude	Not applicable	0 to 5000 m (0 to 16,404 ft)

Warning icons

Warning icon definitions: The following warning icons may appear on HP products. Apply appropriate caution where applicable.

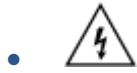

Caution: Electric shock



Caution: Hot surface



Caution: Keep body parts away from moving parts



Caution: Sharp edge in close proximity



Warning

Laser Warning



CAUTION - CLASS 3B INVISIBLE LASER RADIATION WHEN OPEN. AVOID EXPOSURE TO THE BEAM.

ATTENTION - RAYONNEMENT LASER INVISIBLE DE CLASSE 3B EN CAS D'OUVERTURE. ÉVITEZ L'EXPOSITION AU FAISCEAU.

VORSICHT - UNSICHTBARE LASERSTRAHLUNG KLASSE 3B, WENN ABDECKUNG GEÖFFNET. NICHT DEM STRAHL AUSSETZEN.

PRECAUCIÓN – RADIACIÓN LÁSER INVISIBLE DE CLASE 3B PRESENTE AL ABRIR. EVITE LA EXPOSICIÓN AL HAZ.

VARNING - OSYNLIG LASERSTRÅLNING KLASSE 3B VID ÖPPEN LUCKA UNDVIK EXPONERING FÖR LASERSTRÅLNINGEN.

VAROITUS - LUOKAN 3B NÄKYMÄTTÖMÄLLE LASER-SÄTEILYÄ AVATTUNA. VÄLTÄ ALTISTUMISTA SÄTEELLE.

注意 - 打开时，存在不可见的 3B 类激光辐射，请避免接触该激光束。

주의 - 열리면 등급 3B 비가시레이저방사선이 방출됩니다. 광선에 노출을 피하십시오.

注意 - ここを開くとクラス 3B 不可視レーザー放射が出ます。ビームに身をさらさないこと。

B Service and support

- [HP limited warranty statement](#)
- [HP's Premium Protection Warranty: Neverstop Toner Reload Kit and HP Laser Imaging Drum limited warranty statement](#)
- [HP policy on non-HP supplies](#)
- [HP anticounterfeit Web site](#)
- [Data stored on the HP Toner Reload Kit and the HP Laser Imaging Drum](#)
- [End User License Agreement](#)
- [Customer self-repair warranty service](#)
- [Customer support](#)

HP limited warranty statement

HP PRODUCT	DURATION OF LIMITED WARRANTY*
HP Neverstop Laser 1000a, 1000w, 1000n, 1001nw	One-year limited warranty



NOTE: *Warranty and support options vary by product, country, and local legal requirements. Go to support.hp.com to learn about HP award-winning service and support options in your region.

This HP Limited Warranty applies only to HP-branded products sold or leased a) from HP Inc., its subsidiaries, affiliates, authorized resellers, authorized distributors, or country distributors; and, b) with this HP Limited Warranty.

HP warrants to you, the end-user customer, that the HP hardware and accessories will be free from defects in materials and workmanship after the date of purchase, for the period specified above. If HP receives notice of such defects during the warranty period, HP will, at its option, either repair or replace products which prove to be defective, except as otherwise required by local law. Subject to local law, replacement products may be either new or equivalent in performance to new.

HP warrants to you that HP software will not fail to execute its programming instructions after the date of purchase, for the period specified above, due to defects in material and workmanship when properly installed and used. If HP receives notice of such defects during the warranty period, HP will replace software which does not execute its programming instructions due to such defects.

HP does not warrant that the operation of HP products will be uninterrupted or error free. If HP is unable, within a reasonable time, to repair or replace any product to a condition as warranted, you will be entitled to a refund of the purchase price upon prompt return of the product.

HP products may contain remanufactured parts equivalent to new in performance or may have been subject to incidental use.

Warranty does not apply to defects resulting from (a) improper or inadequate maintenance or calibration, (b) software, interfacing, parts or supplies not supplied by HP, (c) unauthorized modification or misuse, (d) operation outside of the published environmental specifications for the product, (e) improper site preparation or maintenance, or (f) damage to HP product as a result of the use of non-HP Toner Reload Kits, refilled HP Toner Reload Kits, non-HP Toner, non-HP Laser Imaging Drums, non-HP internal product components, or paper with a high talc or calcium or other easily transferable residue substance.

TO THE EXTENT ALLOWED BY LOCAL LAW, THE ABOVE WARRANTIES ARE EXCLUSIVE AND NO OTHER WARRANTY OR CONDITION, WHETHER WRITTEN OR ORAL, IS EXPRESSED OR IMPLIED AND HP SPECIFICALLY DISCLAIMS ANY IMPLIED WARRANTIES OR CONDITIONS OF MERCHANTABILITY, SATISFACTORY QUALITY, AND FITNESS FOR A PARTICULAR PURPOSE. Some countries/regions, states or provinces do not allow limitations on the duration of an implied warranty, so the above limitation or exclusion might not apply to you. This warranty gives you specific legal rights and you might also have other rights that vary from country/region to country/region, state to state, or province to province.

HP's limited warranty is valid in any country/region or locality where HP has a support presence for this product and where HP has marketed this product. The level of warranty service you receive may vary according to local standards. HP will not alter form, fit or function of the product to make it operate in a country/region for which it was never intended to function for legal or regulatory reasons.

TO THE EXTENT ALLOWED BY LOCAL LAW, THE REMEDIES IN THIS WARRANTY STATEMENT ARE YOUR SOLE AND EXCLUSIVE REMEDIES. EXCEPT AS INDICATED ABOVE, IN NO EVENT WILL HP OR ITS SUPPLIERS BE LIABLE FOR LOSS OF DATA OR FOR DIRECT, SPECIAL, INCIDENTAL, CONSEQUENTIAL (INCLUDING LOST PROFIT OR DATA), OR OTHER DAMAGE, WHETHER BASED IN CONTRACT, TORT, OR OTHERWISE. Some countries/regions, states or

provinces do not allow the exclusion or limitation of incidental or consequential damages, so the above limitation or exclusion may not apply to you.

THE WARRANTY TERMS CONTAINED IN THIS STATEMENT, EXCEPT TO THE EXTENT LAWFULLY PERMITTED, DO NOT EXCLUDE, RESTRICT OR MODIFY AND ARE IN ADDITION TO THE MANDATORY STATUTORY RIGHTS APPLICABLE TO THE SALE OF THIS PRODUCT TO YOU.

UK, Ireland, and Malta

The HP Limited Warranty is a commercial guarantee voluntarily provided by HP. The name and address of the HP entity responsible for the performance of the HP Limited Warranty in your country/region is as follows:

UK: HP Inc UK Limited, Cain Road, Amen Corner, Bracknell, Berkshire, RG12 1HN

Ireland: Hewlett-Packard Ireland Limited, Liffey Park Technology Campus, Barnhall Road, Leixlip, Co.Kildare

Malta: Hewlett-Packard Europe B.V., Amsterdam, Meyrin Branch, Route du Nant-d'Avril 150, 1217 Meyrin, Switzerland

United Kingdom: The HP Limited Warranty benefits apply in addition to any legal rights to a guarantee from seller of nonconformity of goods with the contract of sale. These rights expire six years from delivery of goods for products purchased in England or Wales and five years from delivery of goods for products purchased in Scotland. However various factors may impact your eligibility to receive these rights. For further information, please consult the following link: Consumer Legal Guarantee (www.hp.com/go/eu-legal) or you may visit the European Consumer Centers website (http://ec.europa.eu/consumers/solving_consumer_disputes/non-judicial_redress/ecc-net/index_en.htm). Consumers have the right to choose whether to claim service under the HP Limited Warranty or against the seller under the legal guarantee.

Ireland: The HP Limited Warranty benefits apply in addition to any statutory rights from seller in relation to nonconformity of goods with the contract of sale. However various factors may impact your eligibility to receive these rights. Consumer statutory rights are not limited or affected in any manner by HP Care Pack. For further information, please consult the following link: Consumer Legal Guarantee (www.hp.com/go/eu-legal) or you may visit the European Consumer Centers website (http://ec.europa.eu/consumers/solving_consumer_disputes/non-judicial_redress/ecc-net/index_en.htm). Consumers have the right to choose whether to claim service under the HP Limited Warranty or against the seller under the legal guarantee.

Malta: The HP Limited Warranty benefits apply in addition to any legal rights to a two-year guarantee from seller of nonconformity of goods with the contract of sale; however various factors may impact your eligibility to receive these rights. Consumer statutory rights are not limited or affected in any manner by the HP Limited Warranty. For further information, please consult the following link: Consumer Legal Guarantee (www.hp.com/go/eu-legal) or you may visit the European Consumer Centers website (http://ec.europa.eu/consumers/solving_consumer_disputes/non-judicial_redress/ecc-net/index_en.htm). Consumers have the right to choose whether to claim service under the HP Limited Warranty or against the seller under two-year legal guarantee.

Austria, Belgium, Germany, and Luxembourg

Die beschränkte HP Herstellergarantie ist eine von HP auf freiwilliger Basis angebotene kommerzielle Garantie. Der Name und die Adresse der HP Gesellschaft, die in Ihrem Land für die Gewährung der beschränkten HP Herstellergarantie verantwortlich ist, sind wie folgt:

Deutschland: HP Deutschland GmbH, Schickardstr. 32, D-71034 Böblingen

Österreich: HP Austria GmbH., Technologiestrasse 5, A-1120 Wien

Luxemburg: Hewlett-Packard Luxembourg S.C.A., 75, Parc d'Activités Capellen, Rue Pafebruc, L-8308 Capellen

Belgien: HP Belgium BVBA, Hermeslaan 1A, B-1831 Diegem

Die Rechte aus der beschränkten HP Herstellergarantie gelten zusätzlich zu den gesetzlichen Ansprüchen wegen Sachmängeln auf eine zweijährige Gewährleistung ab dem Lieferdatum. Ob Sie Anspruch auf diese

Rechte haben, hängt von zahlreichen Faktoren ab. Die Rechte des Kunden sind in keiner Weise durch die beschränkte HP Herstellergarantie eingeschränkt bzw. betroffen. Weitere Hinweise finden Sie auf der folgenden Website: Gewährleistungsansprüche für Verbraucher (www.hp.com/go/eu-legal) oder Sie können die Website des Europäischen Verbraucherzentrums (http://ec.europa.eu/consumers/solving_consumer_disputes/non-judicial_redress/ecc-net/index_en.htm) besuchen. Verbraucher haben das Recht zu wählen, ob sie eine Leistung von HP gemäß der beschränkten HP Herstellergarantie in Anspruch nehmen oder ob sie sich gemäß der gesetzlichen zweijährigen Haftung für Sachmängel (Gewährleistung) sich an den jeweiligen Verkäufer wenden.

Belgium, France, and Luxemburg

La garantie limitée HP est une garantie commerciale fournie volontairement par HP. Voici les coordonnées de l'entité HP responsable de l'exécution de la garantie limitée HP dans votre pays:

France: HP France SAS, société par actions simplifiée identifiée sous le numéro 448 694 133 RCS Evry, 1 Avenue du Canada, 91947, Les Ulis

G.D. Luxembourg: Hewlett-Packard Luxembourg S.C.A., 75, Parc d'Activités Capellen, Rue Pafebruc, L-8308 Capellen

Belgique: HP Belgium BVBA, Hermeslaan 1A, B-1831 Diegem

France: Les avantages de la garantie limitée HP s'appliquent en complément des droits dont vous disposez au titre des garanties légales applicables dont le bénéfice est soumis à des conditions spécifiques. Vos droits en tant que consommateur au titre de la garantie légale de conformité mentionnée aux articles L. 211-4 à L. 211-13 du Code de la Consommation et de celle relatives aux défauts de la chose vendue, dans les conditions prévues aux articles 1641 à 1648 et 2232 du Code de Commerce ne sont en aucune façon limités ou affectés par la garantie limitée HP. Pour de plus amples informations, veuillez consulter le lien suivant : Garanties légales accordées au consommateur (www.hp.com/go/eu-legal). Vous pouvez également consulter le site Web des Centres européens des consommateurs (http://ec.europa.eu/consumers/solving_consumer_disputes/non-judicial_redress/ecc-net/index_en.htm). Les consommateurs ont le droit de choisir d'exercer leurs droits au titre de la garantie limitée HP, ou auprès du vendeur au titre des garanties légales applicables mentionnées ci-dessus.

POUR RAPPEL:

Garantie Légale de Conformité:

« Le vendeur est tenu de livrer un bien conforme au contrat et répond des défauts de conformité existant lors de la délivrance.

Il répond également des défauts de conformité résultant de l'emballage, des instructions de montage ou de l'installation lorsque celle-ci a été mise à sa charge par le contrat ou a été réalisée sous sa responsabilité ».

Article L211-5 du Code de la Consommation:

« Pour être conforme au contrat, le bien doit:

1° Etre propre à l'usage habituellement attendu d'un bien semblable et, le cas échéant:

- correspondre à la description donnée par le vendeur et posséder les qualités que celui-ci a présentées à l'acheteur sous forme d'échantillon ou de modèle;

- présenter les qualités qu'un acheteur peut légitimement attendre eu égard aux déclarations publiques faites par le vendeur, par le producteur ou par son représentant, notamment dans la publicité ou l'étiquetage;

2° Ou présenter les caractéristiques définies d'un commun accord par les parties ou être propre à tout usage spécial recherché par l'acheteur, porté à la connaissance du vendeur et que ce dernier a accepté ».

Article L211-12 du Code de la Consommation:

« L'action résultant du défaut de conformité se prescrit par deux ans à compter de la délivrance du bien ».

Garantie des vices cachés

Article 1641 du Code Civil : *« Le vendeur est tenu de la garantie à raison des défauts cachés de la chose vendue qui la rendent impropre à l'usage auquel on la destine, ou qui diminuent tellement cet usage que l'acheteur ne l'aurait pas acquise, ou n'en aurait donné qu'un moindre prix, s'il les avait connus. »*

Article 1648 alinéa 1 du Code Civil:

« L'action résultant des vices rédhibitoires doit être intentée par l'acquéreur dans un délai de deux ans à compter de la découverte du vice. »

G.D. Luxembourg et Belgique: Les avantages de la garantie limitée HP s'appliquent en complément des droits dont vous disposez au titre de la garantie de non-conformité des biens avec le contrat de vente. Cependant, de nombreux facteurs peuvent avoir un impact sur le bénéfice de ces droits. Vos droits en tant que consommateur au titre de ces garanties ne sont en aucune façon limités ou affectés par la garantie limitée HP. Pour de plus amples informations, veuillez consulter le lien suivant : Garanties légales accordées au consommateur (www.hp.com/go/eu-legal) ou vous pouvez également consulter le site Web des Centres européens des consommateurs (http://ec.europa.eu/consumers/olving_consumer_disputes/non-judicial_redress/ecc-net/index_en.htm). Les consommateurs ont le droit de choisir de réclamer un service sous la garantie limitée HP ou auprès du vendeur au cours d'une garantie légale de deux ans.

Italy

La Garanzia limitata HP è una garanzia commerciale fornita volontariamente da HP. Di seguito sono indicati nome e indirizzo della società HP responsabile della fornitura dei servizi coperti dalla Garanzia limitata HP nel vostro Paese:

Italia: HP Italy S.r.l., Via G. Di Vittorio 9, 20063 Cernusco S/Naviglio

I vantaggi della Garanzia limitata HP vengono concessi ai consumatori in aggiunta ai diritti derivanti dalla garanzia di due anni fornita dal venditore in caso di non conformità dei beni rispetto al contratto di vendita. Tuttavia, diversi fattori possono avere un impatto sulla possibilità di beneficiare di tali diritti. I diritti spettanti ai consumatori in forza della garanzia legale non sono in alcun modo limitati, né modificati dalla Garanzia limitata HP. Per ulteriori informazioni, si prega di consultare il seguente link: Garanzia legale per i clienti (www.hp.com/go/eu-legal), oppure visitare il sito Web dei Centri europei per i consumatori (http://ec.europa.eu/consumers/olving_consumer_disputes/non-judicial_redress/ecc-net/index_en.htm). I consumatori hanno il diritto di scegliere se richiedere un servizio usufruendo della Garanzia limitata HP oppure rivolgendosi al venditore per far valere la garanzia legale di due anni.

Spain

Su Garantía limitada de HP es una garantía comercial voluntariamente proporcionada por HP. El nombre y dirección de las entidades HP que proporcionan la Garantía limitada de HP (garantía comercial adicional del fabricante) en su país es:

España: Hewlett-Packard Española S.L. Calle Vicente Aleixandre, 1 Parque Empresarial Madrid - Las Rozas, E-28232 Madrid

Los beneficios de la Garantía limitada de HP son adicionales a la garantía legal de 2 años a la que los consumidores tienen derecho a recibir del vendedor en virtud del contrato de compraventa; sin embargo, varios factores pueden afectar su derecho a recibir los beneficios bajo dicha garantía legal. A este respecto, la Garantía limitada de HP no limita o afecta en modo alguno los derechos legales del consumidor (www.hp.com/go/eu-legal). Para más información, consulte el siguiente enlace: Garantía legal del

consumidor o puede visitar el sitio web de los Centros europeos de los consumidores (http://ec.europa.eu/consumers/solving_consumer_disputes/non-judicial_redress/ecc-net/index_en.htm). Los clientes tienen derecho a elegir si reclaman un servicio acogiéndose a la Garantía limitada de HP o al vendedor de conformidad con la garantía legal de dos años.

Denmark

Den begrænsede HP-garanti er en garanti, der ydes frivilligt af HP. Navn og adresse på det HP-selskab, der er ansvarligt for HP's begrænsede garanti i dit land, er som følger:

Danmark: HP Inc Danmark ApS, Engholm Parkvej 8, 3450, Allerød

Den begrænsede HP-garanti gælder i tillæg til eventuelle juridiske rettigheder, for en toårig garanti fra sælgeren af varer, der ikke er i overensstemmelse med salgsaftalen, men forskellige faktorer kan dog påvirke din ret til at opnå disse rettigheder. Forbrugerens lovbestemte rettigheder begrænses eller påvirkes ikke på nogen måde af den begrænsede HP-garanti. Se nedenstående link for at få yderligere oplysninger: Forbrugerens juridiske garanti (www.hp.com/go/eu-legal) eller du kan besøge De Europæiske Forbrugercentres websted (http://ec.europa.eu/consumers/solving_consumer_disputes/non-judicial_redress/ecc-net/index_en.htm). Forbrugere har ret til at vælge, om de vil gøre krav på service i henhold til HP's begrænsede garanti eller hos sælger i henhold til en toårig juridisk garanti.

Norway

HPs garanti er en begrenset og kommersiell garanti som HP selv har valgt å tilby. Følgende lokale selskap innestår for garantien:

Norge: HP Norge AS, Rolfbuktveien 4b, 1364 Fornebu

HPs garanti kommer i tillegg til det mangelsansvar HP har i henhold til norsk forbrukerkjøpslovgivning, hvor reklamasjonsperioden kan være to eller fem år, avhengig av hvor lenge salgsgjenstanden var ment å vare. Ulike faktorer kan imidlertid ha betydning for om du kvalifiserer til å kreve avhjelp iht slikt mangelsansvar. Forbrukerens lovmessige rettigheter begrenses ikke av HPs garanti. Hvis du vil ha mer informasjon, kan du klikke på følgende kobling: Juridisk garanti for forbruker (www.hp.com/go/eu-legal) eller du kan besøke nettstedet til de europeiske forbrukersentrene (http://ec.europa.eu/consumers/solving_consumer_disputes/non-judicial_redress/ecc-net/index_en.htm). Forbrukere har retten til å velge å kreve service under HPs garanti eller iht selgerens lovpålagte mangelsansvar.

Sweden

HP:s begränsade garanti är en kommersiell garanti som tillhandahålls frivilligt av HP. Namn och adress till det HP-företag som ansvarar för HP:s begränsade garanti i ditt land är som följer:

Sverige: HP PPS Sverige AB, SE-169 73 Stockholm

Fördelarna som ingår i HP:s begränsade garanti gäller utöver de lagstadgade rättigheterna till tre års garanti från säljaren angående varans bristande överensstämmelse gentemot köpeavtalet, men olika faktorer kan påverka din rätt att utnyttja dessa rättigheter. Konsumentens lagstadgade rättigheter varken begränsas eller påverkas på något sätt av HP:s begränsade garanti. Mer information får du om du följer denna länk: Lagstadgad garanti för konsumenter (www.hp.com/go/eu-legal) eller så kan du gå till European Consumer Centers webbplats (http://ec.europa.eu/consumers/solving_consumer_disputes/non-judicial_redress/ecc-net/index_en.htm). Konsumenter har rätt att välja om de vill ställa krav enligt HP:s begränsade garanti eller på säljaren enligt den lagstadgade treåriga garantin.

Portugal

A Garantia Limitada HP é uma garantia comercial fornecida voluntariamente pela HP. O nome e a morada da entidade HP responsável pela prestação da Garantia Limitada HP no seu país são os seguintes:

Portugal: HPCP – Computing and Printing Portugal, Unipessoal, Lda., Edifício D. Sancho I, Quinta da Fonte, Porto Salvo, Lisboa, Oeiras, 2740 244

As vantagens da Garantia Limitada HP aplicam-se cumulativamente com quaisquer direitos decorrentes da legislação aplicável à garantia de dois anos do vendedor, relativa a defeitos do produto e constante do contrato de venda. Existem, contudo, vários fatores que poderão afetar a sua elegibilidade para beneficiar de tais direitos. Os direitos legalmente atribuídos aos consumidores não são limitados ou afetados de forma alguma pela Garantia Limitada HP. Para mais informações, consulte a ligação seguinte: Garantia legal do consumidor (www.hp.com/go/eu-legal) ou visite o Web site da Rede dos Centros Europeus do Consumidor (http://ec.europa.eu/consumers/solving_consumer_disputes/non-judicial_redress/ecc-net/index_en.htm). Os consumidores têm o direito de escolher se pretendem reclamar assistência ao abrigo da Garantia Limitada HP ou contra o vendedor ao abrigo de uma garantia jurídica de dois anos.

Greece and Cyprus

Η Περιορισμένη εγγύηση HP είναι μια εμπορική εγγύηση η οποία παρέχεται εθελοντικά από την HP. Η επωνυμία και η διεύθυνση του νομικού προσώπου HP που παρέχει την Περιορισμένη εγγύηση HP στη χώρα σας είναι η εξής:

Ελλάδα /Κύπρος: HP Printing and Personal Systems Hellas EPE, Tzavella 1-3, 15232 Chalandri, Attiki

Ελλάδα /Κύπρος: HP Συστήματα Εκτύπωσης και Προσωπικών Υπολογιστών Ελλάς Εταιρεία Περιορισμένης Ευθύνης, Tzavella 1-3, 15232 Chalandri, Attiki

Τα προνόμια της Περιορισμένης εγγύησης HP ισχύουν επιπλέον των νόμιμων δικαιωμάτων για διετή εγγύηση έναντι του Πωλητή για τη μη συμμόρφωση των προϊόντων με τις συνομολογημένες συμβατικά ιδιότητες, ωστόσο η άσκηση των δικαιωμάτων σας αυτών μπορεί να εξαρτάται από διάφορους παράγοντες. Τα νόμιμα δικαιώματα των καταναλωτών δεν περιορίζονται ούτε επηρεάζονται καθ' οιονδήποτε τρόπο από την Περιορισμένη εγγύηση HP. Για περισσότερες πληροφορίες, συμβουλευτείτε την ακόλουθη τοποθεσία web: Νόμιμη εγγύηση καταναλωτή (www.hp.com/go/eu-legal) ή μπορείτε να επισκεφτείτε την τοποθεσία web των Ευρωπαϊκών Κέντρων Καταναλωτή (http://ec.europa.eu/consumers/solving_consumer_disputes/non-judicial_redress/ecc-net/index_en.htm). Οι καταναλωτές έχουν το δικαίωμα να επιλέξουν αν θα αξιώσουν την υπηρεσία στα πλαίσια της Περιορισμένης εγγύησης HP ή από τον πωλητή στα πλαίσια της νόμιμης εγγύησης δύο ετών.

Hungary

A HP korlátozott jótállás egy olyan kereskedelmi jótállás, amelyet a HP a saját elhatározásából biztosít. Az egyes országokban a HP mint gyártó által vállalt korlátozott jótállást biztosító HP vállalatok neve és címe:

Magyarország: HP Inc Magyarország Kft., H-1117 Budapest, Alíz utca 1.

A HP korlátozott jótállásban biztosított jogok azokon a jogokon felül illetik meg Önt, amelyek a termékeknek az adásvételi szerződés szerinti minőségére vonatkozó kétéves, jogszabályban foglalt eladói szavatosságból, továbbá ha az Ön által vásárolt termékre alkalmazandó, a jogszabályban foglalt kötelező eladói jótállásból erednek, azonban számos körülmény hatással lehet arra, hogy ezek a jogok Önt megilletik-e. További információért kérjük, keresse fel a következő webhelyet: Jogi Tájékoztató Fogyasztóknak (www.hp.com/go/eu-legal) vagy látogassa meg az Európai Fogyasztói Központok webhelyét (http://ec.europa.eu/consumers/solving_consumer_disputes/non-judicial_redress/ecc-net/index_en.htm). A fogyasztóknak jogában áll, hogy megválasszák, hogy a jótállással kapcsolatos igényüket a HP korlátozott jótállás alapján

vagy a kétéves, jogszabályban foglalt eladói szavatosság, illetve, ha alkalmazandó, a jogszabályban foglalt kötelező eladói jótállás alapján érvényesítik.

Czech Republic

Omezená záruka HP je obchodní zárukou dobrovolně poskytovanou společností HP. Názvy a adresy společností skupiny HP, které odpovídají za plnění omezené záruky HP ve vaší zemi, jsou následující:

Česká republika: HP Inc Czech Republic s. r. o., Za Brumlovkou 5/1559, 140 00 Praha 4

Výhody, poskytované omezenou zárukou HP, se uplatňují jako doplněk k jakýmkoli právním nárokům na dvouletou záruku poskytnutou prodejcem v případě nesouladu zboží s kupní smlouvou. Váš nárok na uznání těchto práv však může záviset na mnohých faktorech. Omezená záruka HP žádným způsobem neomezuje ani neovlivňuje zákonná práva zákazníka. Další informace získáte kliknutím na následující odkaz: Zákonná záruka spotřebitele (www.hp.com/go/eu-legal) případně můžete navštívit webové stránky Evropského spotřebitelského centra (http://ec.europa.eu/consumers/solving_consumer_disputes/non-judicial_redress/ecc-net/index_en.htm). Spotřebitelé mají právo se rozhodnout, zda chtějí službu reklamovat v rámci omezené záruky HP nebo v rámci zákonem stanovené dvouleté záruky u prodejce.

Slovakia

Obmedzená záruka HP je obchodná záruka, ktorú spoločnosť HP poskytuje dobrovoľne. Meno a adresa subjektu HP, ktorý zabezpečuje plnenie vyplývajúce z Obmedzenej záruky HP vo vašej krajine:

Slovenská republika: HP Inc Slovakia, s.r.o., Galvaniho 7, 821 04 Bratislava

Výhody Obmedzenej záruky HP sa uplatnia vedľa prípadných zákazníkovoých zákonných nárokov voči predávajúcemu z väd, ktoré spočívajú v nesúlade vlastností tovaru s jeho popisom podľa predmetnej zmluvy. Možnosť uplatnenia takých prípadných nárokov však môže závisieť od rôznych faktorov. Služby Obmedzenej záruky HP žiadnym spôsobom neobmedzujú ani neovplyvňujú zákonné práva zákazníka, ktorý je spotrebiteľom. Ďalšie informácie nájdete na nasledujúcom prepojení: Zákonná záruka spotrebiteľa (www.hp.com/go/eu-legal), prípadne môžete navštíviť webovú lokalitu európskych zákazníckych stredísk (http://ec.europa.eu/consumers/solving_consumer_disputes/non-judicial_redress/ecc-net/index_en.htm). Spotrebiteľia majú právo zvoliť si, či chcú uplatniť servis v rámci Obmedzenej záruky HP alebo počas zákonnej dvojročnej záručnej lehoty u predajcu.

Poland

Ograniczona gwarancja HP to komercyjna gwarancja udzielona dobrowolnie przez HP. Nazwa i adres podmiotu HP odpowiedzialnego za realizację Ograniczonej gwarancji HP w Polsce:

Polska: HP Inc Polska sp. z o.o., Szturmowa 2a, 02-678 Warszawa, wpisana do rejestru przedsiębiorców prowadzonego przez Sąd Rejonowy dla m.st. Warszawy w Warszawie, XIII Wydział Gospodarczy Krajowego Rejestru Sądowego, pod numerem KRS 0000546115, NIP 5213690563, REGON 360916326, GIOŚ E0020757WZBW, kapitał zakładowy 480.000 PLN.

Świadczenia wynikające z Ograniczonej gwarancji HP stanowią dodatek do praw przysługujących nabywcy w związku z dwuletnią odpowiedzialnością sprzedawcy z tytułu niezgodności towaru z umową (rękojmia). Niemniej, na możliwość korzystania z tych praw mają wpływ różne czynniki. Ograniczona gwarancja HP w żaden sposób nie ogranicza praw konsumenta ani na nie nie wpływa. Więcej informacji można znaleźć pod następującym łączem: Gwarancja prawna konsumenta (www.hp.com/go/eu-legal), można także odwiedzić stronę internetową Europejskiego Centrum Konsumentckiego (http://ec.europa.eu/consumers/solving_consumer_disputes/non-judicial_redress/ecc-net/index_en.htm). Konsumentci mają prawo wyboru co do możliwości skorzystania albo z usług gwarancyjnych przysługujących w ramach Ograniczonej gwarancji HP albo z uprawnień wynikających z dwuletniej rękojmi w stosunku do sprzedawcy.

Bulgaria

Ограничената гаранция на HP представлява търговска гаранция, доброволно предоставяна от HP. Името и адресът на дружеството на HP за вашата страна, отговорно за предоставянето на гаранционната поддръжка в рамките на Ограничената гаранция на HP, са както следва:

HP Inc Bulgaria EOOD (Ейч Пи Инк България ЕООД), гр. София 1766, район р-н Младост, бул. Околовръстен Път No 258, Бизнес Център Камбаните

Предимствата на Ограничената гаранция на HP се прилагат в допълнение към всички законови права за двугодишна гаранция от продавача при несъответствие на стоката с договора за продажба. Въпреки това, различни фактори могат да окажат влияние върху условията за получаване на тези права. Законовите права на потребителите не са ограничени или засегнати по никакъв начин от Ограничената гаранция на HP. За допълнителна информация, моля вижте Правната гаранция на потребителя (www.hp.com/go/eu-legal) или посетете уебсайта на Европейския потребителски център (http://ec.europa.eu/consumers/solving_consumer_disputes/non-judicial_redress/ecc-net/index_en.htm). Потребителите имат правото да избират дали да претендират за извършване на услуга в рамките на Ограничената гаранция на HP или да потърсят такава от търговеца в рамките на двугодишната правна гаранция.

Romania

Garanția limitată HP este o garanție comercială furnizată în mod voluntar de către HP. Numele și adresa entității HP răspunzătoare de punerea în aplicare a Garanției limitate HP în țara dumneavoastră sunt următoarele:

România: HP Inc Romania SRL, 5 Fabrica de Glucoza Str., Building F, Ground Floor and Floor 8, 2nd District, București

Beneficiile Garanției limitate HP se aplică suplimentar față de orice drepturi privind garanția de doi ani oferită de vânzător pentru neconformitatea bunurilor cu contractul de vânzare; cu toate acestea, diversi factori pot avea impact asupra eligibilității dvs. de a beneficia de aceste drepturi. Drepturile legale ale consumatorului nu sunt limitate sau afectate în vreun fel de Garanția limitată HP. Pentru informații suplimentare consultați următorul link: гаранцията acordată потребителите по закон (www.hp.com/go/eu-legal) или можете да посетите сайта на Европейския център за решаване на спорове на потребителите (http://ec.europa.eu/consumers/solving_consumer_disputes/non-judicial_redress/ecc-net/index_en.htm). Потребителите имат правото да изберат дали да претендират за извършване на услуга в рамките на Ограничената гаранция на HP или да потърсят такава от търговеца в рамките на двугодишната правна гаранция.

Belgium and the Netherlands

De Beperkte Garantie van HP is een commerciële garantie vrijwillig verstrekt door HP. De naam en het adres van de HP-entiteit die verantwoordelijk is voor het uitvoeren van de Beperkte Garantie van HP in uw land is als volgt:

Nederland: HP Nederland B.V., Startbaan 16, 1187 XR Amstelveen

België: HP Belgium BVBA, Hermeslaan 1A, B-1831 Diegem

De voordelen van de Beperkte Garantie van HP vormen een aanvulling op de wettelijke garantie voor consumenten gedurende twee jaren na de levering te verlenen door de verkoper bij een gebrek aan conformiteit van de goederen met de relevante verkoopovereenkomst. Niettemin kunnen diverse factoren een impact hebben op uw eventuele aanspraak op deze wettelijke rechten. De wettelijke rechten van de consument worden op geen enkele wijze beperkt of beïnvloed door de Beperkte Garantie van HP. Raadpleeg voor meer informatie de volgende webpagina: Wettelijke garantie van de consument (www.hp.com/go/eu-legal) of u kan de website van het Europees Consumenten Centrum bezoeken (http://ec.europa.eu/consumers/solving_consumer_disputes/non-judicial_redress/ecc-net/index_en.htm). Consumenten hebben

het recht om te kiezen tussen enerzijds de Beperkte Garantie van HP of anderzijds het aanspreken van de verkoper in toepassing van de wettelijke garantie.

Finland

HP:n rajoitettu takuu on HP:n vapaaehtoisesti antama kaupallinen takuu. HP:n myöntämästä takuusta maassanne vastaavan HP:n edustajan yhteystiedot ovat:

Suomi: HP Finland Oy, Piispankalliontie, FIN - 02200 Espoo

HP:n takuun edut ovat voimassa mahdollisten kuluttajansuojalakiin perustuvien oikeuksien lisäksi sen varalta, että tuote ei vastaa myyntisopimusta. Saat lisätietoja seuraavasta linkistä: Kuluttajansuoja (www.hp.com/go/eu-legal) tai voit käydä Euroopan kuluttajakeskuksen sivustolla (http://ec.europa.eu/consumers/solving_consumer_disputes/non-judicial_redress/ecc-net/index_en.htm). Kuluttajilla on oikeus vaatia virheen korjausta HP:n takuun ja kuluttajansuojan perusteella HP:lta tai myyjältä.

Slovenia

Omejena garancija HP je prostovoljna trgovska garancija, ki jo zagotavlja podjetje HP. Ime in naslov poslovne enote HP, ki je odgovorna za omejeno garancijo HP v vaši državi, sta naslednja:

Slovenija: Hewlett-Packard Europe B.V., Amsterdam, Meyrin Branch, Route du Nant-d'Avril 150, 1217 Meyrin, Switzerland

Ugodnosti omejene garancije HP veljajo poleg zakonskih pravic, ki ob sklenitvi kupoprodajne pogodbe izhajajo iz dveletne garancije prodajalca v primeru neskladnosti blaga, vendar lahko na izpolnjevanje pogojev za uveljavitev pravic vplivajo različni dejavniki. Omejena garancija HP nikakor ne omejuje strankinih z zakonom predpisanih pravic in ne vpliva nanje. Za dodatne informacije glejte naslednjo povezavo: Strankino pravno jamstvo (www.hp.com/go/eu-legal); ali pa obiščite spletno mesto evropskih središč za potrošnike (http://ec.europa.eu/consumers/solving_consumer_disputes/non-judicial_redress/ecc-net/index_en.htm). Potrošniki imajo pravico izbrati, ali bodo uveljavljali pravice do storitev v skladu z omejeno garancijo HP ali proti prodajalcu v skladu z dvoletno zakonsko garancijo.

Croatia

HP ograničeno jamstvo komercijalno je dobrovoljno jamstvo koje pruža HP. Ime i adresa HP subjekta odgovornog za HP ograničeno jamstvo u vašoj državi:

Hrvatska: HP Computing and Printing d.o.o. za računalne i srodne aktivnosti, Radnička cesta 41, 10000 Zagreb

Pogodnosti HP ograničenog jamstva vrijede zajedno uz sva zakonska prava na dvogodišnje jamstvo kod bilo kojeg prodavača s obzirom na nepodudaranje robe s ugovorom o kupnji. Međutim, razni faktori mogu utjecati na vašu mogućnost ostvarivanja tih prava. HP ograničeno jamstvo ni na koji način ne utječe niti ne ograničava zakonska prava potrošača. Dodatne informacije potražite na ovoj adresi: Zakonsko jamstvo za potrošače (www.hp.com/go/eu-legal) ili možete posjetiti web-mjesto Europskih potrošačkih centara (http://ec.europa.eu/consumers/solving_consumer_disputes/non-judicial_redress/ecc-net/index_en.htm). Potrošači imaju pravo odabrati žele li ostvariti svoja potraživanja u sklopu HP ograničenog jamstva ili pravnog jamstva prodavača u trajanju ispod dvije godine.

Latvia

HP ierobežotā garantija ir komercgarantija, kuru brīvprātīgi nodrošina HP. HP uzņēmums, kas sniedz HP ierobežotās garantijas servisa nodrošinājumu jūsu valstī:

Latvija: HP Finland Oy, PO Box 515, 02201 Espoo, Finland

HP ierobežotās garantijas priekšrocības tiek piedāvātas papildus jebkurām likumīgajām tiesībām uz pārdevēja un/vai ražotāju nodrošinātu divu gadu garantiju gadījumā, ja preces neatbilst pirkuma līgumam, tomēr šo tiesību saņemšanu var ietekmēt vairāki faktori. HP ierobežotā garantija nekādā veidā neierobežo un neietekmē patērētāju likumīgās tiesības. Lai iegūtu plašāku informāciju, izmantojiet šo saiti: Patērētāju likumīgā garantija (www.hp.com/go/eu-legal) vai arī Eiropas Patērētāju tiesību aizsardzības centra tīmekļa vietni (http://ec.europa.eu/consumers/solving_consumer_disputes/non-judicial_redress/ecc-net/index_en.htm). Patērētājiem ir tiesības izvēlēties, vai pieprasīt servisa nodrošinājumu saskaņā ar HP ierobežoto garantiju, vai arī pārdevēja sniegto divu gadu garantiju.

Lithuania

HP ribotoji garantija yra HP savanoriškai teikiama komercinė garantija. Toliau pateikiami HP bendrovių, teikiančių HP garantiją (gamintojo garantiją) jūsų šalyje, pavadinimai ir adresai:

Lietuva: HP Finland Oy, PO Box 515, 02201 Espoo, Finland

HP ribotoji garantija papildomai taikoma kartu su bet kokiais kitomis įstatymais nustatytais teisėmis į pardavėjo suteikiamą dviejų metų laikotarpio garantiją dėl prekių atitikties pardavimo sutarčiai, tačiau tai, ar jums ši teisė bus suteikiama, gali priklausyti nuo įvairių aplinkybių. HP ribotoji garantija niekaip neapriboja ir neįtakoja įstatymais nustatytų vartotojo teisių. Daugiau informacijos rasite paspaudę šią nuorodą: Teisinė vartotojo garantija (www.hp.com/go/eu-legal) arba apsilankę Europos vartotojų centro internetinėje svetainėje (http://ec.europa.eu/consumers/solving_consumer_disputes/non-judicial_redress/ecc-net/index_en.htm). Vartotojai turi teisę prašyti atlikti techninį aptarnavimą pagal HP ribotąją garantiją arba pardavėjo teikiamą dviejų metų įstatymais nustatytą garantiją.

Estonia

HP piiratud garantii on HP poolt vabatahtlikult pakutav kaubanduslik garantii. HP piiratud garantii eest vastutab HP üksus aadressil:

Eesti: HP Finland Oy, PO Box 515, 02201 Espoo, Finland

HP piiratud garantii rakendub lisaks seaduses ettenähtud müüjapoolsele kaheaastasele garantiile, juhul kui toode ei vasta müügilepingu tingimustele. Siiski võib esineda asjaolusid, mille puhul teie jaoks need õigused ei pruugi kehtida. HP piiratud garantii ei piira ega mõjuta mingil moel tarbija seadusjärgseid õigusi. Lisateavet leiate järgmiselt lingilt: tarbija õiguslik garantii (www.hp.com/go/eu-legal) või võite külastada Euroopa tarbijakeskuste veebisaiti (http://ec.europa.eu/consumers/solving_consumer_disputes/non-judicial_redress/ecc-net/index_en.htm). Tarbijal on õigus valida, kas ta soovib kasutada HP piiratud garantiid või seadusega ette nähtud müüjapoolset kaheaastast garantiid.

Russia

Срок службы принтера для России

Срок службы данного принтера HP составляет пять лет в нормальных условиях эксплуатации. Срок службы отсчитывается с момента ввода принтера в эксплуатацию. В конце срока службы HP рекомендует посетить веб-сайт нашей службы поддержки по адресу <http://www.hp.com/support> и/или связаться с авторизованным поставщиком услуг HP для получения рекомендаций в отношении дальнейшего безопасного использования принтера.

HP's Premium Protection Warranty: Neverstop Toner Reload Kit and HP Laser Imaging Drum limited warranty statement

This HP product is warranted to be free from defects in materials and workmanship.

This warranty does not apply to products that (a) have been refilled, refurbished, remanufactured or tampered with in any way, except for the use of an Toner Reload Kit as specified in the printer manual, (b) experience problems resulting from misuse, improper storage, or operation outside of the published environmental specifications for the printer product or (c) exhibit wear from ordinary use.

To obtain warranty service, please return the product to place of purchase (with a written description of the problem and print samples) or contact HP customer support. At HP's option, except where provided otherwise by local law, HP will either replace products that prove to be defective or refund your purchase price.

TO THE EXTENT ALLOWED BY LOCAL LAW, THE ABOVE WARRANTY IS EXCLUSIVE AND NO OTHER WARRANTY OR CONDITION, WHETHER WRITTEN OR ORAL, IS EXPRESSED OR IMPLIED AND HP SPECIFICALLY DISCLAIMS ANY IMPLIED WARRANTIES OR CONDITIONS OF MERCHANTABILITY, SATISFACTORY QUALITY, AND FITNESS FOR A PARTICULAR PURPOSE.

TO THE EXTENT ALLOWED BY LOCAL LAW, IN NO EVENT WILL HP OR ITS SUPPLIERS BE LIABLE FOR DIRECT, SPECIAL, INCIDENTAL, CONSEQUENTIAL (INCLUDING LOST PROFIT OR DATA), OR OTHER DAMAGE, WHETHER BASED IN CONTRACT, TORT, OR OTHERWISE.

THE WARRANTY TERMS CONTAINED IN THIS STATEMENT, EXCEPT TO THE EXTENT LAWFULLY PERMITTED, DO NOT EXCLUDE, RESTRICT OR MODIFY AND ARE IN ADDITION TO THE MANDATORY STATUTORY RIGHTS APPLICABLE TO THE SALE OF THIS PRODUCT TO YOU.

HP policy on non-HP supplies

HP cannot recommend the use of non-HP Toner Reload Kits, non-HP toner, non-HP Laser Imaging Drums, and non-HP imaging system components, either new or remanufactured.



NOTE: For HP Neverstop Laser products, warranty does not cover printer or imaging drum failures or complications due to damage, contaminations, or general print related defects from use of non-HP Toner Reload Kits, non-HP Toner, non-HP Laser Imaging Drums, or non-HP Laser Imaging Drum components. In such case, HP will charge its standard time and materials charges to service the printer for the particular failure or damage.

HP anticounterfeit Web site

Go to www.hp.com/go/anticounterfeit if you install an HP Toner Reload Kit or an HP Laser Imaging Drum and a software or firmware message indicates that you have installed a previously used reload kit or imaging drum. HP will help determine if the reload kit or imaging drum is genuine and take steps to resolve the problem.

Your reload kit or imaging drum might not be a genuine HP Toner Reload Kit or HP Laser Imaging Drum if you notice the following:

- The supplies status page indicates that a non-HP supply, or a used or counterfeit supply, is installed or has been used.
- A software or firmware message indicates that a non-HP supply, or a used or counterfeit supply, is installed or has been used.
- You are experiencing a high number of problems with the reload kit or imaging drum.
- The reload kit or imaging drum does not look like it usually does (for example, the packaging differs from HP packaging).

Data stored on the HP Toner Reload Kit and the HP Laser Imaging Drum

The HP Toner Reload Kits and HP Laser Imaging Drums used with this product contain memory chips that assist in the operation of the product.

In addition, these memory chips collect a limited set of information about the usage of the product, which might include the following: the date when the Toner Reload Kit and the imaging drum were first installed, the date when the Toner Reload Kit and the imaging drum were last used, the number of pages printed using the Toner Reload Kit and the imaging drum, the page coverage, the printing modes used, any printing errors that might have occurred, the product model, if a used or counterfeit Toner Reload Kit or imaging drum has been used, if a user has caused a cancellation of a reload process with a Toner Reload Kit, and if more than one cancellation has occurred with the same Toner Reload Kit. This information helps HP design future products to meet our customers' printing needs and will only be used in accordance with the HP Privacy Statement (www.hp.com/go/privacy).

The data collected from these memory chips does not contain information that can be used to identify a customer or user of the Toner Reload Kit or the imaging drum or his or her product, nor will any attempt to identify the customer be made.

HP collects a sampling of the memory chips from Toner Reload Kits and imaging drums returned to HP's free return and recycling program (HP Planet Partners: www.hp.com/recycle). The memory chips from this sampling are read and studied in order to improve future HP products. HP partners who assist in recycling these Toner Reload Kits and imaging drums might have access to this data, as well. All HP Partners are bound to adhere to all applicable data privacy laws and regulations.

Any third party possessing a used Toner Reload Kit or imaging drum might have access to the anonymous information on the memory chip.

End User License Agreement

READ CAREFULLY BEFORE USING THIS SOFTWARE EQUIPMENT: This End-User license Agreement ("EULA") is a legal agreement between (a) you (either an individual or a single entity) and (b) HP Inc. ("HP") that governs your use of any Software Product, installed on or made available by HP for use with your HP product ("HP Product"), that is not otherwise subject to a separate license agreement between you and HP or its suppliers. Other software may contain a EULA in its online documentation. The term "Software Product" means computer software and may include associated media, printed materials and "online" or electronic documentation.

An amendment or addendum to this EULA may accompany the HP Product.

RIGHTS IN THE SOFTWARE PRODUCT ARE OFFERED ONLY ON THE CONDITION THAT YOU AGREE TO ALL TERMS AND CONDITIONS OF THIS EULA. BY INSTALLING, COPYING, DOWNLOADING, OR OTHERWISE USING THE SOFTWARE PRODUCT, YOU AGREE TO BE BOUND BY THE TERMS OF THIS EULA. IF YOU DO NOT ACCEPT THESE LICENSE TERMS, YOUR SOLE REMEDY IS TO RETURN THE ENTIRE UNUSED PRODUCT (HARDWARE AND SOFTWARE) WITHIN 14 DAYS FOR A REFUND SUBJECT TO THE REFUND POLICY OF YOUR PLACE OF PURCHASE.

- 1. GRANT OF LICENSE.** HP grants you the following rights provided you comply with all terms and conditions of this EULA:
 - a. Use.** You may use the Software Product on a single computer ("Your Computer"). If the Software Product is provided to you via the internet and was originally licensed for use on more than one computer, you may install and use the Software Product only on those computers. You may not separate component parts of the Software Product for use on more than one computer. You do not have the right to distribute the Software Product. You may load the Software Product into Your Computer's temporary memory (RAM) for purposes of using the Software Product.
 - b. Storage.** You may copy the Software Product into the local memory or storage device of the HP Product.
 - c. Copying.** You may make archival or back-up copies of the Software Product, provided the copy contains all of the original Software Product's proprietary notices and that it is used only for back-up purposes.
 - d. Reservation of Rights.** HP and its suppliers reserve all rights not expressly granted to you in this EULA.
 - e. Freeware.** Notwithstanding the terms and conditions of this EULA, all or any portion of the Software Product which constitutes non-proprietary HP software or software provided under public license by third parties ("Freeware"), is licensed to you subject to the terms and conditions of the software license agreement accompanying such Freeware whether in the form of a discrete agreement, shrink wrap license or electronic license terms accepted at time of download. Use of the Freeware by you shall be governed entirely by the terms and conditions of such license.
 - f. Recovery Solution.** Any software recovery solution provided with/for your HP Product, whether in the form of a hard disk drive-based solution, an external media-based recovery solution (e.g. floppy disk, CD or DVD) or an equivalent solution delivered in any other form, may only be used for restoring the hard disk of the HP Product with/for which the recovery solution was originally

purchased. The use of any Microsoft operating system software contained in such recovery solution shall be governed by the Microsoft License Agreement.

- 2. UPGRADES.** To use a Software Product identified as an upgrade, you must first be licensed for the original Software Product identified by HP as eligible for the upgrade. After upgrading, you may no longer use the original Software Product that formed the basis for your upgrade eligibility. By using the Software Product, you also agree that HP may automatically access your HP Product when connected to the internet to check the version or status of certain Software Products and may automatically download and install upgrades or updates to such Software Products on to your HP Product to provide new versions or updates required to maintain the functionality, performance, or security of the HP Software and your HP Product and facilitate the provision of support or other services provided to you. In certain cases, and depending on the type of upgrade or update, notifications will be provided to you (via pop-up or other means), which may require you to initiate the upgrade or update.
- 3. ADDITIONAL SOFTWARE.** This EULA applies to updates or supplements to the original Software Product provided by HP unless HP provides other terms along with the update or supplement. In case of a conflict between such terms, the other terms will prevail.
- 4. TRANSFER.**
 - a.** Third Party. The initial user of the Software Product may make a one-time transfer of the Software Product to another end user. Any transfer must include all component parts, media, printed materials, this EULA, and if applicable, the Certificate of Authenticity. The transfer may not be an indirect transfer, such as a consignment. Prior to the transfer, the end user receiving the transferred product must agree to all the EULA terms. Upon transfer of the Software Product, your license is automatically terminated.
 - b.** Restrictions. You may not rent, lease or lend the Software Product or use the Software Product for commercial timesharing or bureau use. You may not sublicense, assign or transfer the license or Software Product except as expressly provided in this EULA.
- 5. PROPRIETARY RIGHTS.** All intellectual property rights in the Software Product and user documentation are owned by HP or its suppliers and are protected by law, including but not limited to United States copyright, trade secret, and trademark law, as well as other applicable laws and international treaty provisions. You shall not remove any product identification, copyright notices or proprietary restrictions from the Software Product.
- 6. LIMITATION ON REVERSE ENGINEERING.** You may not reverse engineer, decompile, or disassemble the Software Product, except and only to the extent that the right to do so is mandated under applicable law notwithstanding this limitation or it is expressly provided for in this EULA.
- 7. TERM.** This EULA is effective unless terminated or rejected. This EULA will also terminate upon conditions set forth elsewhere in this EULA or if you fail to comply with any term or condition of this EULA.
- 8. CONSENT TO COLLECTION/USE OF DATA.**
 - a.** HP will use cookies and other web technology tools to collect anonymous technical information related to HP Software and your HP Product. This data will be used to provide the upgrades and related support or other services described in Section 2. HP will also collect personal information including your Internet Protocol address or other unique identifier information associated with your HP Product and data provided by you on registration of your HP Product. As well as providing the upgrades and related support or other services, this data will be used for sending marketing communications to you (in each case with your express consent where required by applicable law).

To the extent permitted by applicable law, by accepting these terms and conditions you consent to the collection and use of anonymous and personal data by HP, its subsidiaries, and affiliates as described in this EULA and as further described in HP's privacy policy: www.hp.com/go/privacy

- b. **Collection/Use by Third Parties.** Certain software programs included in your HP Product are provided and separately licensed to you by third party providers ("Third Party Software"). Third Party Software may be installed and operational on your HP Product even if you choose not to activate/purchase such software. Third Party Software may collect and transmit technical information about your system (i.e., IP address, unique device identifier, software version installed, etc.) and other system data. This information is used by the third party to identify technical system attributes and ensure that the most current version of the software has been installed on your system. If you do not want the Third Party Software to collect this technical information or automatically send you version updates, you should uninstall the software prior to connecting to the Internet.

- 9. **DISCLAIMER OF WARRANTIES.** TO THE MAXIMUM EXTENT PERMITTED BY APPLICABLE LAW, HP AND ITS SUPPLIERS PROVIDE THE SOFTWARE PRODUCT "AS IS" AND WITH ALL FAULTS, AND HEREBY DISCLAIM ALL OTHER WARRANTIES, GUARANTEES, AND CONDITIONS, EITHER EXPRESS, IMPLIED, OR STATUTORY, INCLUDING, BUT NOT LIMITED TO, WARRANTIES OF TITLE AND NON-INFRINGEMENT, ANY IMPLIED WARRANTIES, DUTIES, GUARANTEES, OR CONDITIONS OF MERCHANTABILITY, OF SATISFACTORY QUALITY, OF FITNESS FOR A PARTICULAR PURPOSE, AND OF LACK OF VIRUSES ALL WITH REGARD TO THE SOFTWARE PRODUCT. Some states/jurisdictions do not allow exclusion of implied warranties or limitations on the duration of implied warranties, so the above disclaimer may not apply to you in its entirety.

IN AUSTRALIA AND NEW ZEALAND, THE SOFTWARE COMES WITH GUARANTEES THAT CANNOT BE EXCLUDED UNDER AUSTRALIAN AND NEW ZEALAND CONSUMER LAWS. AUSTRALIAN CONSUMERS ARE ENTITLED TO A REPLACEMENT OR A REFUND FOR A MAJOR FAILURE AND COMPENSATION FOR OTHER REASONABLY FORESEEABLE LOSS OR DAMAGE. AUSTRALIAN CONSUMERS ARE ALSO ENTITLED TO HAVE THE SOFTWARE REPAIRED OR REPLACED IF IT FAILS TO BE OF ACCEPTABLE QUALITY AND THE FAILURE DOES NOT AMOUNT TO A MAJOR FAILURE. NEW ZEALAND CONSUMERS WHO ARE PURCHASING GOODS FOR PERSONAL, DOMESTIC OR HOUSEHOLD USE OR CONSUMPTION AND NOT FOR THE PURPOSE OF A BUSINESS ("NEW ZEALAND CONSUMERS") ARE ENTITLED TO REPAIR, REPLACEMENT OR REFUND FOR A FAILURE AND COMPENSATION FOR OTHER REASONABLY FORESEEABLE LOSS OR DAMAGE.

- 10. **LIMITATION OF LIABILITY.** Subject to local law, notwithstanding any damages that you might incur, the entire liability of HP and any of its suppliers under any provision of this EULA and your exclusive remedy for all of the foregoing shall be limited to the greater of the amount actually paid by you separately for the Software Product or U.S. \$5.00. TO THE MAXIMUM EXTENT PERMITTED BY APPLICABLE LAW, IN NO EVENT SHALL HP OR ITS SUPPLIERS BE LIABLE FOR ANY SPECIAL, INCIDENTAL, INDIRECT, OR CONSEQUENTIAL DAMAGES WHATSOEVER (INCLUDING, BUT NOT LIMITED TO, DAMAGES FOR LOSS OF PROFITS OR CONFIDENTIAL OR OTHER INFORMATION, FOR BUSINESS INTERRUPTION, FOR PERSONAL INJURY, FOR LOSS OF PRIVACY ARISING OUT OF OR IN ANY WAY RELATED TO THE USE OF OR INABILITY TO USE THE SOFTWARE PRODUCT, OR OTHERWISE IN CONNECTION WITH ANY PROVISION OF THIS EULA, EVEN IF HP OR ANY SUPPLIER HAS BEEN ADVISED OF THE POSSIBILITY OF SUCH DAMAGES AND EVEN IF THE REMEDY FAILS OF ITS ESSENTIAL PURPOSE. Some states/jurisdictions do not allow the exclusion or limitation of incidental or consequential damages, so the above limitation or exclusion may not apply to you.
- 11. **U.S. GOVERNMENT CUSTOMERS.** Consistent with FAR 12.211 and 12.212, Commercial Computer Software, Computer Software Documentation, and Technical Data for Commercial Items are licensed to the U.S. Government under HP's standard commercial license.
- 12. **COMPLIANCE WITH EXPORT LAWS.** You shall comply with all laws and regulations of the United States and other countries ("Export Laws") to assure that the Software Product is not (1) exported, directly or

indirectly, in violation of Export Laws, or (2) used for any purpose prohibited by Export Laws, including, without limitation, nuclear, chemical, or biological weapons proliferation.

- 13. CAPACITY AND AUTHORITY TO CONTRACT.** You represent that you are of the legal age of majority in your state of residence and, if applicable, you are duly authorized by your employer to enter into this contract.
- 14. APPLICABLE LAW.** This EULA is governed by the laws of the country in which the equipment was purchased.
- 15. ENTIRE AGREEMENT.** This EULA (including any addendum or amendment to this EULA which is included with the HP Product) is the entire agreement between you and HP relating to the Software Product and it supersedes all prior or contemporaneous oral or written communications, proposals and representations with respect to the Software Product or any other subject matter covered by this EULA. To the extent the terms of any HP policies or programs for support services conflict with the terms of this EULA, the terms of this EULA shall control.
- 16. CONSUMER RIGHTS.** Consumers in some countries, states or territories may have the benefit of certain statutory rights and remedies under consumer legislation in respect of which HP's liability cannot lawfully be excluded or limited. If you acquired the Software as a consumer within the meaning of relevant consumer legislation in your country, state or territory, the provisions of this EULA (including the disclaimers of warranties, limitations and exclusions of liability) must be read subject to applicable law and apply only to the maximum extent permitted by that applicable law.

Australian Consumers: If you acquired the Software as a consumer within the meaning of the 'Australian Consumer Law' under the Australian Competition and Consumer Act 2010 (Cth) then despite any other provision of this EULA:

- a.** the Software comes with guarantees that cannot be excluded under the Australian Consumer Law, including that goods will be of acceptable quality and services will be supplied with due care and skill. You are entitled to a replacement or refund for a major failure and compensation for any other reasonably foreseeable loss or damage. You are also entitled to have the Software repaired or replaced if it is not of acceptable quality and the failure does not amount to a major failure
- b.** nothing in this EULA excludes, restricts or modifies any right or remedy, or any guarantee, warranty or other term or condition implied or imposed by the Australian Consumer Law which cannot be lawfully excluded or limited; and
- c.** the benefits provided to you by the express warranties in this EULA are in addition to other rights and remedies available to you under the Australian Consumer Law. Your rights under the Australian Consumer Law prevail to the extent that they are inconsistent with any limitations contained in the express warranty.

The Software may be capable of retaining user-generated data. HP hereby provides you with notice that if HP repairs your Software, that repair may result in the loss of that data. To the full extent permitted by law, the limitations and exclusions of HP's liability in this EULA apply in respect of any such loss of data.

If you think that you are entitled to any warranty under this agreement or any of the above remedies, please contact HP:

HP PPS Australia Pty Ltd
Building F, 1 Homebush Bay Drive
Rhodes, NSW 2138 Australia

To initiate a support request or warranty claim, please call 13 10 47 (within Australia) or +61 2 8278 1039 (if dialing internationally) or visit www8.hp.com/au/en/contact-hp/phone-assist.html for the most current list of phone support numbers.

If you are a consumer within the meaning of the Australia Consumer Law and you are purchasing the Software or warranty and support services for the Software which are not of a kind ordinarily acquired for personal, domestic or household use or consumption, then despite any other provision of this EULA, HP limits its liability for failure to comply with a consumer guarantee as follows:

- a. provision of warranty or support services for the Software: to any one or more of the following: re-supply of the services or payment of the costs of having the services re-supplied;
- b. provision of the Software: to any one or more of the following: replacement of the Software or the supply of equivalent software; repair of the Software; payment of the costs of replacing the Software or of acquiring equivalent software; or payment of the costs of having the Software repaired; and
- c. otherwise, to the maximum extent permitted by law.

New Zealand Consumers: In New Zealand, the Software comes with guarantees that cannot be excluded under the Consumer Guarantees Act 1993. In New Zealand, Consumer Transaction means a transaction involving a person who is purchasing goods for personal, domestic or household use or consumption and not for the purpose of a business. New Zealand consumers who are purchasing goods for personal, domestic or household use or consumption and not for the purpose of a business ("New Zealand Consumers") are entitled to repair, replacement or refund for a failure and compensation for other reasonably foreseeable loss or damage. A New Zealand Consumer (as defined above) may recover the costs of returning the product to the place of purchase if there is a breach of the New Zealand consumer law; furthermore, if it will be of significant cost to the New Zealand Consumer to return the goods to HP then HP will collect such goods at its own cost. Where any supply of products or services is for business purposes, you agree that the Consumer Guarantees Act 1993 does not apply and that given the nature and value of the transaction, this is fair and reasonable.

© Copyright 2020 HP Development Company, L.P.

The information contained herein is subject to change without notice. All other product names mentioned herein may be trademarks of their respective companies. To the extent permitted by applicable law, the only warranties for HP products and services are set forth in the express warranty statements accompanying such products and services. Nothing herein should be construed as constituting an additional warranty. To the extent permitted by applicable law, HP shall not be liable for technical or editorial errors or omissions contained herein.

Version: March 2020

Customer self-repair warranty service

HP products are designed with many Customer Self Repair (CSR) parts to minimize repair time and allow for greater flexibility in performing defective parts replacement. If during the diagnosis period, HP identifies that the repair can be accomplished by the use of a CSR part, HP will ship that part directly to you for replacement. There are two categories of CSR parts: 1) Parts for which customer self repair is mandatory. If you request HP to replace these parts, you will be charged for the travel and labor costs of this service. 2) Parts for which customer self repair is optional. These parts are also designed for Customer Self Repair. If, however, you require that HP replace them for you, this may be done at no additional charge under the type of warranty service designated for your product.

Based on availability and where geography permits, CSR parts will be shipped for next business day delivery. Same-day or four-hour delivery may be offered at an additional charge where geography permits. If assistance is required, you can call the HP Technical Support Center and a technician will help you over the phone. HP specifies in the materials shipped with a replacement CSR part whether a defective part must be returned to HP. In cases where it is required to return the defective part to HP, you must ship the defective part back to HP within a defined period of time, normally five (5) business days. The defective part must be returned with the associated documentation in the provided shipping material. Failure to return the defective part may result in HP billing you for the replacement. With a customer self repair, HP will pay all shipping and part return costs and determine the courier/carrier to be used.

Customer support

Get telephone support for your country/region	Country/region phone numbers are on the flyer that was in the box with your product or at www.support.hp.com .
Have the product name, serial number, date of purchase, and problem description ready.	
Get 24-hour Internet support, and download software utilities and drivers	www.support.hp.com
Order additional HP service or maintenance agreements	www.hp.com/go/carepack
Register your product	www.register.hp.com

C Environmental product stewardship program

- [Protecting the environment](#)
- [Ozone production](#)
- [Power consumption](#)
- [Paper use](#)
- [Plastics](#)
- [HP Neverstop printing supplies](#)
- [Paper](#)
- [Material restrictions](#)
- [Battery information](#)
- [Disposal of waste equipment by users \(EU and India\)](#)
- [Electronic hardware recycling](#)
- [Hardware recycling information \(Brazil\)](#)
- [Chemical substances](#)
- [Product Power Data per European Union Commission Regulation 1275/2008](#)
- [SEPA Ecolabel User Information \(China\)](#)
- [The regulation of the implementation on China energy label for printer, fax, and copier](#)
- [Restriction of Hazardous Substances statement \(India\)](#)
- [WEEE \(Turkey\)](#)
- [The Table of Hazardous Substances/Elements and their Content \(China\)](#)
- [Material Safety Data Sheet \(MSDS\)](#)
- [EPEAT](#)
- [Declaration of the Presence Condition of the Restricted Substances Marking \(Taiwan\)](#)
- [For more information](#)

Protecting the environment

HP is committed to providing quality products in an environmentally sound manner. This product has been designed with several attributes to minimize impacts on our environment.

Ozone production

The airborne emissions of ozone for this product have been measured according to a standardized protocol and when these emissions data are applied to an anticipated high-use scenario in an office workspace, HP has determined there is no appreciable amount of ozone generated during printing and the levels are well within current indoor air quality standards and guidelines.

References -

Test method for the determination of emissions from hardcopy devices with respect to awarding the environmental label for office devices with printing function; DE-UZ 205 – BAM; January 2018.

Based on ozone concentration when printing 2 hours per day in 30.6 cubic meter room with a ventilation rate of 0.68 air changes per hour with HP printing supplies.

Power consumption

Power usage drops significantly while in Ready, Sleep, or Off mode, which saves natural resources and saves money without affecting the high performance of this product. HP printing and imaging equipment marked with the ENERGY STAR® logo is qualified to the U.S. Environmental Protection Agency's ENERGY STAR specifications for imaging equipment. The following mark will appear on ENERGY STAR qualified imaging products:



Additional ENERGY STAR qualified imaging product model information is listed at:

www.hp.com/go/energystar

Paper use

This product's duplex feature (manual or automatic) and N-up printing (multiple pages printed on one page) capability can reduce paper usage and the resulting demands on natural resources.

Plastics

Plastic parts over 25 grams are marked according to international standards that enhance the ability to identify plastics for recycling purposes at the end of the product's life.

HP Neverstop printing supplies

Original HP Neverstop printing supplies were designed with the environment in mind. HP makes it easy to conserve resources and paper when printing. And when you are done, we make it easy and free to recycle.¹

All HP Toner Reload Kits and HP Laser Imaging Drums returned to HP Planet Partners go through a multiphase recycling process where materials are separated and refined for use as raw material in new Original HP Toner Reload Kits and HP Laser Imaging Drums and everyday products. No Original HP Toner Reload Kits and HP Laser Imaging Drums returned through HP Planet Partners are ever sent to a landfill, and HP never refills and resells Original HP Toner Reload Kits or HP Laser Imaging Drums.

To participate in HP Planet Partners return and recycling program, visit www.hp.com/recycle. Select your country/region for information on how to return HP printing supplies. Multi-lingual program information and instructions are also included in every new HP Toner Reload Kit and HP Laser Imaging Drum package.

¹ Program availability varies. For more information, visit www.hp.com/recycle.

Paper

This product is capable of using recycled paper and lightweight paper (EcoFFICIENT™) when the paper meets the guidelines outlined in the *HP Laser Printer Family Print Media Guide*. This product is suitable for the use of recycled paper and lightweight paper (EcoFFICIENT™) according to EN12281:2002.

Material restrictions

This HP product does not contain added mercury.

Battery information

This product may contain a:

- Poly-carbonmonofluoride lithium (BR type) or
- Manganese dioxide lithium (CR type)

battery that may require special handling at end of life.

 **NOTE:** (For CR type only) Perchlorate material - special handling may apply. See dtsc.ca.gov/hazardouswaste/perchlorate.

Weight: ~3 g

Location: On motherboard

User Removable: No



廢電池請回收

For recycling information, you can go to www.hp.com/recycle, or contact your local authorities or the Electronics Industries Alliance: www.eiae.org.

Disposal of waste equipment by users (EU and India)



This symbol means do not dispose of your product with your other household waste. Instead, you should protect human health and the environment by handing over your waste equipment to a designated collection point for the recycling of waste electrical and electronic equipment. For more information, please contact your household waste disposal service, or go to: www.hp.com/recycle.

Electronic hardware recycling

HP encourages customers to recycle used electronic hardware. For more information about recycling programs go to: www.hp.com/recycle.

Hardware recycling information (Brazil)



**Não descarte o
produto eletrônico
em lixo comum**

Este produto eletrônico e seus componentes não devem ser descartados no lixo comum, pois embora estejam em conformidade com padrões mundiais de restrição a substâncias nocivas, podem conter, ainda que em quantidades mínimas, substâncias impactantes ao meio ambiente. Ao final da vida útil deste produto, o usuário deverá entregá-lo à HP. A não observância dessa orientação sujeitará o infrator às sanções previstas em lei.

Após o uso, as pilhas e/ou baterias dos produtos HP deverão ser entregues ao estabelecimento comercial ou rede de assistência técnica autorizada pela HP.

Para maiores informações, inclusive sobre os pontos de recebimento, acesse:

www.hp.com.br/reciclar

Chemical substances

HP is committed to providing our customers with information about the chemical substances in our products as needed to comply with legal requirements such as REACH (Regulation EC No 1907/2006 of the European Parliament and the Council). A chemical information report for this product can be found at: www.hp.com/go/reach.

Product Power Data per European Union Commission Regulation 1275/2008

For product power data, including the power consumption of the product in networked standby if all wired network ports are connected and all wireless network ports are activated, please refer to section P14 'Additional Information' of the product IT ECO Declaration at www.hp.com/hpinfo/globalcitizenship/environment/productdata/itecodesktop-pc.html.

SEPA Ecolabel User Information (China)

中国环境标识认证产品用户说明

噪声大于 63.0 dB(A)的办公设备不宜放置于办公室内，请在独立的隔离区域使用。

如需长时间使用本产品或打印大量文件，请确保在通风良好的房间内使用。

如您需要确认本产品处于零能耗状态，请按下电源关闭按钮，并将插头从电源插座断开。

您可以使用再生纸，以减少资源耗费。

The regulation of the implementation on China energy label for printer, fax, and copier

依据“复印机、打印机和传真机能源效率标识实施规则”，本打印机具有中国能效标签。根据“复印机、打印机和传真机能效限定值及能效等级”（“GB21521”）决定并计算得出该标签上所示的能效等级和 TEC（典型能耗）值。

1. 能效等级

能效等级分为三个等级，等级 1 级能效最高。根据产品类型和打印速度标准决定能效限定值。

2. 能效信息

2.1 激光打印机及一体机和高性能喷墨打印机及一体机

- 典型能耗

典型能耗是正常运行 GB21521 测试方法中指定的时间后的耗电量。此数据表示为每周千瓦时 (kWh)。

标签上所示的能效数字按涵盖根据“复印机、打印机和传真机能源效率标识实施规则”选择的登记装置中所有配置的代表性配置测定而得。因此，本特定产品型号的实际能耗可能与标签上所示的数据不同。

有关规范的详情信息，请参阅 GB21521 标准的当前版本。

Restriction of Hazardous Substances statement (India)

This product, as well as its related consumables and spares, complies with the reduction in hazardous substances provisions of the "India E-waste Rule 2016." It does not contain lead, mercury, hexavalent chromium, polybrominated biphenyls or polybrominated diphenyl ethers in concentrations exceeding 0.1 weight % and 0.01 weight % for cadmium, except where allowed pursuant to the exemptions set in Schedule 2 of the Rule.

WEEE (Turkey)

Türkiye Cumhuriyeti: AEEE Yönetmeliğine Uygundur

The Table of Hazardous Substances/Elements and their Content (China)

产品中有害物质或元素的名称及含量

根据中国《电器电子产品有害物质限制使用管理办法》



部件名称	有害物质					
	铅 (Pb)	汞 (Hg)	镉 (Cd)	六价铬 (Cr(VI))	多溴联苯 (PBB)	多溴二苯醚 (PBDE)
外壳和托盘	○	○	○	○	○	○
电线	○	○	○	○	○	○
印刷电路板	X	○	○	○	○	○
打印系统	X	○	○	○	○	○
显示器	X	○	○	○	○	○
喷墨打印机墨盒	○	○	○	○	○	○
驱动光盘	X	○	○	○	○	○
扫描仪	X	○	○	○	○	○
网络配件	X	○	○	○	○	○
电池板	X	○	○	○	○	○
自动双面打印系统	○	○	○	○	○	○
外部电源	X	○	○	○	○	○

本表格依据 SJ/T 11364 的规定编制。

○：表示该有害物质在该部件所有均质材料中的含量均在 GB/T 26572 规定的限量要求以下。

X：表示该有害物质至少在该部件的某一均质材料中的含量超出 GB/T 26572 规定的限量要求。

此表中所有名称中含“X”的部件均符合中国 RoHS 达标管理目录限用物质应用例外清单的豁免。

此表中所有名称中含“X”的部件均符合欧盟 RoHS 立法。

注：环保使用期限的参考标识取决于产品正常工作的温度和湿度等条件。

Material Safety Data Sheet (MSDS)

Material Safety Data Sheets (MSDS) for supplies containing chemical substances (for example, toner) can be obtained by accessing the HP Web site at www.hp.com/go/msds.

EPEAT

Many HP products are designed to meet EPEAT. EPEAT is a comprehensive environmental rating that helps identify greener electronics equipment. For more information on EPEAT go to www.epeat.net. For information on HP's EPEAT registered products go to www.hp.com/hpinfo/globalcitizenship/environment/pdf/epeat_printers.pdf.

Declaration of the Presence Condition of the Restricted Substances Marking (Taiwan)

台灣 限用物質含有情況標示聲明書

Taiwan Declaration of the Presence Condition of the Restricted Substances Marking

單元 Unit	限用物質及其化學符號 Restricted substances and their chemical symbols					
	鉛 (Pb)	汞 (Hg)	鎘 (Cd)	六價鉻 (Cr ⁺⁶)	多溴聯苯 (PBB)	多溴二苯聯 (PBDE)
	列印引擎 Print engine	—	○	○	○	○
外殼和紙匣 External casing and trays	○	○	○	○	○	○
電源供應器 Power supply	—	○	○	○	○	○
電線 Cables	○	○	○	○	○	○
印刷電路板 Printed circuit board	—	○	○	○	○	○
控制面板 Control panel	—	○	○	○	○	○
墨水匣 Cartridge	○	○	○	○	○	○
掃描器組件 Scanner assembly	—	○	○	○	○	○

備考 1. “超出 0.1 wt %” 及 “超出 0.01 wt %” 係指限用物質之百分比含量超出百分比含量基準值。
Note 1: “Exceeding 0.1 wt %” and “exceeding 0.01 wt %” indicate that the percentage content of the restricted substance exceeds the reference percentage value of presence condition.

備考 2. “○” 係指該項限用物質之百分比含量未超出百分比含量基準值。
Note 2: “○” indicates that the percentage content of the restricted substance does not exceed the percentage of reference value of presence.

備考 3. “—” 係指該項限用物質為排除項目。
Note 3: “—” indicates that the restricted substance corresponds to the exemption.

若要存取產品的最新使用指南或手冊，請前往 www.support.hp.com。選取搜尋您的產品，然後依照畫面上的指示繼續執行。

To access the latest user guides or manuals for your product, go to www.support.hp.com. Select **Find your product**, and then follow the onscreen instructions.

For more information

To obtain information about these environmental topics:

- Product environmental profile sheet for this and many related HP products
- HP's commitment to the environment
- HP's environmental management system
- HP's end-of-life product return and recycling program
- Material Safety Data Sheets

Visit www.hp.com/go/environment.

Also, visit www.hp.com/recycle.

D Regulatory information

- [Regulatory statements](#)
- [Wireless statements](#)

Regulatory statements

European Union Regulatory Notice

Products bearing the CE marking comply with one or more of the following EU Directives as may be applicable: Low Voltage Directive 2014/35/EU, EMC Directive 2014/30/EU, Eco Design Directive 2009/125/EC, RED 2014/53/EU, RoHS Directive 2011/65/EU.



Compliance with these directives is assessed using applicable European Harmonized Standards. The full Declaration of Conformity can be found at the following website: www.hp.com/go/certificates (Search with the product model name or its Regulatory Model Number (RMN), which may be found on the regulatory label.)

The point of contact for regulatory matters is: HP Deutschland GmbH, HP HQ-TRE, 71025 Boeblingen, Germany

Regulatory model identification numbers

For regulatory identification purposes, your product is assigned a regulatory model number. Regulatory model numbers should not be confused with marketing names or product numbers.

Product model number	Regulatory model number
HP Neverstop Laser 1000a,1000n	SEOLA-1800-00
HP Neverstop Laser 1000w,1001nw	SEOLA-1800-01

FCC regulations

This equipment has been tested and found to comply with the limits for a Class B digital device, pursuant to Part 15 of the FCC rules. These limits are designed to provide reasonable protection against harmful interference in a residential installation. This equipment generates, uses, and can radiate radio frequency energy. If this equipment is not installed and used in accordance with the instructions, it may cause harmful interference to radio communications. However, there is no guarantee that interference will not occur in a particular installation. If this equipment does cause harmful interference to radio or television reception, which can be determined by turning the equipment off and on, the user is encouraged to try to correct the interference by one or more of the following measures:

- Reorient or relocate the receiving antenna.
- Increase separation between equipment and receiver.
- Connect equipment to an outlet on a circuit different from that to which the receiver is located.
- Consult your dealer or an experienced radio/TV technician.



NOTE: Any changes or modifications to the printer that are not expressly approved by HP could void the user's authority to operate this equipment.

Use of a shielded interface cable is required to comply with the Class B limits of Part 15 of FCC rules.

Canada - Industry Canada ICES-003 Compliance Statement

CAN ICES-3(B)/NMB-3(B)

Power cord instructions

Make sure your power source is adequate for the product voltage rating. The voltage rating is on the product label. The product uses either 110-127 Vac or 220-240 Vac and 50/60 Hz.

Connect the power cord between the product and a grounded AC outlet.

 **CAUTION:** To prevent damage to the product, use only the power cord that is provided with the product.

Laser safety

The Center for Devices and Radiological Health (CDRH) of the U.S. Food and Drug Administration has implemented regulations for laser products manufactured since August 1, 1976. Compliance is mandatory for products marketed in the United States. The device is certified as a “Class 1” laser product under the U.S. Department of Health and Human Services (DHHS) Radiation Performance Standard according to the Radiation Control for Health and Safety Act of 1968. Since radiation emitted inside the device is completely confined within protective housings and external covers, the laser beam cannot escape during any phase of normal user operation.

 **WARNING!** Using controls, making adjustments, or performing procedures other than those specified in this user guide may result in exposure to hazardous radiation.

Laser statement for Finland

Luokan 1 laserlaite

HP Neverstop Laser 1000a, 1000w, 1000n, 1001nw, laserkirjoitin on käyttäjän kannalta turvallinen luokan 1 laserlaite. Normaalisessa käytössä kirjoittimen suojakotelointi estää lasersäteiden pääsyn laitteen ulkopuolelle. Laitteen turvallisuusluokka on määritetty standardin EN 60825-1 (2014) mukaisesti.

VAROITUS !

Laitteen käyttäminen muulla kuin käyttöohjeessa mainitulla tavalla saattaa altistaa käyttäjän turvallisuusluokan 1 ylittävälle näkymättömälle lasersäteilylle.

WARNING !

Om apparaten används på annat sätt än i bruksanvisning specificerats, kan användaren utsättas för osynlig laserstrålning, som överskrider gränsen för laserklass 1.

HUOLTO

HP Neverstop Laser 1000a, 1000w, 1000n, 1001nw - kirjoittimen sisällä ei ole käyttäjän huollettavissa olevia kohteita. Laitteen saa avata ja huoltaa ainoastaan sen huoltamiseen koulutettu henkilö. Tällaiseksi huoltotoimenpiteeksi ei katsota väriainekasetin vaihtamista, paperiradan puhdistusta tai muita käyttäjän käsikirjassa lueteltuja, käyttäjän tehtäväksi tarkoitettuja ylläpitotoimia, jotka voidaan suorittaa ilman erikoistyökaluja.

VARO !

Mikäli kirjoittimen suojakotelo avataan, olet alttiina näkymättömälle lasersäteilylle laitteen ollessa toiminnassa. Älä katso säteeseen.

WARNING !

Om laserprinterns skyddshölje öppnas då apparaten är i funktion, utsättas användaren för osynlig laserstrålning. Betrakta ej strålen.

Tiedot laitteessa käytettävän laseriodin säteilyominaisuuksista: Aallonpituus 775-795 nm Teho 5 m W Luokan 3B laser.

Nordic Statements (Denmark, Finland, Norway, Sweden)

Denmark:

Apparatets stikprop skal tilsættes en stikkontakt med jord, som giver forbindelse til stikproppens jord.

Finland:

Laite on liitettävä suojakoskettimilla varustettuun pistorasiaan.

Norway:

Apparatet må tilkoples jordet stikkontakt.

Sweden:

Apparaten skall anslutas till jordat uttag.

Eurasian Conformity (Armenia, Belarus, Kazakhstan, Kirgizstan, Russia)

Производитель и дата производства



HP Inc.

Адрес: 1501 Page Mill Road, Palo Alto, California 94304, U.S.

Дата производства зашифрована в 10-значном серийном номере, расположенном на наклейке со служебной информацией изделия. 4-я, 5-я и 6-я цифры обозначают год и неделю производства. 4-я цифра обозначает год, например, «3» обозначает, что изделие произведено в «2013» году. 5-я и 6-я цифры обозначают номер недели в году производства, например, «12» обозначает «12-ю» неделю.

Өндіруші және өндіру мерзімі

HP Inc.

Мекенжайы: 1501 Page Mill Road, Palo Alto, California 94304, U.S.

Өнімнің жасалу мерзімін табу үшін өнімнің қызмет көрсету жапсырмасындағы 10 таңбадан тұратын сериялық нөмірін қараңыз. 4-ші, 5-ші және 6-шы сандар өнімнің жасалған жылы мен аптасын көрсетеді. 4-ші сан жылын көрсетеді, мысалы «3» саны «2013» дегенді білдіреді. 5-ші және 6-шы сандары берілген жылдың қай аптасында жасалғанын көрсетеді, мысалы, «12» саны «12-ші» апта дегенді білдіреді.

Местные представители

Россия: 000 "Эйч Пи Инк",

Российская Федерация, 125171, г. Москва, Ленинградское шоссе, 16А, стр.3,

Телефон/факс: +7 495 797 35 00 / +7 499 92132 50

Казахстан: Филиал компании "ЭйчПи Глобал Трейдинг Би.Ви.", Республика Казахстан, 050040, г. Алматы, Бостандыкский район, проспект Аль-Фараби, 77/7,

Телефон/факс: +7 7 27 355 35 52

Жергілікті өкілдіктері

Ресей: 000 "Эйч Пи Инк",

Ресей Федерациясы, 125171, Мәскеу, Ленинград шоссесі, 16А блок 3,

Телефон/факс: +7 495 797 35 00 / +7 499 92132 50

Қазақстан: "ЭйчПи Глобал Трейдинг Би.Ви." компаниясының Қазақстандағы филиалы, Қазақстан Республикасы, 050040, Алматы к., Бостандық ауданы, Әл-Фараби даңғылы, 77/7,

Телефон/факс: +7 727 355 35 52

Wireless statements

The statements in this section apply to wireless-capable printer models only.

FCC compliance statement—United States

Exposure to radio frequency radiation

⚠ CAUTION: The radiated output power of this device is far below the FCC radio frequency exposure limits. Nevertheless, the device shall be used in such a manner that the potential for human contact during normal operation is minimized.

In order to avoid the possibility of exceeding the FCC radio frequency exposure limits, human proximity to the antenna shall not be less than 20 cm (8 in) during normal operation.

This device complies with Part 15 of FCC Rules. Operation is subject to the following two conditions: (1) this device may not cause interference, and (2) this device must accept any interference, including interference that may cause undesired operation of the device.

⚠ CAUTION: Based on Section 15.21 of the FCC rules, changes of modifications to the operation of this product without the express approval by HP may invalidate its authorized use.

Brazil ANATEL statement

Este equipamento opera em caráter secundário, isto é, não tem direito à proteção contra interferência prejudicial, mesmo de estações do mesmo tipo, e não pode causar interferência a sistemas operando em caráter primário.

Canadian statements

For Indoor Use. This digital apparatus does not exceed the Class B limits for radio noise emissions from digital apparatus as set out in the radio interference regulations of the Canadian Department of Communications. The internal wireless radio complies with RSS 210 of Industry Canada.

Pour l'usage d'intérieur. Le présent appareil numérique n'émet pas de bruits radioélectriques dépassant les limites applicables aux appareils numériques de Classe B prescrites dans le règlement sur le brouillage radioélectrique édicté par le Ministère des Communications du Canada. Le composant RF interne est conforme à la norme CNR-210 d'Industrie Canada.

Products with 5 GHz Operation Industry of Canada

⚠ CAUTION: When using IEEE 802.11a wireless LAN, this product is restricted to indoor use, due to its operation in the 5.15- to 5.25-GHz frequency range. Industry Canada requires this product to be used indoors for the frequency range of 5.15 GHz to 5.25 GHz to reduce the potential for harmful interference to co-channel mobile satellite systems. High-power radar is allocated as the primary user of the 5.25- to 5.35-GHz and 5.65- to 5.85-GHz bands. These radar stations can cause interference with and/or damage to this device.

Exposure to Radio Frequency Radiation (Canada)

⚠ WARNING! Exposure to Radio Frequency Radiation. The radiated output power of this device is below the Industry Canada radio frequency exposure limits. Nevertheless, the device should be used in such a manner that the potential for human contact is minimized during normal operation.

To avoid the possibility of exceeding the Industry Canada radio frequency exposure limits, human proximity to the antennas should not be less than 20 cm (8 inches).

European Union regulatory notice

The telecommunications functionality of this product may be used in the following EU and EFTA countries/ regions:

Austria, Belgium, Bulgaria, Cyprus, Czech Republic, Denmark, Estonia, Finland, France, Germany, Greece, Hungary, Iceland, Ireland, Italy, Latvia, Liechtenstein, Lithuania, Luxembourg, Malta, Netherlands, Norway, Poland, Portugal, Romania, Slovak Republic, Slovenia, Spain, Sweden, Switzerland, and United Kingdom.

Notice for use in Russia

Существуют определенные ограничения по использованию беспроводных сетей (стандарта 802.11 b/g) с рабочей частотой 2,4 ГГц: Данное оборудование может использоваться внутри помещений с использованием диапазона частот 2400-2483,5 МГц (каналы 1-13). При использовании внутри помещений максимальная эффективная изотропно-излучаемая мощность (ЭИИМ) должна составлять не более 100мВт.

Mexico statement

Aviso para los usuarios de México

“La operación de este equipo está sujeta a las siguientes dos condiciones: (1) es posible que este equipo o dispositivo no cause interferencia perjudicial y (2) este equipo o dispositivo debe aceptar cualquier interferencia, incluyendo la que pueda causar su operación no deseada.”

Para saber el modelo de la tarjeta inalámbrica utilizada, revise la etiqueta regulatoria de la impresora.

Vietnam Telecom wired/wireless marking for ICTQC Type approved products



Index

A

acoustic specifications 81
ANATEL statement 124
anticounterfeit supplies 98

B

bin, output
 jams, clearing 62
bins, output
 locating 2
browser requirements 16
buttons, control panel 3

C

Canadian notices
 ICES-003 compliance 120
checklist
 wireless connectivity 72
clearing jams
 locations 57
control panel
 buttons 3
 features 3
 LED light patterns 52
 locating 2
counterfeit supplies 98
covers, locating 2
customer support
 online 106
 warranty 50

D

defaults, restoring 55
dimensions, printer 81
double-sided printing 37
drivers, supported 79
duplexing 37

E

economy settings 20
electrical specifications 81
electronic hardware recycling 111
Embedded Web Server (EWS)
 assigning passwords 19
 features 16
envelope, loading 30
envelope, orientation 30
environmental stewardship
 program 107
Eurasian conformity 123

F

factory-set defaults, restoring 55
FCC compliance statement 124
Finnish laser safety statement 122

H

hardware recycling, Brazil 112
HP Customer Care 106
HP Device Toolbox, using 16
HP Embedded Web Server (EWS)
 features 16
HP EWS, using 16

I

ICES-003 notice 120
image quality issues
 examples and solutions 67
input tray
 jams, clearing 59
 locating 2
interface ports
 locating 2

J

jams
 locations 57

output-bin, clearing 62
tray, clearing 59

L

label
 orientation 32
labels
 printing on 32
labels, loading 32
laser safety 121
laser safety statements
 Finland 122
license, software 100

M

manual duplex
 Windows 37
Material Safety Data Sheet (MSDS)
 114
media
 ordering 48
memory chip, reload kit
 description 99
multiple pages per sheet
 printing (Windows) 37

N

network connection
 wireless connection 8
network port
 locating 2
networks
 supported 79
non-HP supplies 98
notices
 Brazil 124
 Canada 124
 CE mark 120
 EU 120

- European Union 125
- FCC 120, 124
- Mexico 125
- Nordic 122
- Russia 125
- United States of America 124
- Vietnam 125

O

- on/off button, locating 2
- online support 106
- operating systems (OS)
 - supported 79
- operating systems, supported 79
- ordering
 - supplies and accessories 48
- OS (operating system)
 - supported 79
- output bin
 - locating 2

P

- pages per sheet
 - selecting (Windows) 37
- paper
 - loading 25, 27
 - selecting 65
- paper jams. *See* jams
- paper pickup problems
 - solving 56
- paper type
 - selecting (Windows) 36
- paper, ordering 48
- power
 - consumption 81
- power connection
 - locating 2
- power cord
 - instructions 121
- power switch, locating 2
- power-down delay
 - setting 21
- print drivers, supported 79
- print on both sides
 - manually, Windows 37
- product and serial number label
 - locating 2

R

- recycling 109
 - electronic hardware 111

- reload kit
 - non-HP 98
 - recycling 109
 - warranty 97
- restoring factory-set defaults 55

S

- safety statements 121, 122
- SEOLA regulatory identification numbers 120
- serial number label
 - locating 2
- settings
 - factory-set defaults, restoring 55
- shut down after delay
 - setting 20
- single-sheet priority feed slot
 - loading labels 32
- sleep delay
 - disabling 20
 - enabling 20
- software
 - software license agreement 100
- specifications
 - electrical and acoustic 81
- status
 - control panel lights 52
- supplies
 - counterfeit 98
 - non-HP 98
 - ordering 48
 - recycling 109
 - used 98
- support
 - online 106
- system requirements 16

T

- technical support
 - online 106
- Toner Reload Kit
 - memory chips 99
 - non-HP 98
 - recycling 109
 - warranty 97
- troubleshooting
 - LED, errors 52
 - LED, light patterns 52

- paper feed problems 56
- wireless network 72

U

- USB port
 - locating 2
- used supplies 98

W

- warranty 50
 - customer self repair 105
 - license 100
 - product 86
 - Toner Reload Kit 97
- waste disposal 111
- web browser requirements
 - HP Embedded Web Server 16
- Web sites
 - counterfeit supplies 98
 - customer support 106
 - Material Safety Data Sheet (MSDS) 114
- weight, printer 81
- wireless network
 - troubleshooting 72
- wireless network interference 75